I-7532

Two-channel CAN Bus Bridge

User's Manual

Warranty

All products manufactured by ICP DAS are under warranty regarding defective materials for a period of one year from the date of delivery to the original purchaser.

Warning

ICP DAS assumes no liability for damages resulting from the use of this product. ICP DAS reserves the right to change this manual at any time without notice. The information furnished by ICP DAS is believed to be accurate and reliable. However, no responsibility is assumed by ICP DAS for its use, or for any infringements of patents or other rights of third parties resulting from its use.

Copyright

Copyright 1997 by ICP DAS. All rights are reserved.

Trademark

The names used for identification only may be registered trademarks of their respective companies.

Tables of Content

1	Introduction	3
1.1	Features.....	5
1.2	Specifications.....	5
1.3	Application	6
1.4	Information.....	6
2	Hardware	7
2.1	Block Diagram	7
2.2	Appearance	8
2.3	LED Indication	9
2.4	Reset & Error Clear Button	10
2.5	CANBaud Rotary Switch.....	11
2.5.1	BootLoader Mode.....	11
2.5.2	Communication Mode	12
2.5.3	Configuration Mode.....	13
2.5.4	Configuration via I-7532 Utility.....	15
2.5.5	Configuration via Sending Config Command	25
2.6	Pin Assignment.....	35
2.7	Wire Connection	38
2.8	Terminator Resistor Setting.....	39
3	Network deployment.....	40
3.1	Definition.....	40
3.2	Cable Selection.....	40
3.3	Driving Capability.....	41
3.4	Baud and Bus Length	41
3.5	Terminator Resistor.....	42
4	FAQ	43
	Q01: Firmware update problem in firmware v1.02.....	43
	Q02: How to set the CAN-ID Mapping ?	44
	Q03: How to set the CAN-ID Filter ?.....	47
5	History of Version.....	49

1 Introduction

I-7532 is a local CAN bridge used to establish a connection between two CAN bus system in a CAN network. I-7532 stands by itself connecting adjacent wiring segments together as in the case of a CAN repeater (I-7531). Not just like a CAN repeater, I-7532 has the following powerful features :

- (1) [Extend CAN bus network distance.](#)
- (2) [Connect two CAN bus networks with different baud rate.](#)
- (3) [Raise the number of node in CAN bus network.](#)
- (4) [Integrate multi the same CAN devices in the CAN network.](#)

The transmission distance limitation of the CAN bus system on each side of I-7532 is independent, which means the total CAN network distance can be extended like Figure 1-1.

Extend The Communication Network Distance

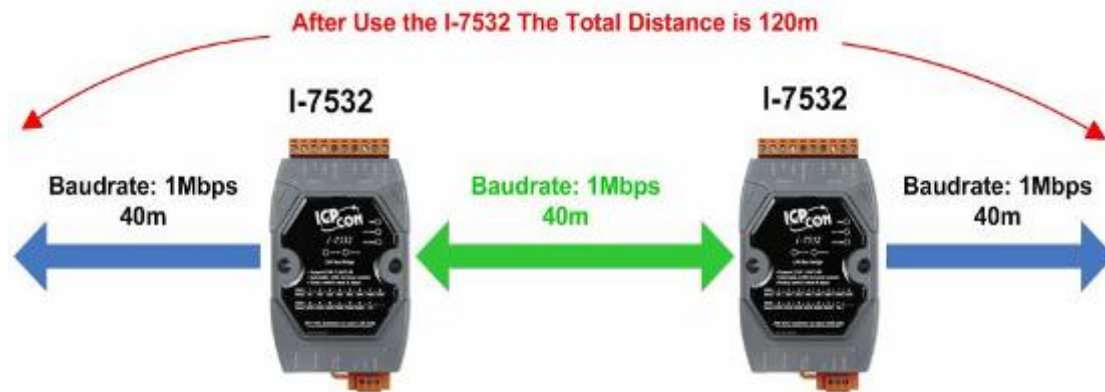

Figure 1-1: Application of I-7532 Extend Distance

The baudrate of two channels on I-7532 can be different for highly flexibility. On the other hand, when the CAN bus system on one side of I-7532 happens some error (e.g. bit error), the system on other side can still work on correctly like Figure 1-2.

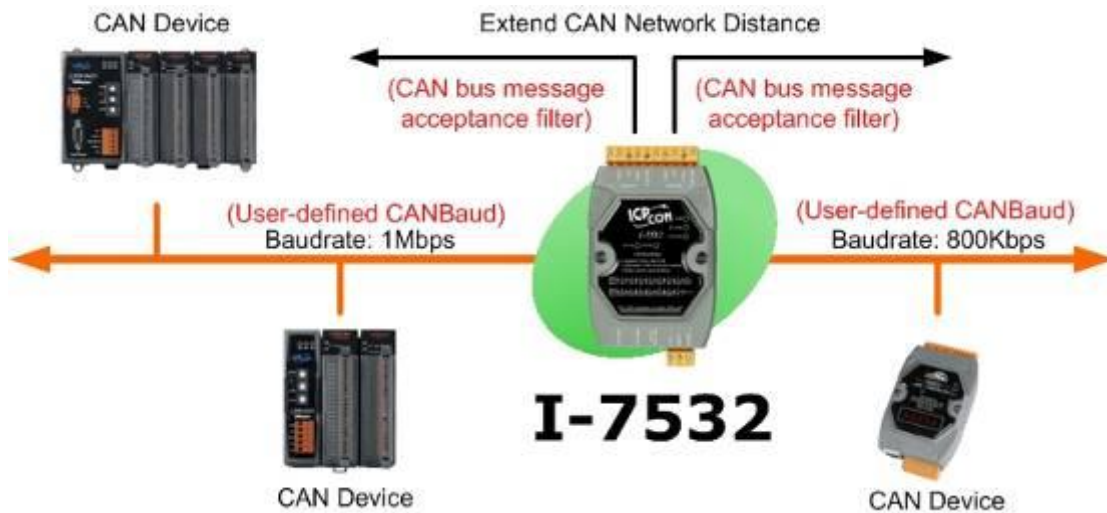

Figure1-2: Application of I-7532 Different Baud Connected

I-7532 can enhance the bus load capacity like Figure 1-3 and users can know how to increase driving capability by table 3-2.

Raise the number of node in the bus

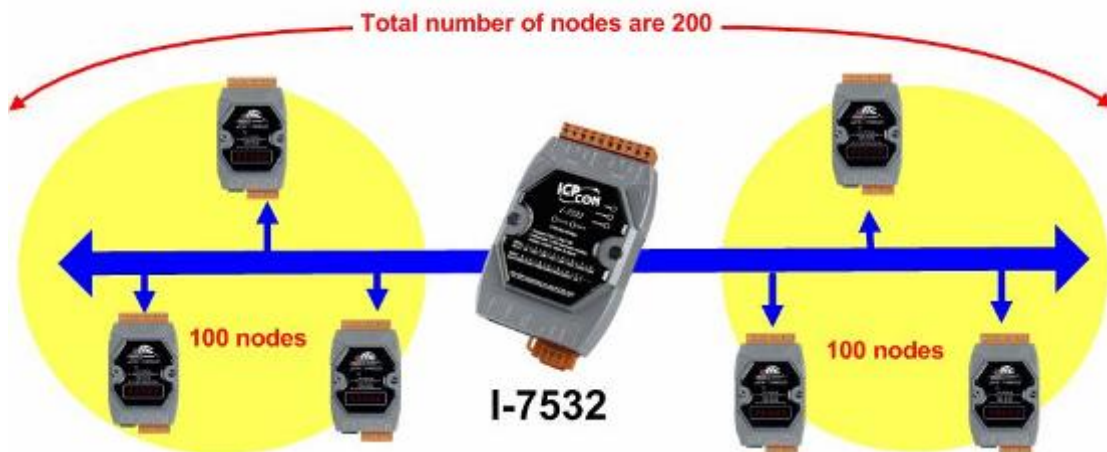

Figure 1-3: Application of I-7532 Raise nodes.

1.1 Features

- Fully compatible with the ISO 11898-2 standard.
- Support both CAN 2.0A and CAN 2.0B
- 82C250 CAN transceiver.
- 2500 Vrms photo-couple isolation on the CAN side.
- 3kV galvanic isolation between the power supply and two CAN channel.
- Selectable 120Ω terminator resistor by jumper
- Watchdog inside.
- Up to 100 CAN nodes on each channel.
- Transmission distance up to 1km on each CAN channel.
- Removable terminal block.
- Mountable on DIN Rail.
- 768 data frames for each CAN channel.
- The baud of each channel can be different for highly flexibility.
- Rotary switch for CAN baud rate from 5Kbps to 1Mbps or [programmable user-defined CAN baud rate](#). (For firmware **v1.01** or newer)
- Support CAN bus message [acceptance filter configuration](#). (For firmware **v1.01** or newer)
- Provide [I-7532 Utility for CAN bus message acceptance filter and user-defined CAN baud rate](#) etc. configuration easily and quickly.
- [Support firmware update via CAN1 of I-7532](#). (For firmware **v1.02** or newer)
- [CAN messages can be forwarded under another identifier](#). (For firmware **v1.03** or newer)
- [Support CAN Bus-Off Auto-Reset function](#). (For firmware **v1.04** and **Utility_v1.03** or newer)
- [Support CAN Listen-Only Mode function](#). (For firmware **v1.04** and **Utility_v1.03** or newer)

1.2 Specifications

- Power consumption: 2W max.
- Power Supply: +10 V_{DC} ~ +30 V_{DC}.
- Operating temperature: -25°C ~ +75°C.

-
- Humidity: 5% ~ 95%.
 - Dimensions: 122 mm x 72 mm x 35 mm
 - LEDs : PWR LED for power
RUN LED for communication
ERR LED for error

1.3 Application

- Factory Automation.
- Building Automation.
- Home Automation.
- Vehicle Automation.
- Control system.
- Monitor system.

1.4 Information

For more information about the I-7532, please visit ICP DAS website:

http://www.icpdas.com/products/Remote_IO/can_bus/i-7532.htm

2 Hardware

2.1 Block Diagram

The following block diagram illustrates the functions of I-7532 module. Power supply is with $3000V_{DC}$ galvanic isolated between each CAN port. Furthermore, there is photo-isolation $2500V_{RMS}$ between two CAN channels.

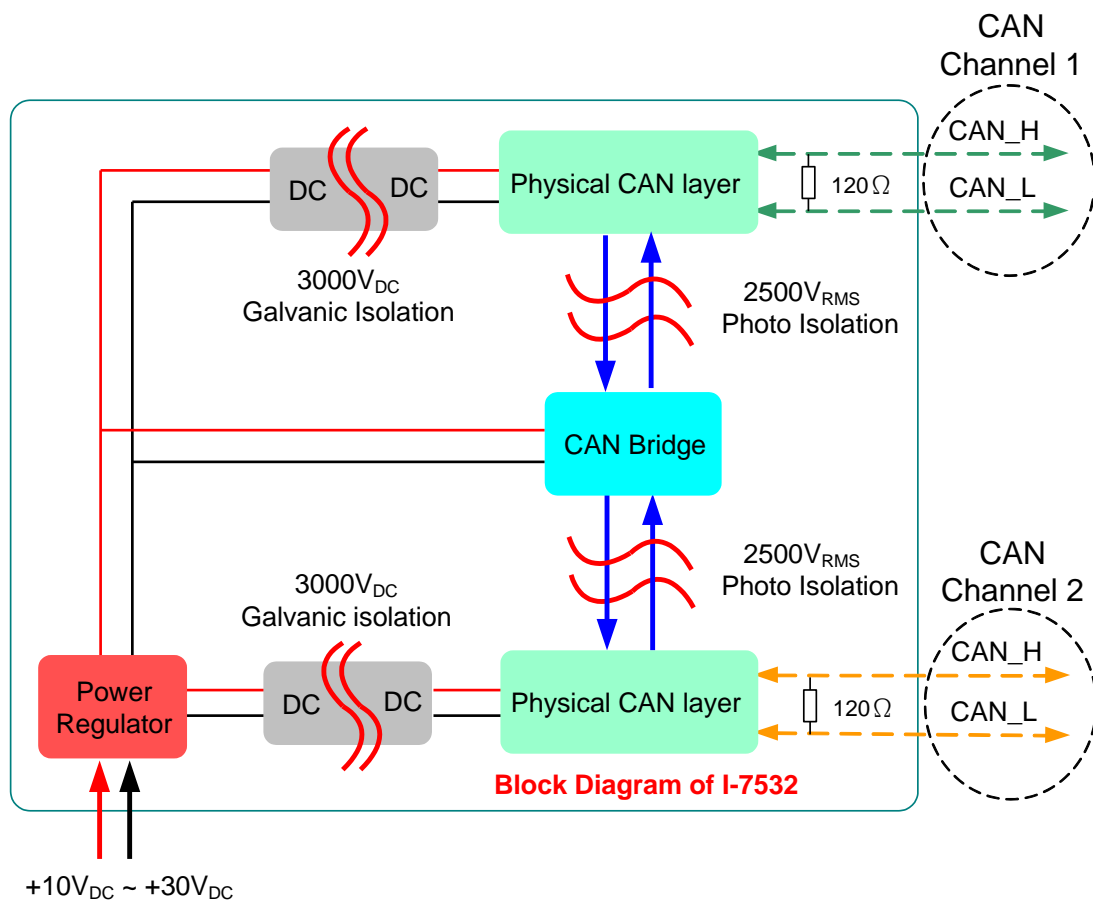

Figure 2-1: Block Diagram of I-7532

2.2 Appearance

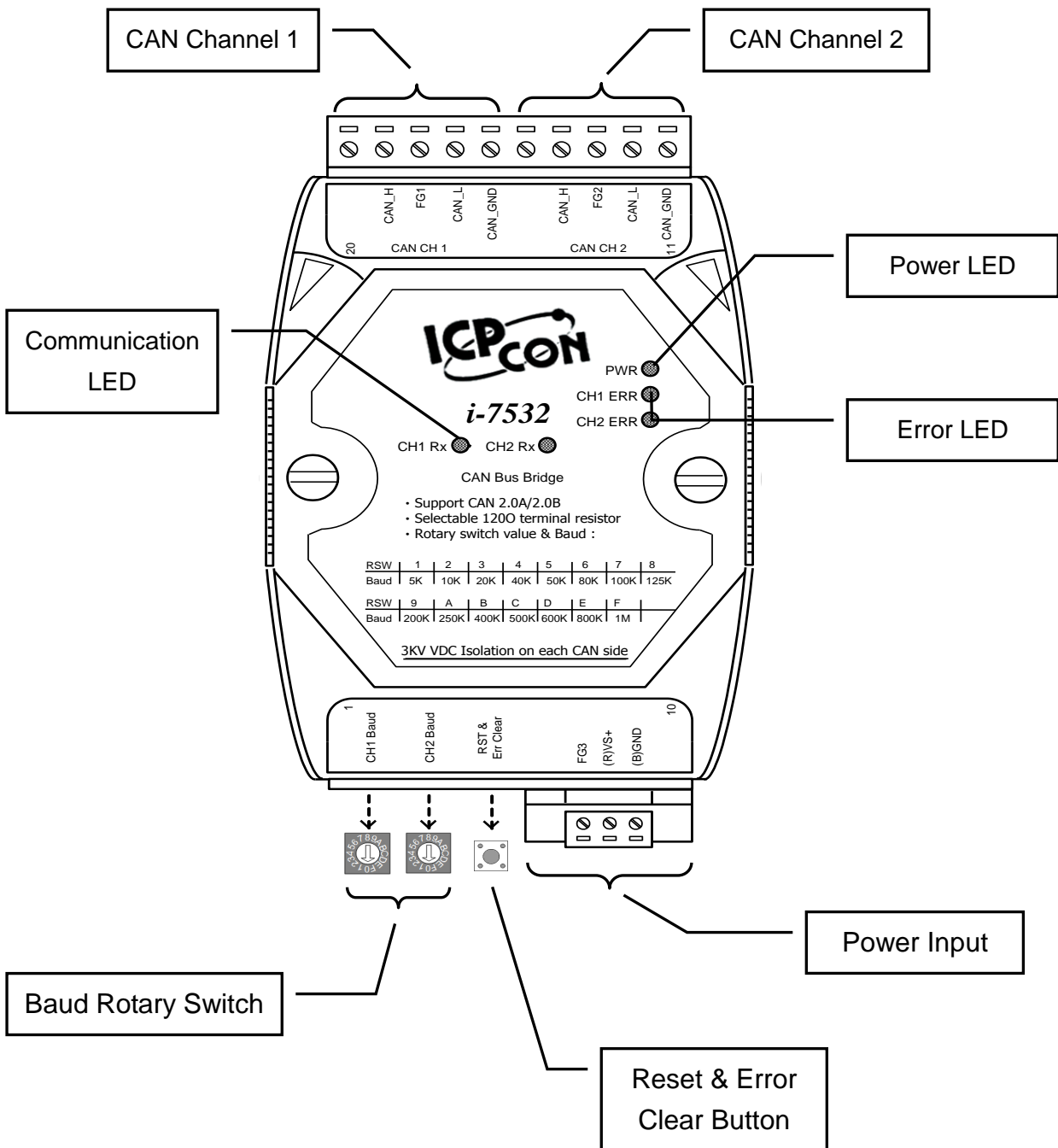

Figure2-2: Appearance of I-7532

2.3 LED Indication

Table2-1: LED Status Table

LED Name	I-7532 Status	LED Status
PWR LED	Bootloader Mode	Flash per second
	Configuration Mode	Flash per 100ms
	Communication Mode	Always turned on
	Power Off	Off
Rx LED	Module Configuration via this CAN Chnnel	Always turned on in config mode
	Transmission	Flash in comm. mode
	Bus Idle	Off in comm. mode
ERR LED	Transmission Fail	Flash per 100 ms
	Buffer Overflow	Flash per second
	Bus-Off	Always turned on
	No Error	Off

[Note]

1. When I-7532 is in Comm. mode, the PWR LED will turn on with red light.
2. If a CAN message passes through I-7532 from CH1 to CH2, the CH1 Rx LED will flash once with green light.
3. The following is the error conditions in comm. mode :

(1) Transmission Fail :

If CAN transmission fails on channel(x), the CH(x) ERR LED will flash continuously and the interval is about 100 ms.

(2) Buffer overflow :

If Tx buffer on CH(x) has been overflowed, the CH(x) ERR LED will flash per second continuously. Users can press the "RST" button once to clear the ERR LED.

(3) Bus Off :

If the bus-off condition happened on channel(x) of I-7532, the CH(x) ERR LED will be always ON until the bus-off condition is solved.

2.4 Reset & Error Clear Button

Table 2-2: Reset & Error Clear Button

Reset & Error Clear Button	
Click once	Clear Error LED
Press Over 3 sec	Module Reset

[Note]

1. Users can press this button once to clear the “buffer overflow“ Error LED status, but it can not be used to clear the “transmission fail” or bus-off” error LED status.
2. If users want to reset I-7532, just press “RST & Error Clear” button over 3 sec, then all LEDs of I-7532 will flash once and reset. After that, the PWR LED will be on and other LEDs will be off.

2.5 CANBaud Rotary Switch

Users can use the “CANBaud Rotary Switch” to change the CAN1 and CAN2 baud of I-7532 and it supports 15 kinds of baud shown on Table 2-3. After changing the rotary switch value, users need to reset I-7532 to take the setting effect. If the “CANBaud Rotary Switch” is set to be ‘0’, then I-7532 will go into module configuration mode and others of “CANBaud Rotary Switch” will go into communication mode.

Table 2-3: Rotary Switch Value & Baud

Switch Value	0	1	2	3	4	5	6	7
Baud [bps]	Config Mode	5k or user-defined CAN baud	10k	20k	40k	50k	80k	100k

Switch Value	8	9	A	B	C	D	E	F
Baud [bps]	125k	200k	250k	400k	500k	600k	800k	1M

2.5.1 BootLoader Mode

If users set rotary switch of CAN1 and CAN2 to be ‘0’ position simultaneously and reboot I-7532, then I-7532 will go into bootloader mode for “Firmware Update” via CAN bus (Just for **CAN1 of I-7532 with Baud equals 1000Kbps**). The bootloader function is provided for firmware version 1.02 or newer.

In bootloader mode, the PWR LED will flash per second continuously and users can use “FW_Update_CAN” tool like the below figure for firmware update of I-7532. “FW_Update_CAN” tool can be downloaded from the ICP DAS web site :

ftp://ftp.icpdas.com.tw/pub/cd/fieldbus_cd/can/converter/i-7532/software/tool/

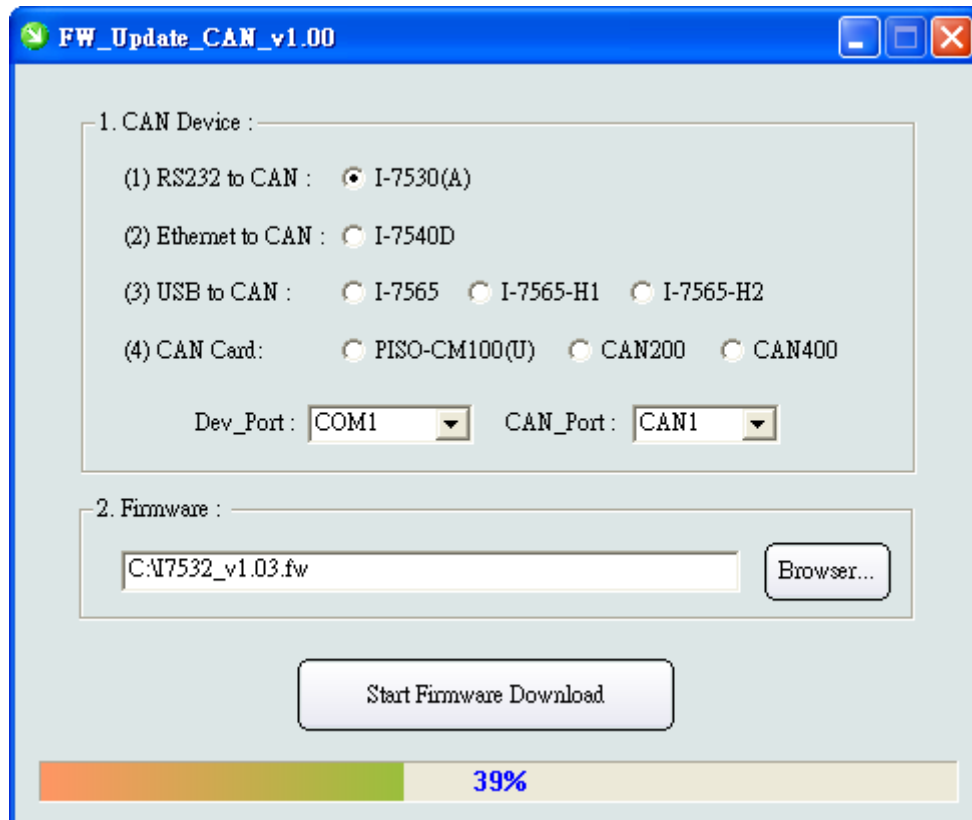

(Firmware Update Utility of I-7532)

Please follow the steps to accomplish the firmware update function of I-7532.

- (1) Choose the CAN interface device. (Current just ICP DAS CAN devices are supported)
- (2) Click the “Browser...” button to choose the I-7532 firmware file like **I7532_v1.03.fw**.
- (3) Click “Start Firmware Download” button to start the firmware update process.

2.5.2 Communication Mode

If users set rotary switch of CAN1 and CAN2 to be one of ‘1’ to ‘F’ and reboot I-7532, then I-7532 will go into communication mode for CAN message transmission with the assigned CAN baud.

In comm. mode, the PWR LED will be always on and other LEDs will be off initially.

[Note]

There are two kinds of CAN baud recorded in '1' position of "CANBaud Rotary switch". If users had set the user-defined CAN baud before, then it will use user-defined CAN baud recorded in I-7532 for communication. If not, then it will use 5Kbps (default value) for communication. Users can get the user-defined CAN baud by using configuration command.

2.5.3 Configuration Mode

If users set rotary switch of CAN1 or CAN2 to be '0' and reboot I-7532, then I-7532 will go into module configuration mode and users can set the "CAN-ID Filter", "user-defined CANBaud" or "get module information" etc. functions.

In config mode, the PWR LED will flash per 100ms continuously.

(1) If the CH1 Baud rotary switch is set in '0':

[1] The CH1 Rx LED will be always on.

[2] It means that users will be able to config I-7532 via CAN1 of I-7532 with **250Kbps baudrate**.

(2) If the CH2 Baud rotary switch is set in '0':

[1] The CH2 Rx LED will be always on.

[2] It means that users will be able to config I-7532 via CAN2 of I-7532 with 250Kbps baudrate.

The configuration command code consists of CAN-ID and the following is the total commands provided in config mode of I-7532.

Table 2-4: Command Code of Configuration

Function	SendCmd Code (In CAN-ID field)	Response Code (In CAN-ID field)
System Function	0x001 (Get FW_Ver)	0x401
	0x002 (Reset Module)	0x402
		0x4FF (Cmd Fail)

CAN1 Function	0x101 (Start CAN-ID Filter Setting)	0x501
	0x102 (Stop CAN-ID Filter Setting)	0x502
	0x103 (Get CAN-ID Filter Setting)	0x503
	0x104 (Set CAN-ID Filter All Pass)	0x504
	0x105 (Set user-defined CANbaud)	0x505
	0x106 (Get user-defined CANbaud)	0x506
	0x107 (Start CAN-ID Map Setting)	0x507
	0x108 (Stop CAN-ID Map Setting)	0x508
	0x109 (Get CAN-ID Map Setting)	0x509
	0x10A (Set CAN-ID No Map)	0x50A
	0x111 (Set Single 11-bit ID)	0x511
	0x112 (Set Group 11-bit ID)	0x512
	0x113 (Set Single 29-bit ID)	0x513
	0x114 (Set Group 29-bit ID)	0x514
	0x115 (Set Mapping 11-bit ID)	0x515
0x116 (Set Mapping 29-bit ID)	0x516	
	0x5FF (Cmd Fail)	
CAN2 Function	0x201 (Start CAN-ID Filter Setting)	0x601
	0x202 (Stop CAN-ID Filter Setting)	0x602
	0x203 (Get CAN-ID Filter Setting)	0x603
	0x204 (Set CAN-ID Filter All Pass)	0x604
	0x205 (Set user-defined CANbaud)	0x605
	0x206 (Get user-defined CANbaud)	0x606
	0x207 (Start CAN-ID Map Setting)	0x607
	0x208 (Stop CAN-ID Map Setting)	0x608
	0x209 (Get CAN-ID Map Setting)	0x609
	0x20A (Set CAN-ID No Map)	0x60A
	0x211 (Set Single 11-bit ID)	0x611
	0x212 (Set Group 11-bit ID)	0x612
	0x213 (Set Single 29-bit ID)	0x613
	0x214 (Set Group 29-bit ID)	0x614
	0x115 (Set Mapping 11-bit ID)	0x615
0x116 (Set Mapping 29-bit ID)	0x616	
	0x6FF (Cmd Fail)	

Before starting the configuration of I-7532, there are some rules must be followed.

- (1) The **CAN baud** must be set in **250Kbps** in users' CAN tool.
- (2) The **data length** of SendCmd must be **8**. If users just want to set one CAN-ID filter, then just fill "0xFFFFFFFF" in another DW field.
- (3) The "**Mode**" bit of SendCmd is **no limit**.
- (4) The "**RTR**" bit of SendCmd must be **0**.
- (5) In group CAN-ID filter setting, the low CAN-ID needs to place in low-DW field and the high CAN-ID needs to place in Hi-DW field. Or it will return error code 2.
- (6) The CAN-ID value of ResCmd equals the one of SendCmd plus 0x400. The result of SendCmd will be placed in a return code and shown as below :

ResCmd RetCode	Meaning
0x00	No Error
0x01	Process Error
0x02	Parameter Format Error
0x03	CAN-ID Filter Record Error
0x04	Command No. Error
0x05	CAN No. Error
0x06	Command Length Error
0x07	RTR Error

There are two methods for configuration of I-7532 and described as chapter 2.5.4 and 2.5.5.

2.5.4 Configuration via I-7532 Utility

The "I-7532 Utility" is provided by ICP DAS to configure I-7532 module easily and quickly and can be downloaded from the ICP

DAS web site :

ftp://ftp.icpdas.com.tw/pub/cd/fieldbus_cd/can/converter/i-7532/software/utility/. The following is operation description of I-7532 utility.

[Step 1 – Setting before I-7532 Configuration]

1. Setting via “I-7530” module:

[1] Set the following parameters by using I-7530 utility.

- (1) Set COM_Baud=**115200**; DataBit=**8**; StopBit=**1**;
Parity=**None**; CheckSum=**No.**; Error Response=**No**
- (2) Set CAN Spec.=**2.0B**; CAN Baud=**250Kbps**
- (3) Set CAN Acceptance Code and Mask= **00000000**
- (4) **Disable** “Pair Connection” function.

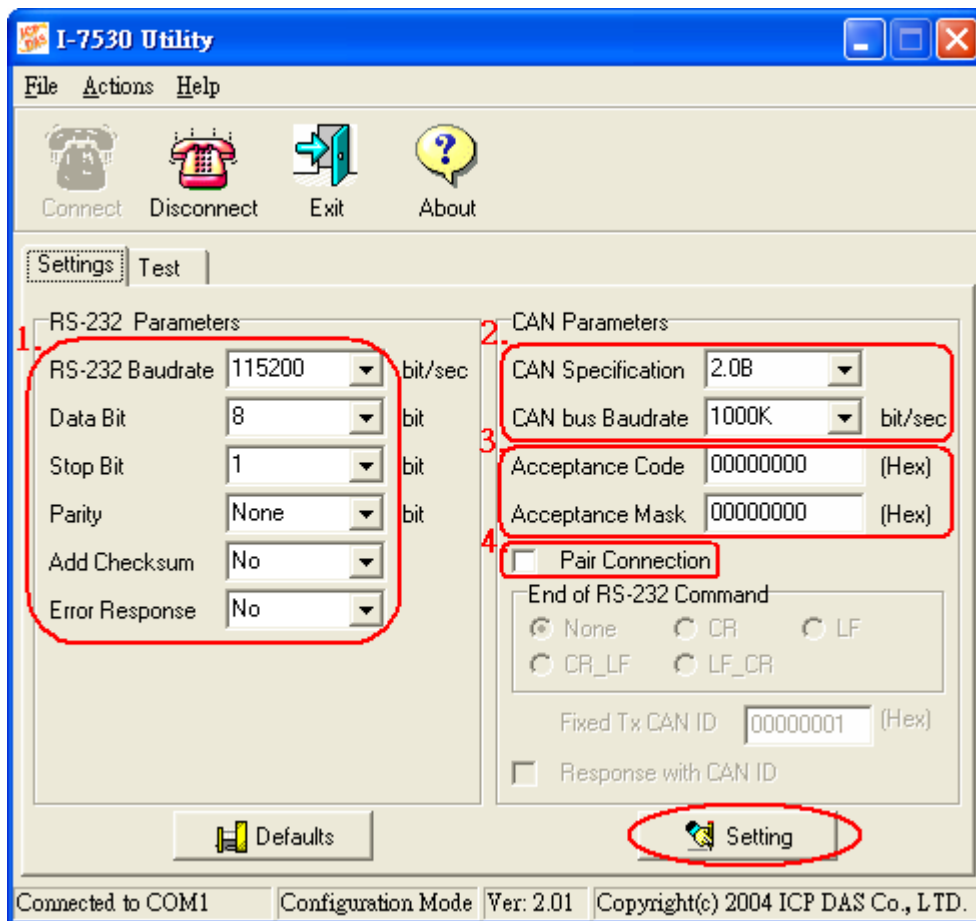

(I-7530 Utility)

2. Setting via “I-7540D” module:

[1] Install “VxComm_Driver” and run “VxComm Utility” :

- (1) Click “Search Servers” button
- (2) Click “Add Server(s)” button

- (3) Set "Port 3" of I-7540D to be a **Virtual COM**. (like COM20)
- (4) Execute "**Restart Driver**"

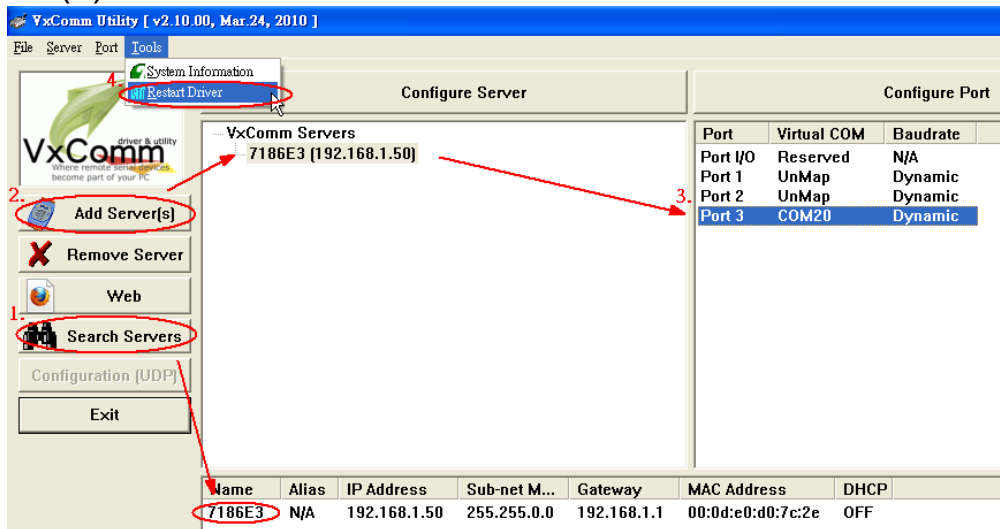

(VxComm Utility)

[2] Set the following parameter by using I-7540D Utility.

- (1) Set CAN Spec.=**2.0B**; CAN Baud=**250K**bps
- (2) Set Acceptance Code=**00000000**; Mask= **FFFFFFFF**
- (3) Set Error Resp.= **No**; TimeStamp Resp.= **No**
- (4) **Disable** "Pair Connection" function.

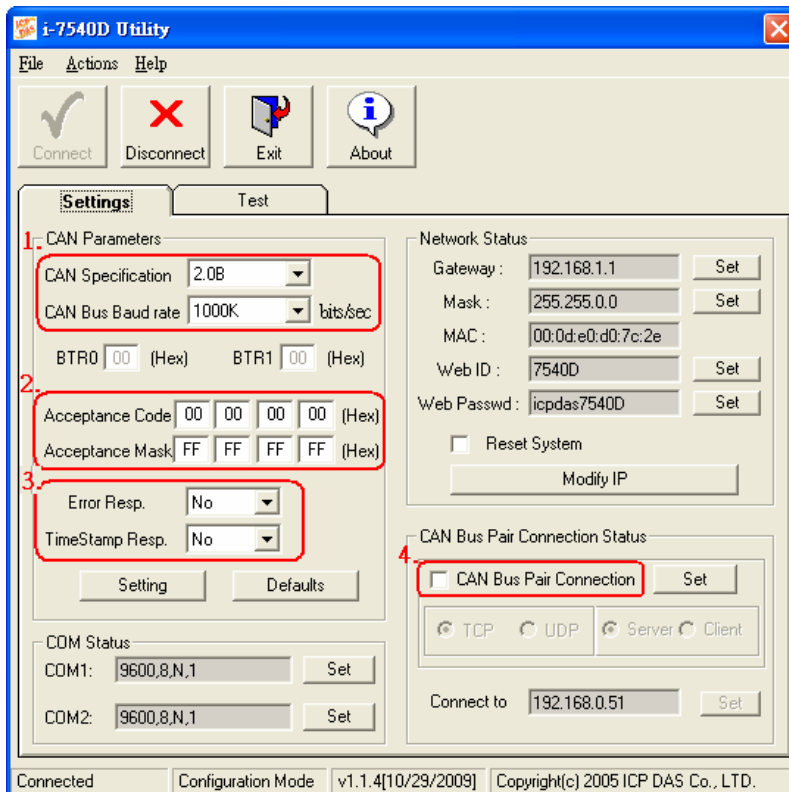

(I-7540D Utility)

Setting via “I-7565” module:

[1] Set the following parameter by using I-7565 utility.

- (1) Set CheckSum=**No.**; Error Response=**No**
- (2) Set CAN Spec.=**2.0B**; Baud=**250Kbps**.
- (3) Set CAN Acceptance Code and Mask= **00000000**.

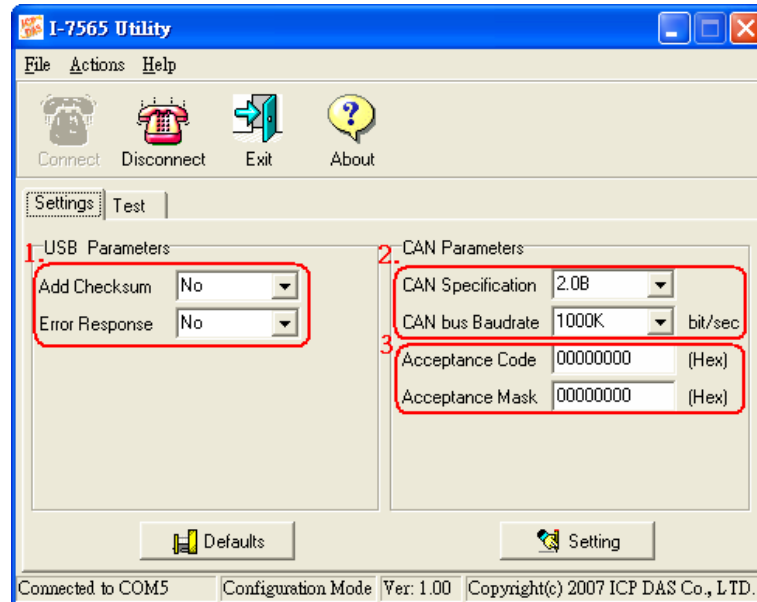

(I-7565 Utility)

[Step 2 – I-7532 Utility Configuration]

[1] CAN Device :

The below ICP DAS CAN products are supported by I-7532 utility for configuration.

- (1) RS232 to CAN : I-7530
- (2) Ethernet to CAN: I-7540D
- (3) USB to CAN : I-7565, I-7565-H1, I-7565-H2
- (4) CAN Card : PISO-CM100(U),
PISO-/PCM-/PEX-CAN200 / CAN400

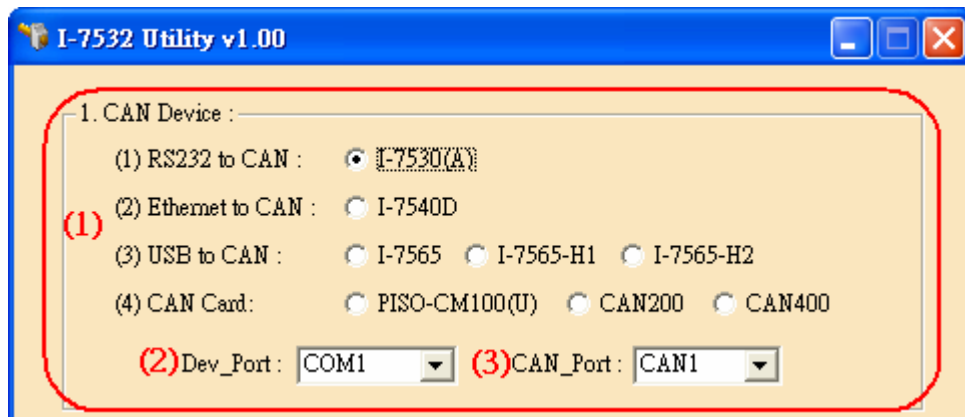

ICP DAS CAN Device Setting

Before configuration of I-7532, users need to set the below parameters.

- (1) CAN hardware interface
- (2) Dev_Port / Board_ID
- (3) CAN_Port” number

[2] CAN-ID Filter / Mapping Setting :

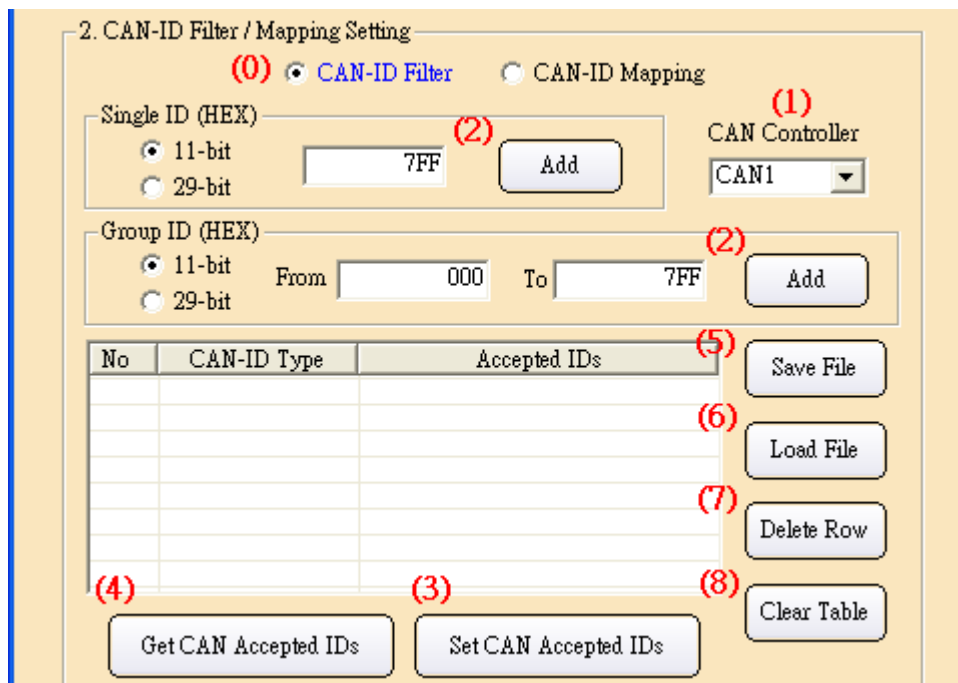

CAN-ID Filter Setting

(0) “CAN-ID Filter / Mapping Function” :

It is used to choose CAN-ID Filter or CAN-ID Mapping configuration function of I-7532.

(1) **“CAN Controller”** :

It is used to choose which CAN port (CAN1 or CAN2) of I-7532 for CAN-ID filter setting.

(2) **“Add”** button :

[1] **“CAN-ID Filter”** Option:

It is used to add “11-bit Single-ID”, “29-bit Single-ID”, “11-bit Group-ID”, “29-bit Group-ID” to CAN-ID filter table.

[2] **“CAN-ID Mapping”** Option:

<1> It is used to add 11-bit Mapping-ID”, “29-bit Mapping-ID” to CAN-ID mapping table.

<2> The below CAN-ID mapping function has already supported in **FW_v1.04** and **Utility_v1.03**.

	11-bit (Transfer CAN-ID)	29-bit (Transfer CAN-ID)
11-bit (Recv CAN-ID)	OK	OK
29-bit (Recv CAN-ID)	OK	OK

2. CAN-ID Filter / Mapping Setting

CAN-ID Filter CAN-ID Mapping

Single ID (HEX)

11-bit 29-bit

7FF Add

CAN Controller: CAN1

Mapping ID (HEX)

11-bit 29-bit

23 To 11-bit 29-bit

23 Add

No	CAN-ID Type	Mapping IDs
001	11>11-bit MID	0x011>0x223
002	11>29-bit MID	0x236>0x00006598
003	29>11-bit MID	0x000AB123>0x1AB
004	29>29-bit MID	0x000AABBC>0x0FEDCA11
005	11>11-bit MID	0x710>0x601
006	11>11-bit MID	0x711>0x555
007	11>29-bit MID	0x005>0x00000005
008	29>11-bit MID	0x00000023>0x023

Save File Load File Delete Row Clear Table

Get CAN Mapping IDs Set CAN Mapping IDs

(3) **“Set CAN Accepted / Mapping IDs”** button :

It is used to set CAN-ID filter / mapping data in CAN-ID filter / mapping table to I-7532 and users need to choose “CAN Controller” number first. After clicking the button, it will show the total percentage in the progress bar. If the table is blank,

then it will set all CAN-IDs without filter or mapping function.



Total Percentage of CAN-ID Filter Setting

(4) **“Get CAN Accepted / Mapping IDs”** button :

It is used to get CAN-ID filter / mapping data from I-7532 and users need to choose “CAN Controller” number first. Then CAN-ID filter / mapping data will be shown in CAN-ID filter / mapping table. If the result in the table is blank, it means that the CAN-ID filter or mapping function is not used in the CAN port.

(5) **“Save File”** button :

It is used to save CAN-ID filter / mapping data in CAN-ID filter / mapping table to file. There are two file format for file saving.

[1] **“*.dat”** format :

It is used to save CAN-ID filter / mapping data to file (.dat) in binary format. The file format is compatible with configuration file of I-7565-H1 and I-7565-H2.

[2] **“*.xls”** format :

It is used to save CAN-ID filter / mapping data to file (.xls) in CAN message format and useful for CAN hardware interface of other companies to configure CAN-ID filter / mapping function of I-7532.

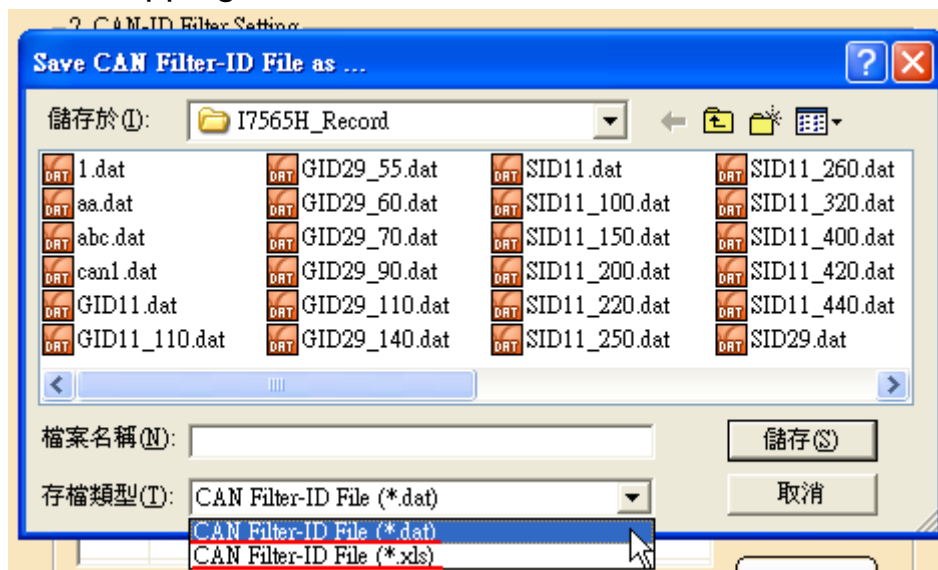

File format of “Save File” Function

(6) **“Load File”** button :

It is used to load CAN-ID filter / mapping data from file (*.dat) to CAN-ID filter / mapping table.

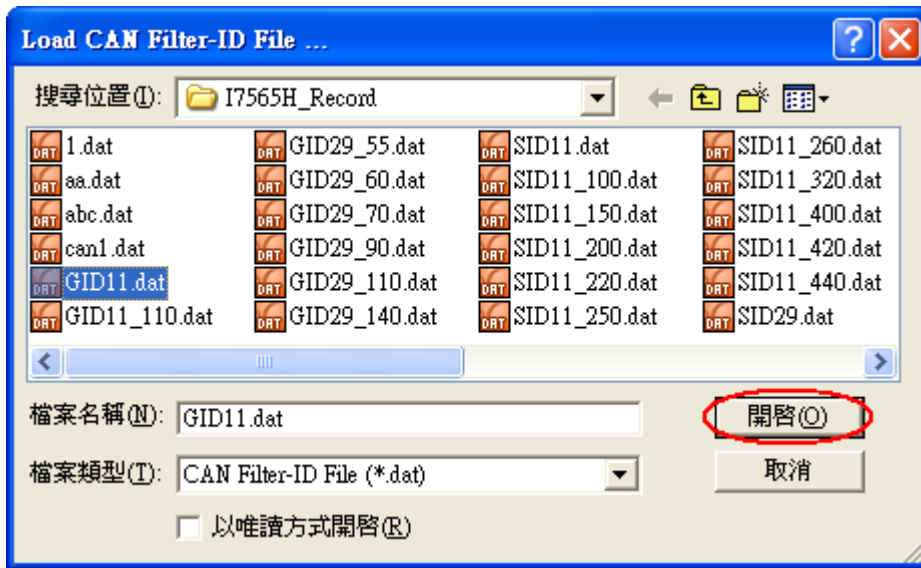

“Load File” Function

- (7) **“Delete Row”** button :
It is used to delete one row chosen in CAN-ID filter / mapping table.
- (8) **“Clear Table”** button :
It is used to clear all data in CAN-ID filter / mapping table.

[3] Config / Info Option : (For I-7532 Utility v1.02)

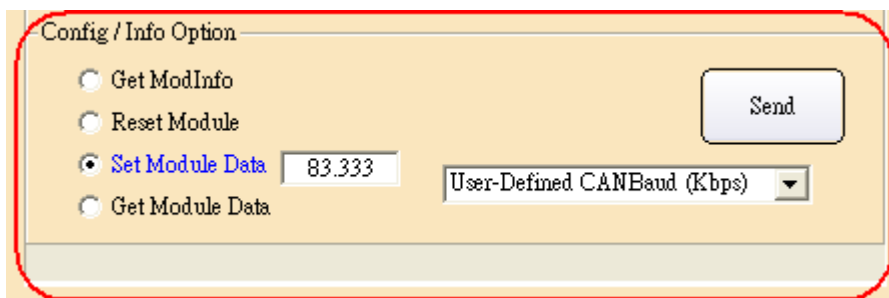

- (1) **“Get ModInfo”** :
It is used to get module information of I-7532, for example: firmware version.



Module Information

(2) **“Reset Module”** :

It is used to reset I-7532 module. (Just for I-7532 in configuration mode)

(3) **“Set User-Defined CANBaud (Kbps)”** :

It is used to set user-defined CAN baudrate to I-7532 by filling value in the right field and users need to choose “CAN Controller” number first.

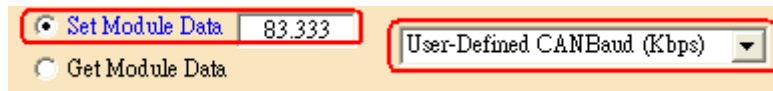

Set User-Defined CANBaud

(4) **“Get User-Defined CANBaud”** :

It is used to get user-defined CAN baudrate from I-7532 and users need to choose “CAN Controller” number first.

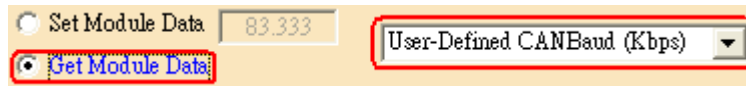

Get CAN1 User-Defined Baudrate

(5) **“Set CAN Bus-Off Auto-Reset Time (Sec)”** :

It is used to set CAN Bus-Off Auto-Reset Time to I-7532 by filling value in the right field.

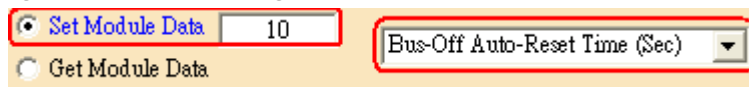

Set CAN Bus-Off Auto-Reset Time

(6) **“Get CAN Bus-Off Auto-Reset Time (Sec)”** :

It is used to get CAN Bus-Off Auto-Reset Time from I-7532.

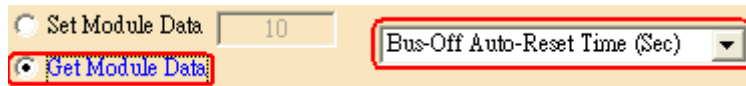

Get CAN Bus-Off Auto-Reset Time

=> If the value of the “CAN Bus-Off Auto-Reset Time” is zero, it means that the function is disabled. If not, I-7532 will be reset automatically when CAN Bus-Off happened with continuous 10 seconds for the above example.

(7) “Set CAN Listen-Only Mode” :

It is used to set CAN1 or CAN2 channel in I-7532 to be Listen-Only mode. In this mode, the CAN channel in I-7532 will not ack the CAN message.

[1] Set “1” => Enable Listen-Only Mode.

[2] Set “0” => Disable Listen-Only Mode.

2. CAN-ID Filter / Mapping Setting

CAN-ID Filter CAN-ID Mapping

Single ID (HEX)

11-bit 29-bit

7FF Add

CAN Controller
CAN1

Group ID (HEX)

11-bit 29-bit

From 000 To 7FF Add

No	CAN-ID Type	Accepted IDs

Save File
Load File
Delete Row
Clear Table

Get CAN Accepted IDs Set CAN Accepted IDs

Config / Info Option

Get ModInfo Reset Module Send

Set Module Data 1 CAN Listen-Only Mode

Get Module Data

Set CAN Listen-Only Mode

(8) “Get CAN Listen-Only Mode” :

It is used to get the Listen-Only mode state of CAN1 or CAN2 in I-7532.

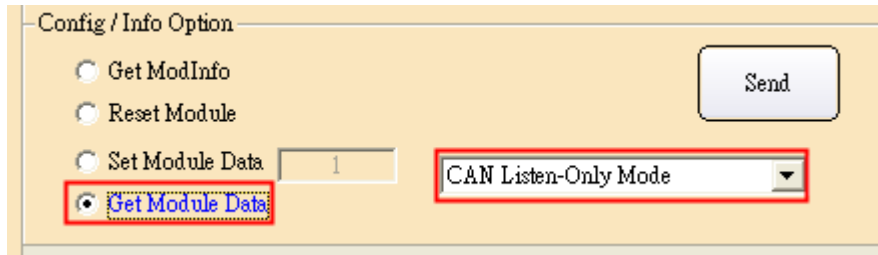

Get CAN Listen-Only Mode

If the “**Config Command Timeout**” error message shows up when configure I-7532, please check the following status.

- (1) Check “CAN bus hardware connection”.
- (2) Check “Communication Parameter of CAN device”.
- (3) Check I-7532 module if it is in “Configuration” mode.

2.5.5 Configuration via Sending Config Command

If users don't have ICP DAS CAN hardware supported in I-7532 Utility, then users need to send CAN message by following the configuration command format of I-7532. The following is the detailed description and demo for configuration functions of I-7532 and I-7565-H2 module (USB2CAN) is applied for the following demo.

[1] System Functions :

(1) 0x001 (Get FW_Ver) :

SendMsg Configuration														
Mode	ID (Hex)	RTR	DLC	D1	D2	D3	D4	D5	D6	D7	D8	Timer (ms)		
11-bit ID	001	No	8	00	00	00	00	00	00	00	00	0		
No.	MODE	ID(hex)	RTR	DLC	D1	D2	D3	D4	D5	D6	D7	D8	Timer	Status
1	0	001	0	8	00	00	00	00	00	00	00	0		
2														

SendCmd

CAN2 RecvMsg													<input checked="" type="checkbox"/> Scrolling	
No	MODE	ID(hex)	RTR	DLC	D1	D2	D3	D4	D5	D6	D7	D8	TimeStamp(sec)	
1	0	401	0	2	01	01							5225.3961	

Low Byte High Byte

ResCmd

[1] SendCmd :

Type "001" in ID field and "8" in DLC field and then send it out.

[2] ResCmd :

(1) "401" in ID field is the response CAN-ID for SendCmd – 0x001 (0x001+0x400 = 0x401).

(2) "02" in DLC field means response data length.

(3) "01" in D2 (High Byte – Integer part of FW_Ver)

"01" in D1 (Low Byte – Decimal part of FW_Ve)

=> the version of firmware is v1.01.

(2) 0x002 (Reset Module) :

SendMsg Configuration													
Mode	ID (Hex)	RTR	DLC	D1	D2	D3	D4	D5	D6	D7	D8	Timer (ms)	
11-bit ID	002	No	8	00	00	00	00	00	00	00	00	0	

No.	MODE	ID(hex)	RTR	DLC	D1	D2	D3	D4	D5	D6	D7	D8	Timer	Status
1	0	002	0	8	00	00	00	00	00	00	00	00	0	
2														

SendCmd

CAN2 RecvMsg													<input checked="" type="checkbox"/> Scrolling	
No	MODE	ID(hex)	RTR	DLC	D1	D2	D3	D4	D5	D6	D7	D8	TimeStamp(sec)	
1	0	402	0	1	00								4248.9700	

Return Code

ResCmd

[1] ResCmd :

If there is no any data to return, then it will just return the result of SendCmd with the return code.

(3) 0x003 (Set CAN Bus-Off Auto-Reset Time) :

Mode	ID (Hex)	RTR	DLC	D1	D2	D3	D4	D5	D6	D7	D8	Timer (ms)
11-bit ID	003	No	8	0A	00	00	00	00	00	00	00	0

No.	MODE	ID(hex)	RTR	DLC	D1	D2	D3	D4	D5	D6	D7	D8	Timer	Status
1	0	003	0	8	0A	00	00	00	00	00	00	00	0	
2														

SendCmd

CAN1 RecvMsg													
<input checked="" type="radio"/> Scroll Mode <input type="radio"/> OverWrite Mode										<input checked="" type="checkbox"/> Scrolling			
No	MODE	ID(hex)	RTR	DLC	D1	D2	D3	D4	D5	D6	D7	D8	TimeStamp(sec)
1	0	403	0	1	00								214025.2887

ResCmd

[1] SendCmd :

Type "003" in ID field and "8" in DLC field.
 "00" in D2 (High Byte of Auto Reset Time)
 "0A" in D1 (Low Byte of Auto Reset Time)
 => It means that the auto reset time is 10 seconds.
 Then send it out.

[2] ResCmd :

- (1) "403" in ID field is the response CAN-ID.
- (2) "01" in DLC field means response data length.
- (3) "00" in D1 is the return code for SendCmd.

(4) 0x004 (Get CAN Bus-Off Auto-Reset Time) :

Mode	ID (Hex)	RTR	DLC	D1	D2	D3	D4	D5	D6	D7	D8	Timer (ms)
11-bit ID	004	No	8	00	00	00	00	00	00	00	00	0

No.	MODE	ID(hex)	RTR	DLC	D1	D2	D3	D4	D5	D6	D7	D8	Timer	Status
1	0	004	0	8	00	00	00	00	00	00	00	00	0	
2														

SendCmd

CAN1 RecvMsg													
<input checked="" type="radio"/> Scroll Mode <input type="radio"/> OverWrite Mode										<input checked="" type="checkbox"/> Scrolling			
No	MODE	ID(hex)	RTR	DLC	D1	D2	D3	D4	D5	D6	D7	D8	TimeStamp(sec)
1	0	404	0	2	0A	00							214025.2887

ResCmd

[1] SendCmd :

Type "004" in ID field and "8" in DLC field and then send it out.

[2] ResCmd :

- (1) "404" in ID field is the response CAN-ID.
- (2) "02" in DLC field means response data length.
- (3) "00" in D2 (High Byte of Auto Reset Time)
 "0A" in D1 (Low Byte of Auto Reset Time)
 => the auto reset time is 10 seconds.

[2] CAN1 Functions :

[CAN-ID Filter]

(1) 0x101 (Start CAN-ID Filter Setting) :

(2) 0x111 / 0x112 / 0x113 / 0x114 (Set CAN-ID Filter data) :

(3) 0x102 (Stop CAN-ID Filter Setting) :

For example :

There are four CAN-ID types in I-7532.

(1) Single 11-bit CAN-ID: 0x001, 0x010

(2) Group 11-bit CAN-ID: 0x100 ~ 0x706

(3) Single 29-bit CAN-ID: 0x1F000201

(4) Group 29-bit CAN-ID: 0x01000000 ~ 0x1F000000

If users just want to receive the above CAN-IDs (White List), please refer to the below demo.

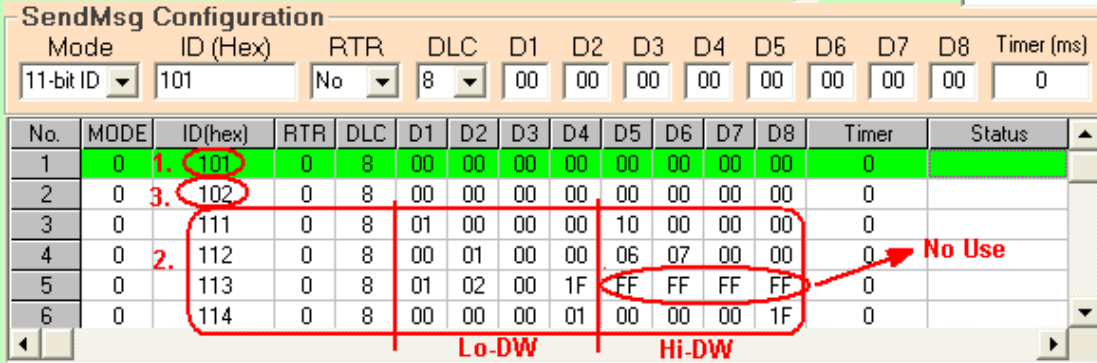

The screenshot shows the 'SendMsg Configuration' dialog box. At the top, there are fields for Mode (11-bit ID), ID (Hex) (101), RTR (No), DLC (8), and D1-D8 (all 00), and a Timer (ms) field (0). Below this is a table with columns: No., MODE, ID(hex), RTR, DLC, D1, D2, D3, D4, D5, D6, D7, D8, Timer, and Status. The table contains 6 rows of data. Row 1: MODE 0, ID 101, RTR 0, DLC 8, D1-D8 00, Timer 0. Row 2: MODE 0, ID 102, RTR 0, DLC 8, D1-D8 00, Timer 0. Row 3: MODE 0, ID 111, RTR 0, DLC 8, D1 01, D2 00, D3 00, D4 00, D5 10, D6 00, D7 00, D8 00, Timer 0. Row 4: MODE 0, ID 112, RTR 0, DLC 8, D1 00, D2 01, D3 00, D4 00, D5 06, D6 07, D7 00, D8 00, Timer 0. Row 5: MODE 0, ID 113, RTR 0, DLC 8, D1 01, D2 02, D3 00, D4 1F, D5 FF, D6 FF, D7 FF, D8 FF, Timer 0. Row 6: MODE 0, ID 114, RTR 0, DLC 8, D1 00, D2 00, D3 00, D4 01, D5 00, D6 00, D7 00, D8 1F, Timer 0. Red circles and lines highlight the IDs 101, 102, 111, 112, 113, 114 and the DW values for 111-114. A red arrow points to the 'No Use' text next to row 4. The labels 'Lo-DW' and 'Hi-DW' are placed below the D1-D4 and D5-D8 columns respectively.

No.	MODE	ID(hex)	RTR	DLC	D1	D2	D3	D4	D5	D6	D7	D8	Timer	Status
1	0	101	0	8	00	00	00	00	00	00	00	00	0	
2	0	102	0	8	00	00	00	00	00	00	00	00	0	
3	0	111	0	8	01	00	00	00	10	00	00	00	0	
4	0	112	0	8	00	01	00	00	06	07	00	00	0	No Use
5	0	113	0	8	01	02	00	1F	FF	FF	FF	FF	0	
6	0	114	0	8	00	00	00	01	00	00	00	1F	0	

SendCmd

[1] SendCmd:

- (1) Send ID – “0x101” to start CAN-ID filter setting.
- (2) Send ID – “0x111” ~ “0x114” for CAN-ID filter data.
- (3) Send ID – “0x102” to stop CAN-ID filter setting.

[Note]

- (1) Lo-DW value and Hi-DW value are two CAN-ID filter data.
- (2) DW value - “0xFFFFFFFF” means the DW value is no use.
- (3) When setting group CAN-ID filter function, the Lo-DW value must be smaller than the Hi-DW value.

CAN2 RecvMsg													<input checked="" type="checkbox"/> Scrolling
No	MODE	ID(hex)	RTR	DLC	D1	D2	D3	D4	D5	D6	D7	D8	TimeStamp(sec)
1	0	1. 501	0	1	00								7685.4951
2	0	511	0	8	01	00	00	00	10	00	00	00	7687.0552
3	0	2. 512	0	8	00	01	00	00	06	07	00	00	7688.0552
4	0	513	0	4	01	02	00	1F					7689.5112
5	0	514	0	8	00	00	00	01	00	00	00	1F	7692.5593
6	0	3. 502	0	1	00								7696.0994

ResCmd

[2] ResCmd:

When sending CAN-ID filter data, it will return the result of the received CAN-ID filter data.

[Note]

The total capacity for CAN-ID filter function of each CAN port in I-7532 is **500 WORD**. Table 2-5 describes the size of every different type CAN Filter-ID.

	Size (Unit: WORD)
11-bit Single ID	1
11-bit Group ID	2
29-bit Single ID	2
29-bit Group ID	4

Table 2-5: Size of Every Different Type CAN Filter-ID

According to Table 2-5, Table 2-6 describes the supported CAN Filter-ID number of each CAN port in I-7532.

	I-7532 (Each CAN Port)
11-bit Single ID	500/1 = 500
11-bit Group ID	500/2 = 250
29-bit Single ID	500/2 = 250
29-bit Group ID	500/4 = 125

Table 2-6: Number of every different type CAN ID

[CAN-ID Mapping]

(1.1) [0x107](#) (Start CAN-ID Mapping Setting) :

(2.1) [0x115](#) (Set 11-bit CAN-ID Mapping data) :

[0x116](#) (Set 29-bit CAN-ID Mapping data) :

(3.1) [0x108](#) (Stop CAN-ID Mapping Setting) :

CAN-ID Mapping number of each CAN port in I-7532.

	I-7532 (Each CAN Port)
11-bit Mapping ID	500
29-bit Mapping ID	250

Table 2-6.1: size of every different type CAN ID

[For Example]

Ex1: Set the below CAN-ID Mapping.

(1) 11 bit : 0x101 -> 0x201

(2) 29 bit : 0x1F000101 -> 0x1F000201

2. CAN-ID Filter / Mapping Setting

CAN-ID Filter CAN-ID Mapping

Single ID (HEX)

11-bit 29-bit

7FF Add

CAN Controller: CAN1

Mapping ID (HEX)

11-bit 29-bit

From: 000 To: 7FF Add

No	CAN-ID Type	Mapping IDs
001	11-bit MID	0x101 > 0x201
002	29-bit MID	0x1F000101 > 0x1F000201

Save File Load File Delete Row Clear Table

Get CAN Mapping IDs Set CAN Mapping IDs

Method : (Mode=0, RTR=0, DLC=8 are fixed for the sent CAN msg)

(1) Send the CAN msg with ID=0x107 and D1~D8 are all zero.

=> If succeed, return CAN msg with ID=0x507

- (2) Send the CAN msg with **ID=0x115** and D1=0x01, D2=0x01, D3~D4=0x00, D5=0x01, D6=0x02, D7~D8=0x00
=> If succeed, return CAN msg with ID=0x515
- (3) Send the CAN msg with **ID=0x116** and D1=0x01, D2=0x01, D3=0x00, D4=0x1F, D5=0x01, D6=0x02, D7=0x00, D8=0x1F
=> If succeed, return CAN msg with ID=0x516
- (4) Send the CAN msg with **ID=0x108** and **D1~D8 are all zero.**
=> If succeed, return CAN msg with ID=0x508
=> The detailed CAN message, please refer to the below figure.

SendMsg Configuration

No.	MODE	ID(hex)	RTR	DLC	D1	D2	D3	D4	D5	D6	D7	D8	Timer	Status
1	0	107	0	8	00	00	00	00	00	00	00	00	0	
2	0	108	0	8	00	00	00	00	00	00	00	00	0	
3	0	115	0	8	01	01	00	00	01	02	00	00	0	11to11, 0x101->0x201
4	0	116	0	8	01	01	00	1F	01	02	00	1F	0	29to29, 0x1F00101->0x1F00201

CAN1 RecvMsg

No.	MODE	ID(hex)	RTR	DLC	D1	D2	D3	D4	D5	D6	D7	D8	TimeStamp(sec)
1	0	507	0	1	00								2493.1981
2	0	515	0	8	01	01	00	00	01	02	00	00	2496.7982
3	0	516	0	8	01	01	00	1F	01	02	00	1F	2498.2942
4	0	508	0	1	00								2500.8584

(4) 0x103 (Read CAN-ID Filter Setting) :

SendMsg Configuration

Mode	ID (Hex)	RTR	DLC	D1	D2	D3	D4	D5	D6	D7	D8	Timer (ms)
11-bit ID	103	No	8	00	00	00	00	00	00	00	00	0

No.	MODE	ID(hex)	RTR	DLC	D1	D2	D3	D4	D5	D6	D7	D8	Timer	Status
1	0	103	0	8	00	00	00	00	00	00	00	00	0	
2														
3														

SendCmd

CAN2 RecvMsg Scrolling

No	MODE	ID(hex)	RTR	DLC	D1	D2	D3	D4	D5	D6	D7	D8	TimeStamp(sec)
1	0	503	0	8	01	00	11	00	01	00	00	00	11001.6253
2	0	503	0	8	02	00	11	00	10	00	00	00	11001.6264
3	0	503	0	8	01	00	12	00	00	01	00	00	11001.6275
4	0	503	0	8	01	00	12	00	06	07	00	00	11001.6286
5	0	503	0	8	01	00	13	00	01	02	00	1F	11001.6298
6	0	503	0	8	01	00	14	00	00	00	00	01	11001.6309
7	0	503	0	8	01	00	14	00	00	00	00	1F	11001.6320
8	0	503	0	1	00								11001.6329

ResCmd

[1] ResCmd:

(1) **D1~D2 :**

CAN-ID number of each CAN-ID type. In the demo, it means there are two 11-bit CAN-IDs - 0x001, 0x010, one 11-bit group CAN-ID - 0x100 ~ 0x706, one 29-bit CAN-ID - 0x1F000201, one 29-bit group CAN-ID - 0x01000000 ~ 0x1F000000 passed.

(2) **D3~D4 :**

CAN-ID Type :

0x11 => Single 11-bit ID

0x12 => Group 11-bit ID

0x13 => Single 29-bit ID

0x14 => Group 29-bit ID

(3) **D5~D8 :**

CAN-ID Filter data.

(4.1) 0x109 (Read CAN-ID Mapping Setting) :

SendMsg Configuration

Mode: 11-bit ID, ID (Hex): 109, RTR: No, DLC: 8, D1: 00, D2: 00, D3: 00, D4: 00, D5: 00, D6: 00, D7: 00, D8: 00, Timer (ms): 0

No.	MODE	ID(hex)	RTR	DLC	D1	D2	D3	D4	D5	D6	D7	D8	Timer	Status
1	0	109	0	8	00	00	00	00	00	00	00	00	0	
2														

SendCmd

CAN1 RecvMsg Scrolling

Scroll Mode OverWrite Mode

No	MODE	ID(hex)	RTR	DLC	D1	D2	D3	D4	D5	D6	D7	D8	TimeStamp(sec)
1	0	509	0	8	01	00	15	00	01	01	00	00	281.2359
2	0	509	0	8	01	00	15	00	01	02	00	00	281.2366
3	0	509	0	8	01	00	16	00	01	01	00	1F	281.2372
4	0	509	0	8	01	00	16	00	01	02	00	1F	281.2378
5	0	509	0	1	00								281.2382

ResCmd

[1] ResCmd:

(1) **D1~D2** :

CAN-ID Mapping number of each CAN-ID type. In the demo, it means as below:

[1] one set 11-bit CAN-ID Mapping : 0x101 to 0x201

[2] one 29-bit CAN-ID Mapping 0x1F000101 to 0x1F000201.

(2) **D3~D4** :

CAN-ID Type :

0x15 => 11-bit Mapping-ID

0x16 => 29-bit Mapping-ID

(3) **D5~D8** :

CAN-ID Mapping data.

(5) 0x104 (Set CAN-ID Filter All Pass) :

SendMsg Configuration													
Mode	ID (Hex)	RTR	DLC	D1	D2	D3	D4	D5	D6	D7	D8	Timer (ms)	
11-bit ID	104	No	8	00	00	00	00	00	00	00	00	0	

No.	MODE	ID(hex)	RTR	DLC	D1	D2	D3	D4	D5	D6	D7	D8	Timer	Status
1	0	104	0	8	00	00	00	00	00	00	00	00	0	
2	0	103	0	8	00	00	00	00	00	00	00	00	0	
3														

SendCmd

CAN2 RecvMsg														<input checked="" type="checkbox"/> Scrolling
No	MODE	ID(hex)	RTR	DLC	D1	D2	D3	D4	D5	D6	D7	D8	Time stamp(sec)	
1	0	504	0	1	00								12480.3322	
2	0	503	0	1	00								12638.1013	

ResCmd

After sending the command – 0x104, users can send command – 0x103 to read CAN-ID filter setting again and it will just show command successfully without any filter data.

(5.1) 0x10A (Set CAN-ID without Mapping) :

After sending the command – 0x10A, users can send command – 0x109 to read CAN-ID mapping setting again and it will just show command successfully without any mapping data.

(6) 0x105 (Set user-defined CANbaud) :

For example :

If users want to set user-defined CAN1 baud – **83.333** Kbps, please follow the below steps :

- (1) Get the integer part – 83 and decimal part – 333 of CAN1 baud.
- (2) Transfer decimal mode to hex mode :
83(decimal) -> 0x53(hex), 333(decimal) -> 0x014D(hex)

- (3) **D1~D2 :**

The integer part of user-defined CAN baud.

D3~D4 :

The decimal part of user-defined CAN baud.

Therefore, please type 0x0053 in D1~D2 and 0x014D in D3~D4.

SendMsg Configuration														
Mode	ID (Hex)	RTR	DLC	D1	D2	D3	D4	D5	D6	D7	D8	Timer (ms)		
11-bit ID	105	No	8	53	00	4D	01	00	00	00	00	0		
No.	MODE	ID(hex)	RTR	DLC	D1	D2	D3	D4	D5	D6	D7	D8	Timer	Status
1	0	105	0	8	53	00	4D	01	00	00	00	0		
2														

SendCmd

CAN2 RecvMsg														
No.	MODE	ID(hex)	RTR	DLC	D1	D2	D3	D4	D5	D6	D7	D8	TimeStamp(sec)	
1	0	505	0	1	00								13015.4615	

ResCmd

(7) 0x106 (Read user-defined CANbaud) :

SendMsg Configuration														
Mode	ID (Hex)	RTR	DLC	D1	D2	D3	D4	D5	D6	D7	D8	Timer (ms)		
11-bit ID	106	No	8	00	00	00	00	00	00	00	00	0		
No.	MODE	ID(hex)	RTR	DLC	D1	D2	D3	D4	D5	D6	D7	D8	Timer	Status
1	0	106	0	8	00	00	00	00	00	00	00	0		
2														

SendCmd

CAN2 RecvMsg														
No.	MODE	ID(hex)	RTR	DLC	D1	D2	D3	D4	D5	D6	D7	D8	TimeStamp(sec)	
1	0	506	0	4	53	00	4D	01					5323.4740	
				83				333						

ResCmd

[1] ResCmd:

(1) **D1~D2 :**

This word value is the integer value of user-defined CAN1 baud with Hex format.

(2) **D2~D3 :**

This word value is the decimal value of user-defined CAN1 baud with Hex format.

No	MODE	ID(hex)	RTR	DLC	D1	D2	D3	D4	D5	D6	D7	D8	TimeStamp(sec)
1	0	506	0	1	00								16459.2781

ResCmd

If it just responses return code – 0x00 and means that no user-defined CAN1 baud data is recorded in I-7532.

[3] CAN2 Functions :

The configuration of CAN2 is the same with CAN1 and the only difference is just the **Command Code** (refer to the Table 2-4).

2.6 Pin Assignment

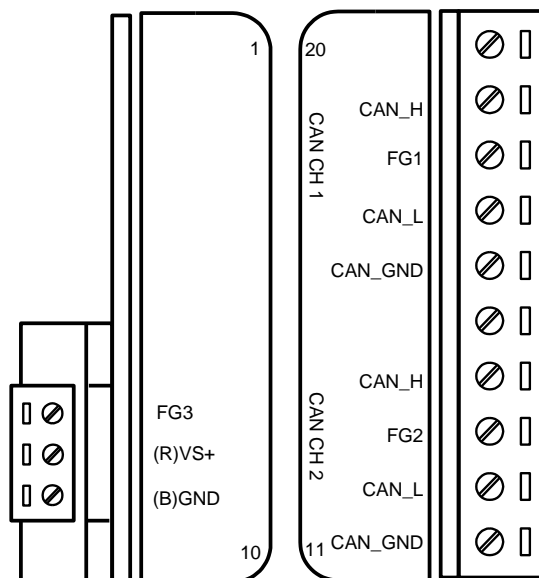

Figure 2-3: CAN & Power Connector of I-7532

Table 2-7: Pin Description of CAN Connector

Part	Name	Description
CAN CH1	CAN_GND	CAN_Ground, ground voltage level of CAN channel 1
	CAN_L	CAN_Low, signal line of CAN channel 1
	FG1	Frame Ground of CAN channel 1
	CAN_H	CAN_High, signal line of CAN channel 1
CAN CH2	CAN_GND	CAN_Ground, ground voltage level of CAN channel 2
	CAN_L	CAN_Low, signal line of CAN channel 2
	FG2	Frame Ground of CAN channel 2
	CAN_H	CAN_High, signal line of CAN channel 2

Table 2-8: Pin Description of Power Connector

Part	Name	Description
Power	(R)VS+	Voltage Source. It could be +10V _{DC} ~ +30V _{DC}
	(B)GND	Power Ground
	FG3	Frame Ground of Power

Note 1: In some cases, the voltage level of CAN_GND of different CAN device in the same CAN bus system are not equal. At this time, it could cause some problems to derogate system stability of this CAN bus system.

There is one way to relieve this situation; user can connect the CAN_GND between those CAN devices to achieve equal voltage level of CAN_GND.

Wiring of CAN_GND is not necessary; user can modify the configuration of wiring according to actual applications.

Note 2: Electronic circuits are constantly vulnerable to Electro-Static Discharge (ESD), which become worse in a continental climate area. FG(Frame Ground) provides a path for bypassing ESD to earth ground, allowing enhanced static protection (ESD) capability and ensures that the module is more reliable.

If user wants to use FG, the FG1 and FG2 and FG3 should be connecting to earth ground. Within the I-7532, FG1 and FG2 and FG3 are not interconnected.



2.7 Wire Connection

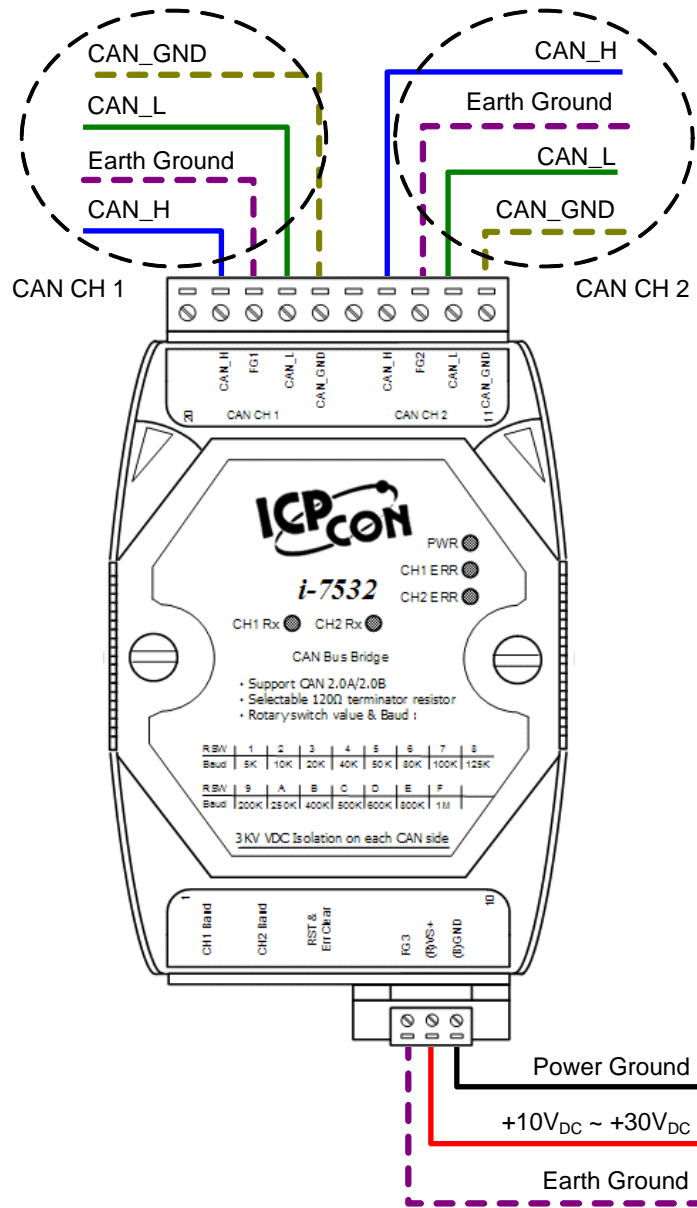

Figure 2-4: Wire Connection of I-7532

2.8 Terminator Resistor Setting

I-7532 includes two built-in 120Ω terminal resistors, users can decide to enable these two terminal resistors or not.

The JP4 of I-7532 is used to adjust terminal resistor on CAN 1, and the JP3 of I-7532 is used to adjust terminal resistor on CAN 2.

Before adjusting JP3 or JP4 of I-7532, users need to open the cover of I-7532 first. The location of JP3 and JP4 is shown as follows:

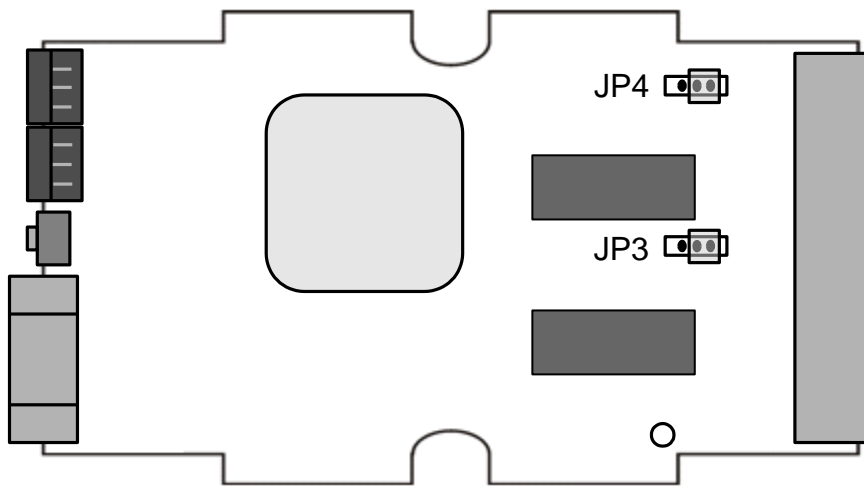

Figure 2-5: JP3 and JP4 positions

The following connection status presents the condition if the terminal resistor is enabled (default) or disabled.

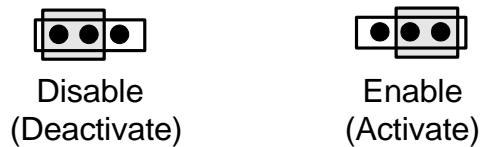

Figure 2-6: Adjustment of Terminator Resistor

3 Network deployment

3.1 Definition

The following figure is the relation among segments in CAN bus and CAN network.

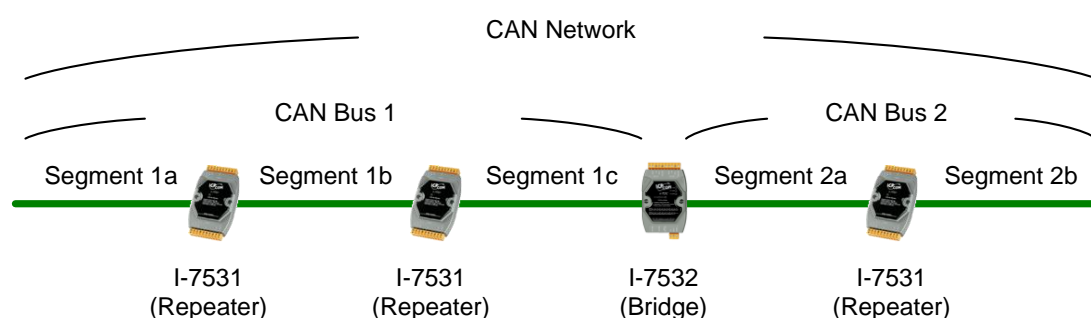

Figure 3-1: Segment, CAN Bus and CAN network

3.2 Cable Selection

The CAN bus following ISO 11898-2 is a balanced (differential) 2-wire interface running over either a Shielded Twisted Pair (STP), Un-shielded Twisted Pair (UTP), or Ribbon cable.

The table below shows the recommended DC parameters of CAN bus line.

Table 3-1: Recommended DC parameters for CAN Bus Line

Wire Cross-Section [mm ²]	Resistance [Ω/km]
~0.25 (AWG23)	< 90
~0.5 (AWG20)	< 50
~0.8 (AWG18)	< 33
~1.3 (AWG16)	< 20

The recommended AC parameters of CAN bus line are 120Ω impedance and 5 ns/m specific line delay.

3.3 Driving Capability

Users can use the following table to know the maximum node number in each segment and the maximum segment length when using different type of wire in the CAN network.

Table 3-2: Driving Capability

Wire Cross-Section [mm ²]	The maximum segment length [m] under the case of specific node number in this segment			
	16 Nodes	32 Nodes	64 Nodes	100 Nodes
~0.25 (AWG23)	<220 m	<200 m	<170 m	<150 m
~0.5 (AWG20)	<390 m	<360 m	<310 m	<270 m
~0.8 (AWG18)	<590 m	<550 m	<470 m	<410 m
~1.3 (AWG16)	<980 m	<900 m	<780 m	<670 m

3.4 Baud and Bus Length

The relationship between ideal bus length and baud in the CAN bus system is displayed below.

Table 3-3: Baud, Bus Length

Baud [bit/sec]	Ideal Bus Length[m]
1M	< 40
800K	< 50
500K	< 100
250K	< 250
125K	< 500
50K	< 1000
20K	< 2500
10K	< 5000

When users want to calculate the bus length, the device used to connect CAN segment must be considered, too. Users can check the specification of the device and find the equivalent bus length of the device. For example, the equivalent bus length of CAN repeater (I-7531) is 40m.

3.5 Terminator Resistor

According to the ISO 11898-2 specifications, the bus line of CAN_H and CAN_L must be terminated by a terminal resistor for proper operation. The equivalent resistance between CAN_H and CAN_L should be 60Ω. There are some examples below.

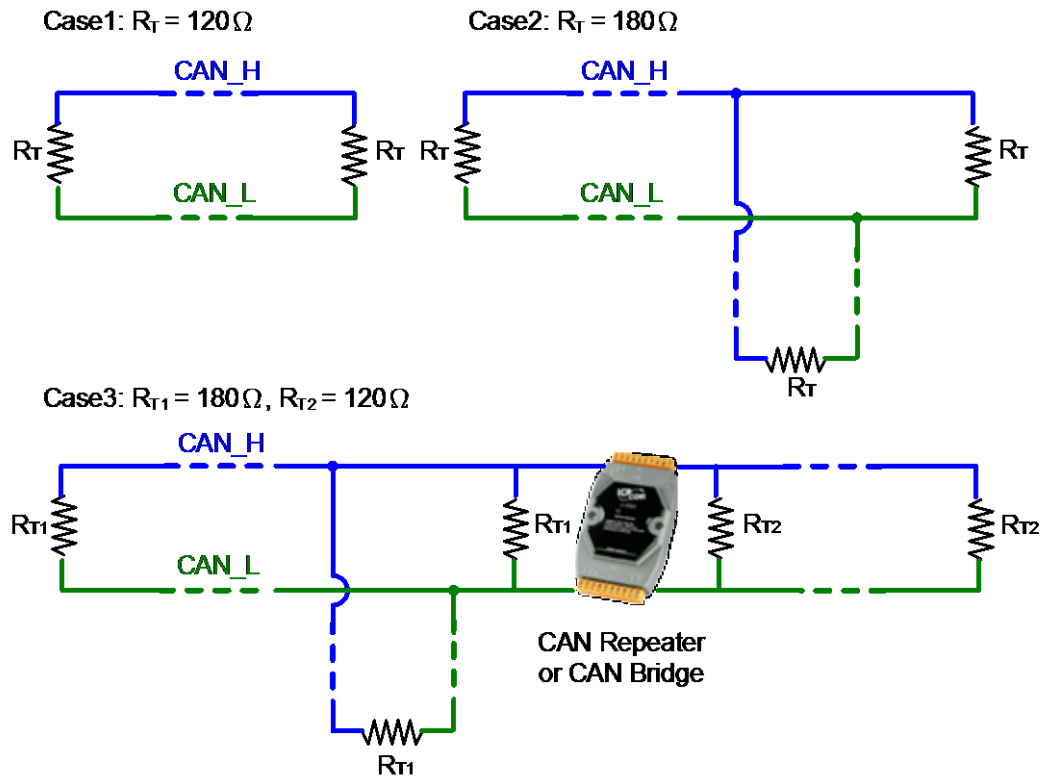

Figure 3-2: Terminator Resistor

4 FAQ

Q01: Firmware update problem in firmware v1.02

In firmware v1.02 of I-7532, the firmware update function is supported. But it exists one bug, so users need to follow the below steps to accomplish the firmware update function of I-7532.

- (1) Open the shell of I-7532.
- (2) Adjust the JP1 position to the left side like Figure 4-1.
- (3) Follow the firmware update standard steps referring to the section 2.5.1 to start the firmware update function.

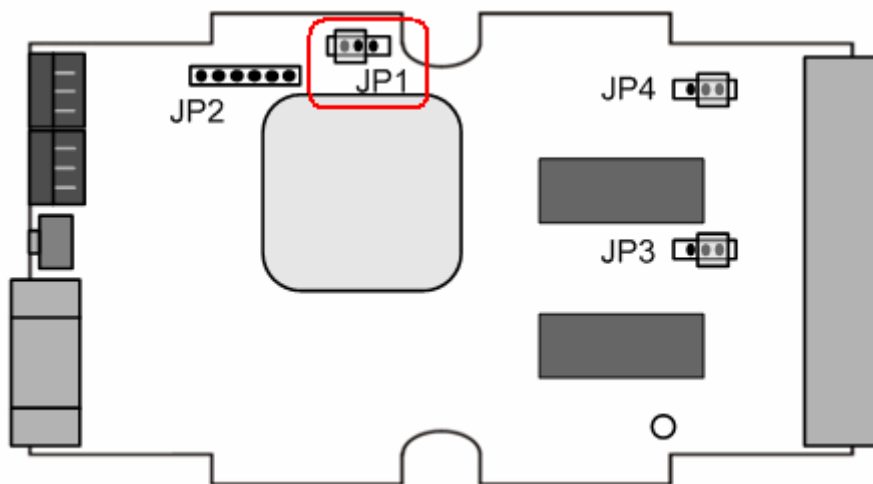

Figure 4-1: JP1 Left Side Position

- (4) After finishing the firmware update process, please adjust the JP1 position back to the right side like Figure 4-2 and reboot I-7532 module.

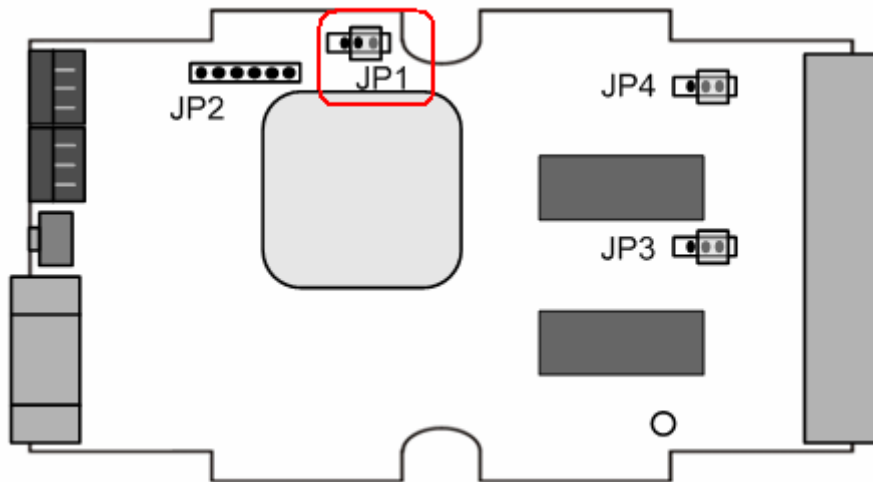

Figure 4-2: JP1 Right Side Position

In firmware v1.03 or newer of I-7532, the problem has been already solved. Users can update firmware directly without opening the shell.

Q02: How to set the CAN-ID Mapping ?

Ans : (2016/06/27)

[Method 1] By using ICP DAS CAN Modules.

Run the I-7532_Utility and follow the below steps.

- [1] Choose "CAN Device".
- [2] Choose "CAN-ID Mapping" option.
- [3] Add the "CAN-ID Mapping" data.
- [4] Choose the CAN channel.
- [5] Click the "Set CAN Mapping IDs" button.

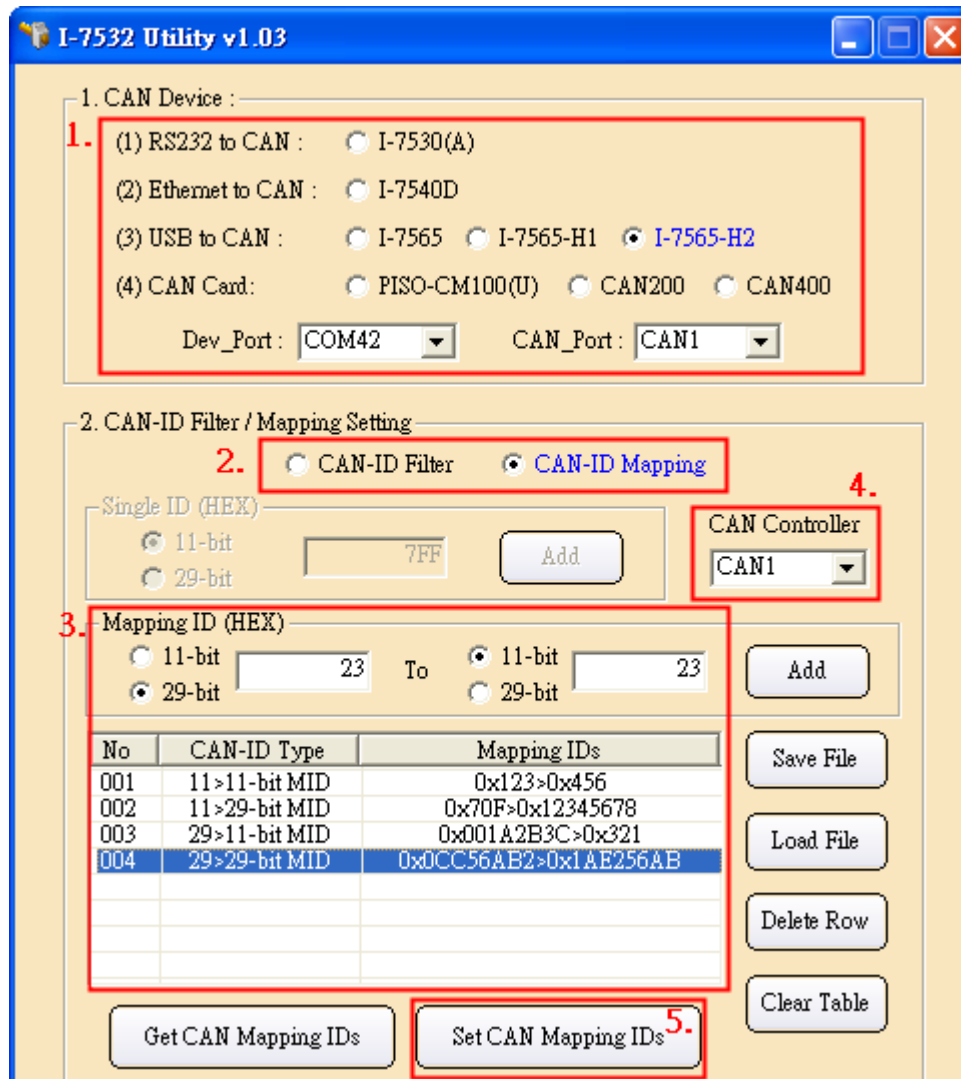

The setting steps of “CAN-ID Mapping”

[Method 2] By using other brand CAN modules.

- [1] Follow the steps from the first to the fourth of method 1.
- [2] Click the “Save File” button to save CAN-ID mapping data to Excel file.

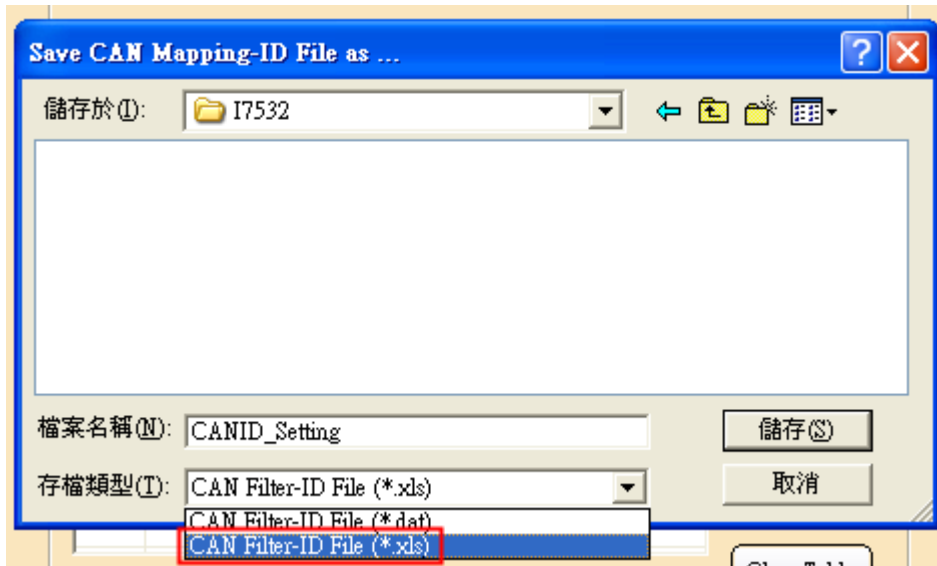

Save CAN-ID Mapping data to Excel

- [3] Open the Excel file of the CAN-ID Mapping file and it will show the CAN messages procedure for setting.

	A	B	C	D	E	F
1	Mode	ID	RTR	DLC	DataL	DataH
2	0	0x107	0	8	0x00000000	0x00000000
3	0	0x115	0	8	0x123	0x456
4	0	0x115	0	8	0x70F	92345678
5	0	0x116	0	8	0x001A2B3C	80000321
6	0	0x116	0	8	0x0CC56AB2	0x1AE256AB
7	0	0x108	0	8	0x00000000	0x00000000

CAN-ID Mapping data in the Excel

No	MODE	ID(hex)	RTR	DLC	D1	D2	D3	D4	D5	D6	D7	D8	TimeStamp(sec)
1	0	107	0	8	00	00	00	00	00	00	00	00	2243.6602
2	0	507	0	1	00								2243.6611
3	0	115	0	8	23	01	00	00	56	04	00	00	2243.7809
4	0	515	0	8	23	01	00	00	56	04	00	00	2243.7820
5	0	115	0	8	0F	07	00	00	78	56	34	92	2243.9686
6	0	515	0	8	0F	07	00	00	78	56	34	92	2243.9697
7	0	116	0	8	3C	2B	1A	00	21	03	00	80	2244.2057
8	0	516	0	8	3C	2B	1A	00	21	03	00	80	2244.2068
9	0	116	0	8	B2	6A	C5	0C	AB	56	E2	1A	2244.4035
10	0	516	0	8	B2	6A	C5	0C	AB	56	E2	1A	2244.4046
11	0	108	0	8	00	00	00	00	00	00	00	00	2244.5937
12	0	508	0	1	00								2244.9990

CAN messages for CAN-ID Mapping setting

Q03: How to set the CAN-ID Filter ?

Ans : (2018/06/13)

[Method 1] By using ICP DAS CAN Modules.

Run the I-7532_Utility and follow the below steps.

- [1] Choose "CAN Device".
- [2] Choose "CAN-ID Filter" option.
- [3] Add the "CAN-ID Filter" data.
- [4] Choose the CAN channel.
- [5] Click the "Set CAN Accepted IDs" button.

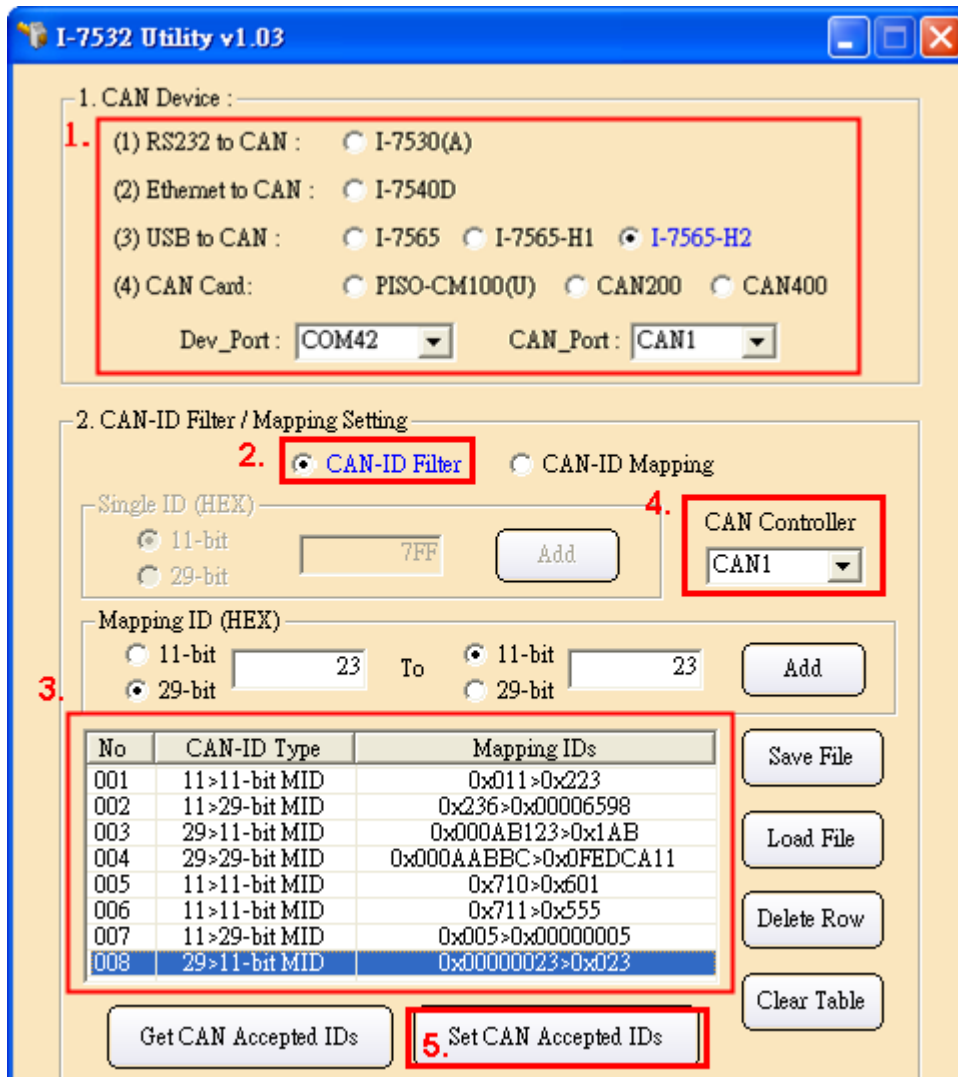

The setting steps of "CAN-ID Filter"

[Method 2] By using other brand CAN modules.

- [1] Follow the [2] and [3] steps of method 1.
- [2] Click the "Save File" button to save CAN-ID filter data to Excel

file.

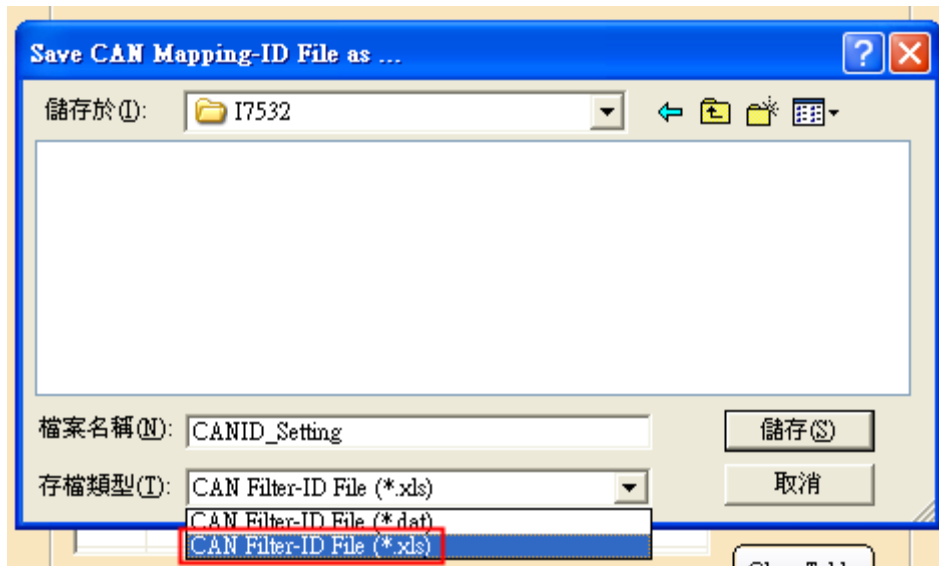

Save “CAN-ID Filter” data to Excel

- [3] Open the Excel file of the “CAN-ID Filter” file and it will show the CAN messages procedure for setting.

	A	B	C	D	E	F
1	Mode	ID	RTR	DLC	DataL	DataH
2	0	0x107	0	8	0x00000000	0x00000000
3	0	0x115	0	8	0x123	0x456
4	0	0x115	0	8	0x70F	92345678
5	0	0x116	0	8	0x001A2B3C	80000321
6	0	0x116	0	8	0x0CC56AB2	0x1AE256AB
7	0	0x108	0	8	0x00000000	0x00000000

CAN-ID Filter data in the Excel

No	MODE	ID(hex)	RTR	DLC	D1	D2	D3	D4	D5	D6	D7	D8	TimeStamp(sec)
1	0	107	0	8	00	00	00	00	00	00	00	00	2243.6602
2	0	507	0	1	00								2243.6611
3	0	115	0	8	23	01	00	00	56	04	00	00	2243.7809
4	0	515	0	8	23	01	00	00	56	04	00	00	2243.7820
5	0	115	0	8	0F	07	00	00	78	56	34	92	2243.9686
6	0	515	0	8	0F	07	00	00	78	56	34	92	2243.9697
7	0	116	0	8	3C	2B	1A	00	21	03	00	80	2244.2057
8	0	516	0	8	3C	2B	1A	00	21	03	00	80	2244.2068
9	0	116	0	8	B2	6A	C5	0C	AB	56	E2	1A	2244.4035
10	0	516	0	8	B2	6A	C5	0C	AB	56	E2	1A	2244.4046
11	0	108	0	8	00	00	00	00	00	00	00	00	2244.5937
12	0	508	0	1	00								2244.9990

CAN messages for “CAN-ID Filter” setting

5 History of Version

Version	Author	Date	Description of changes
1.0	Edward	25-Aug-2008	1. The First Version
1.1	Edward	21-Apr-2010	1. Add Configuration mode : [1] add CAN-ID filter function [2] add user-defined CAN baud
1.2	Edward	01-Sep-2010	1. Add CAN Bootloader function in firmware v1.02 or newer for firmware update. 2. Provide I-7532 Utility for configuration easily and quickly.
1.3	Edward	04-Oct-2011	1. In Configuration mode, add CAN-ID Mapping function and supported by I-7532 Utility. 2. Solve the firmware update function problem.
1.4	Edward	2015/10/19	1. Add the CAN-ID mapping example in section 2.5.5.
1.5	Edward	2016/06/27	1. FW_v1.04 and Utility_v1.03 already support the below CAN-ID_Mapping. (1) 11bit -> 11bit (2) 11bit -> 29bit (3) 29bit -> 11bit (4) 29bit -> 29bit 2. Add the Q02 of FAQ.
1.6	Edward	2018/06/13	1 Add the Q03 of FAQ.