



# iKAN Series Message Display

## User Manual

V 1.1.1, June. 2024



iKAN-116(A)/iKAN-116S/iKAN-124(A)/iKAN-124S

iKAN-208(A)/iKAN-216(A)/iKAN-224(A)



Technical Support: [service@icpdas.com](mailto:service@icpdas.com)

Author: Tony Lee

Editor: Anna Huang

## Warranty

---

All products manufactured by ICP DAS are under warranty regarding defective materials for a period of one year, beginning from the date of delivery to the original purchaser.

## Warning

---

ICP DAS assumes no liability for any damage resulting from the use of this product. ICP DAS reserves the right to change this manual at any time without notice. The information furnished by ICP DAS is believed to be accurate and reliable. However, no responsibility is assumed by ICP DAS for its use, nor for any infringements of patents or other rights of third parties resulting from its use.

## Copyright

---

Copyright © 2021 by ICP DAS Co., Ltd. All rights are reserved.

## Trademark

---

Names are used for identification only and may be registered trademarks of their respective companies.

## Contact US

---

If you have any problem, please feel free to contact us by email at: [Service@icpdas.com](mailto:Service@icpdas.com). You can count on us for quick response.

# Contents

<b>1.</b>	<b>Introduction.....</b>	<b>6</b>
1.1.	Features.....	7
1.2.	Specification .....	9
1.3.	Overview .....	12
1.4.	Wire Connection .....	15
1.5.	Dimension.....	17
<b>2.</b>	<b>Getting Started .....</b>	<b>21</b>
2.1.	Checking the Package.....	21
2.2.	Assembling the iKAN.....	24
2.2.1.	Installing a Single-Panel iKAN Display .....	24
2.2.2.	Installing a Two-Panel iKAN Display .....	25
2.2.3.	Installing Three-Panel iKAN Display .....	27
2.3.	Connecting to the Power and PC .....	30
2.4.	Connecting the iKAN to a Network.....	31
2.5.	Editing Your First iKAN Message.....	33
<b>3.</b>	<b>Configuration.....</b>	<b>36</b>
3.1.	Web Interface .....	37
3.1.1.	Editing and Managing Messages.....	38
3.1.2.	Applying the Variable Maps .....	39
3.1.2.1.	Mapping Physical Values to Integer-Type Variables.....	41
3.1.2.2.	Changing the Number of Decimal Places for the Value of a Float-type Variable .....	42
3.1.2.3.	Assigning Strings to Coil Variables .....	43
3.1.3.	DIO .....	44
3.1.4.	DL Status.....	45

3.1.5.	System .....	46
<b>3.2.</b>	<b>System Configuration .....</b>	<b>49</b>
3.2.1.	Exporting pre-configured messages.....	49
3.2.2.	Ethernet Configuration .....	53
3.2.3.	Serial Port Configuration .....	55
3.2.4.	MISC .....	57
<b>3.3.</b>	<b>eSearch Utility.....</b>	<b>63</b>
3.3.1.	Configuring the IP Address.....	64
3.3.2.	Sending the Modbus Command to iKAN .....	66
3.3.2.1.	Sending Modbus RTU Command to the iKAN Display .....	67
3.3.2.2.	Send Modbus TCP Command to the iKAN display .....	69
<b>4.</b>	<b>Messages.....</b>	<b>71</b>
<b>4.1.</b>	<b>Editing and Managing Messages .....</b>	<b>71</b>
<b>4.2.</b>	<b>Displaying Messages with Variables .....</b>	<b>75</b>
4.2.1.	Inserting System Variables into a Message .....	80
4.2.1.1.	Displaying the IP Address .....	80
4.2.1.2.	Displaying the Current Date and Time .....	83
4.2.2.	Inserting Integer-type Variables into a Message .....	86
4.2.3.	Inserting float-type Variables into a Message .....	89
4.2.4.	Inserting Coil –type Variables into a Message .....	92
4.2.5.	Inserting ASCII Strings into a Message.....	95
4.2.6.	Inserting Unicode Strings into a Message.....	99
<b>4.3.</b>	<b>Displaying a Value Applied using a Variable Map .....</b>	<b>103</b>
4.3.1.	Displaying Mapping Data for Integer-type Variables .....	104
4.3.2.	Displaying a Value with a Specified Number of Decimal Places for Float-type Variables	107
4.3.3.	Displaying the Value of a Coil Variable using Replacement Text.....	109

<b>5.</b>	<b>Displaying Data from CL/DL series modules.....</b>	<b>112</b>
5.1.	Displaying Data from CL/DL Modules Connected to Ethernet.....	114
5.2.	Displaying Data from CL/DL Modules Connected to RS-485.....	124
<b>Appendix. Variable Types and Modbus Register Map .....</b>		<b>133</b>
<b>Revision History .....</b>		<b>140</b>

# 1. Introduction

The iKAN series is a family of industrial Modbus LED display devices that deliver industrial-grade anti-noise capabilities, as well as reliability and stability. ASCII characters and Unicode characters, which can be used to display multiple languages like Thai, Arabic, Hebrew, Hindi or Japanese, are supported for presenting formatted messages. Support for the popular Modbus industrial protocol is provided meaning that the iKAN display device can be easily integrated into existing PLC and SCADA environments.

Messages can be edited using a standard web browser, such as Google Chrome, Firefox, or IE on a PC, mobile device, or smartphone without any limitations related to specific control tools or programs. Each model in the iKAN series provides storage space for up to 128 messages with user-defined priority. In addition, 168 variables allow data on a PC, PLC or other controller to be automatically integrated into a message and then displayed. With an open user interface and the ability to display real-time data from other devices, the iKAN series message displays can be applied in shopping malls, railway stations, industrial areas, or in situations where visual display is the easiest way of delivering your message.

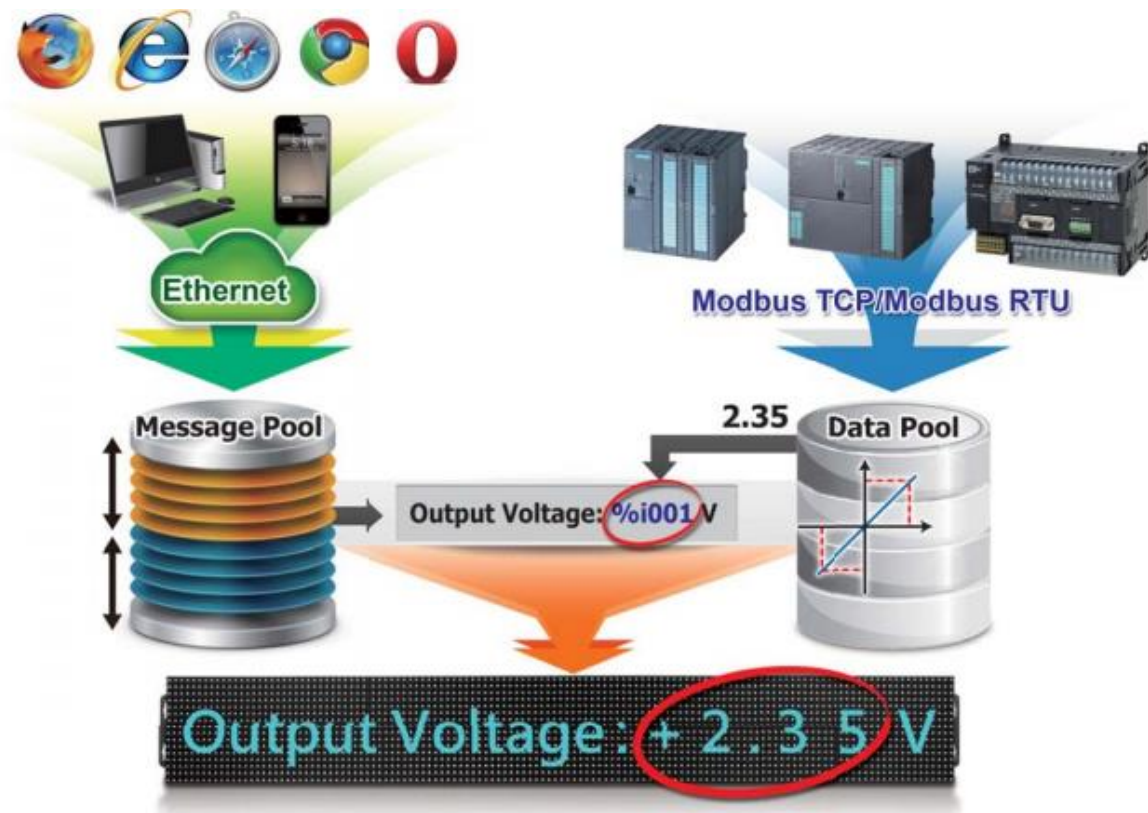

## 1.1. Features

---

The following is a brief summary of the features and capabilities of iKAN displays.

### PLC HMI

The iKAN series can be employed as a large HMI with a memory storage of up to 128 messages with user-defined priority, each of which can be used to display information generated by a PLC. Message text can be displayed in a range of seven colors, including red, blue, yellow, green, light blue, purple, and white, which can be used to indicate warnings or alarms, as well as increasing the readability of a message.



V o l t a g e : 2 . 3 5 V



M a c h i n e A 0 1 : A c t i v e



C O 2 : 7 2 5 P P M

### Support for Multiple Languages

The iKAN series of display device supports Unicode input, meaning that messages can be configured to be displayed in multiple languages.

### Message Editing

A maximum of 128 messages with user-defined priority can be preconfigured from the first moment that the iKAN series display is switched on. When the display is in operation, the focus needs only be on message management rather than the need to frequently update the messages.

## Message Priority

Instant messages have a higher priority than common messages. Once an instant message is enabled, the common message currently being displayed will be suspended until the instant message is disabled. This feature allows the most important information to be displayed in an emergency situation.

## Integer-type variables enable data mapping

The iKAN series of display devices provide the ability to perform data mapping by translating a value of integer-type variable to a readable physical quantity, such as the voltage, temperature, or relative humidity, etc. In the industrial field, this is a commonly performed task when a host computer reads data from a data-acquisition device via the Modbus protocol, the function of data mapping enables a reduction in the resources and programming required for the host computer

## Import/Export the message configuration

The iKAN series allows a message and the parameters of the variables to be saved as a configuration file, which can then be loaded onto another iKAN series device to avoid the need to repeat the configuration.

## Smartphone Application

Users can manage messages via a regular smartphone without requiring a specific connection device, meaning that emergency information can be quickly sent to the display using the smartphone.



## 1.2. Specification

The table below summarizes the specifications of the iKAN series of displays.

### iKAN-116/iKAN-116S/iKAN-124/iKAN-124S

Model	iKAN-116	iKAN-116S	iKAN-124	iKAN-124S
<b>Display</b>				
Color	Red, Blue, Yellow, Green, Light Blue, Purple or White			
Character Sets	16 x 16 Unicode or 8 x 16 ASCII			
Display Size	Line	1		
	ASCII	16 characters	24 characters	
	Unicode	8 characters	12 characters	
Message Pool	128 common messages with user-defined priority levels Up to 20 Unicode characters or 50 ASCII characters each			
Data Pool	40 Coil values, 64 Float values, and 64 Integer values			
RTC (Real-time Clock)	Date and time, 24 hour format, including hours, minutes, seconds, day of the week, date, month, year			
<b>Ethernet</b>				
Port	2 x RJ-45, 10/100 Base-TX			
Protocol	Modbus TCP Master/Slave, Max. 8/8 connections			
Configuration	Web-based User Interface			
<b>COM Port</b>				
Interface	2 x RS-485			
Baud rate (bps)	1200, 2400, 4800, 9600, 19200, 38400, 57600, 115200			
Data Format	N81, E81, O81			
Protocol	Modbus RTU Master/Slave			
<b>Mechanical</b>				
Dimensions (W x H x D, unit: mm)	1346 x 160 x 49	835 x 115 x 37.5	1986 x 160 x 49	1218 x 115 x 37.5
Weight	4.0 Kg	2.0 Kg	4.6 Kg	2.5 Kg
Installation	Wall mounting			
Casing	Aluminum			

Model	iKAN-116	iKAN-116S	iKAN-124	iKAN-124S
<b>Power</b>				
Input Range	100 ~ 240 VAC			
Consumption	0.3A @ AC 120 V		0.35 A @ AC 120 V	
<b>Environment</b>				
Operating Temperature	0 ~ 60°C			
Storage Temperature	-10 ~ 75°C			
Humidity	10 ~ 90% RH, Non-condensing			

## iKAN-208/iKAN-216/iKAN-224

Model	iKAN-208		iKAN-216	iKAN-224
<b>Display</b>				
Color	Red, Blue, Yellow, Green, Light Blue, Purple or White			
Character Sets	16 x 16 Unicode or 8 x 16 ASCII			
Display Size	Line	2		
	ASCII	16 characters	32 characters	48 characters
	Unicode	8 characters	16 characters	24 characters
Message Pool	128 common messages with user-defined priority Up to 20 Unicode characters or 50 ASCII characters each			
Data Pool	40 Coil values, 64 Float values, and 64 Integer values			
RTC (Real-time Clock)	Date and time, 24 hour format, including hours, minutes, seconds, day of the week, date, month, year			
<b>Ethernet</b>				
Port	2 x RJ-45, 10/100 Base-TX			
Protocol	Modbus TCP Master/Slave, Max. 8/8 connections			
Configuration	Web-based User Interface			
<b>COM Port</b>				
Interface	2 x RS-485			
Baud rate (bps)	1200, 2400, 4800, 9600, 19200, 38400, 57600, 115200			
Data Format	N81, E81, O81			
Protocol	Modbus RTU Master/Slave			
<b>Mechanical</b>				
Dimensions (W x H x D, unit: mm)	707 x 320 x 50	1346 x 160 x 49	1986 x 160 x 49	
Weight	4 Kg	8 Kg	12 Kg	
Installation	Wall mounting			
Housing Material	Aluminum			
<b>Power</b>				
Input Range	100 ~ 240 VAC			
Consumption	0.3 A @ AC 120 V	0.4 A @ AC 120 V	0.5 A @ AC 120 V	
<b>Environment</b>				
Operating Temperature	0 ~ 60°C			
Storage Temperature	-10 ~ 75°C			
Humidity	10 ~ 90% RH, Non-condensing			

## 1.3. Overview

---

The iKAN series display is equipped with a number of interfaces and peripherals that can be integrated with external systems. Here is an overview of the components and a description of each.

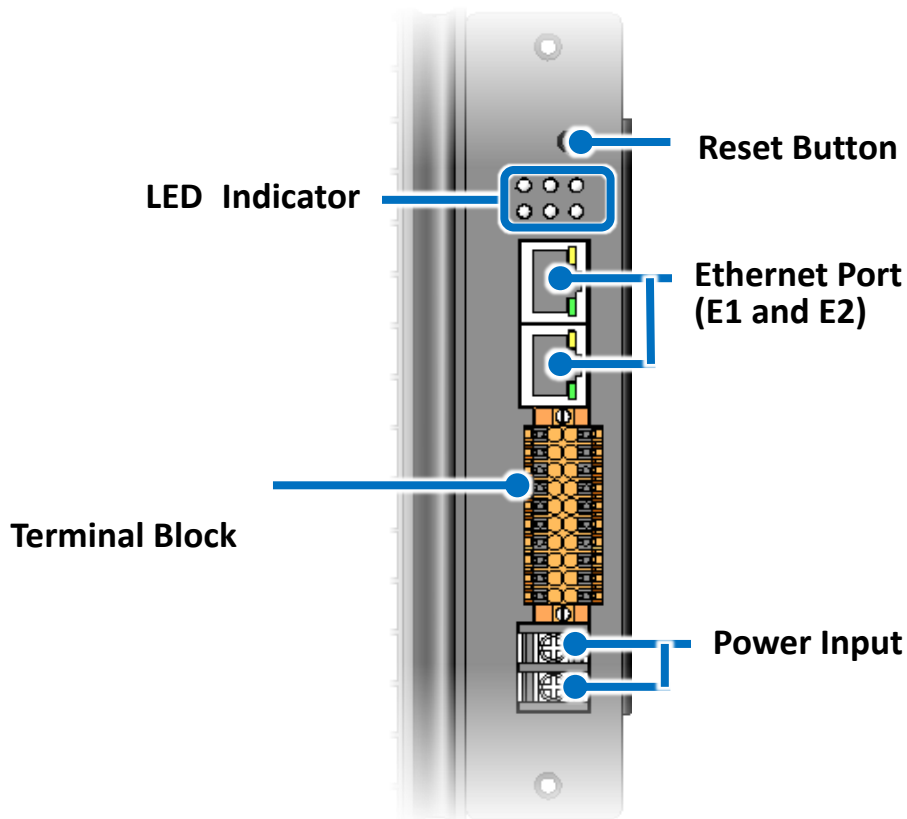

The details of these items are as follows:

- **Reset Button**

The reset button is used to check the IP address and restore all settings to the factory default.

By pressing the Reset button for 5 seconds, the IP address for the iKAN series device will be shown on the display. This is very useful, especially when you have forgotten the IP address needed to access the iKAN series display.

By pressing the Reset button for 8 seconds, all messages and variable configuration settings will be reset to the factory defaults.

- **LED Indicator**

The iKAN series display contains six LED indicators that display the status of the iKAN series display. The details are:

LED Indicator/Label	State	Meaning
PWR	Red	The power is on.
	Red-Blinking	The OS is functioning.
Reset	Red	The Reset button is activated.
DI1, DO1	Orange	These LED indicators are used to indicate the status of the Digital I/O.
DIO, DO0	Green	These LED indicators are used to indicate the status of the Digital I/O.

- **Ethernet Port (E1 and E2)**

The iKAN series display contains two Ethernet ports that can be used to connect a router to the Internet, or to other devices.

Each Ethernet port provides two LED indicators that display the connection status. The details are:

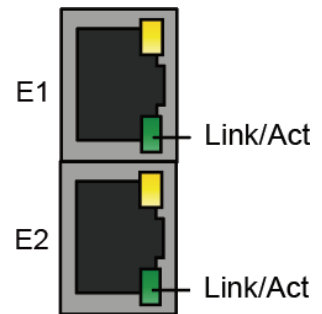

LED Indicator/Label	Label	State	Meaning
E1 、 E2	Link/Act	Green	The Link is active.
		-	The Link is inactive.
		Green-Blinking	Network activity.

- **Terminal Block**

The iKAN series display contains a terminal block with 20 poles, as illustrated below. For more information related to the identification of the wiring connections, refer to **Section 1.4. Wire Connection**.

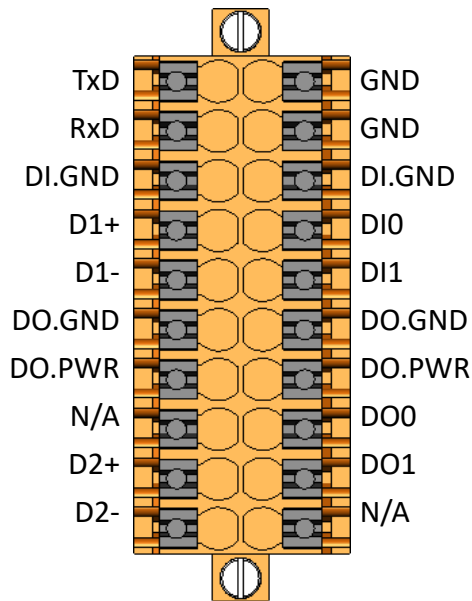

COM Ports	
COM1: RS-485	D1+ and D1-
COM2: RS-232	TxD, RxD and GND
COM3: RS-485	D2+ and D2-

Digital Input/Digital Output	
Digital Input 1	DI0 and DI.GND
Digital Input 2	DI1 and DI. GND
Digital Output 1	DO.PWR, DO0 and DO.GND
Digital Output 2	DO.PWR, DO1 and DO.GND

## 1.4. Wire Connection

The iKAN series display contains a terminal block which provides access to a number of communication formats. The following illustrates the wiring information for the terminal block.

### RS-232 Wiring

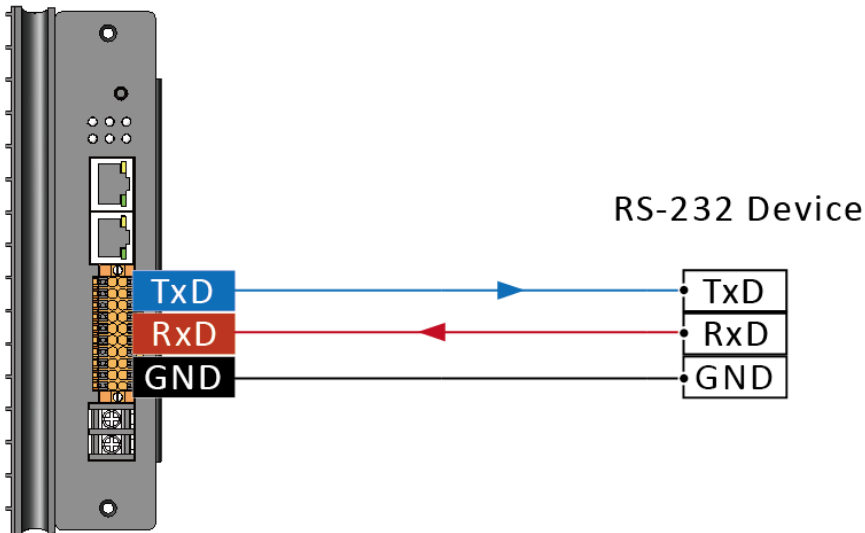

### RS-485 Wiring

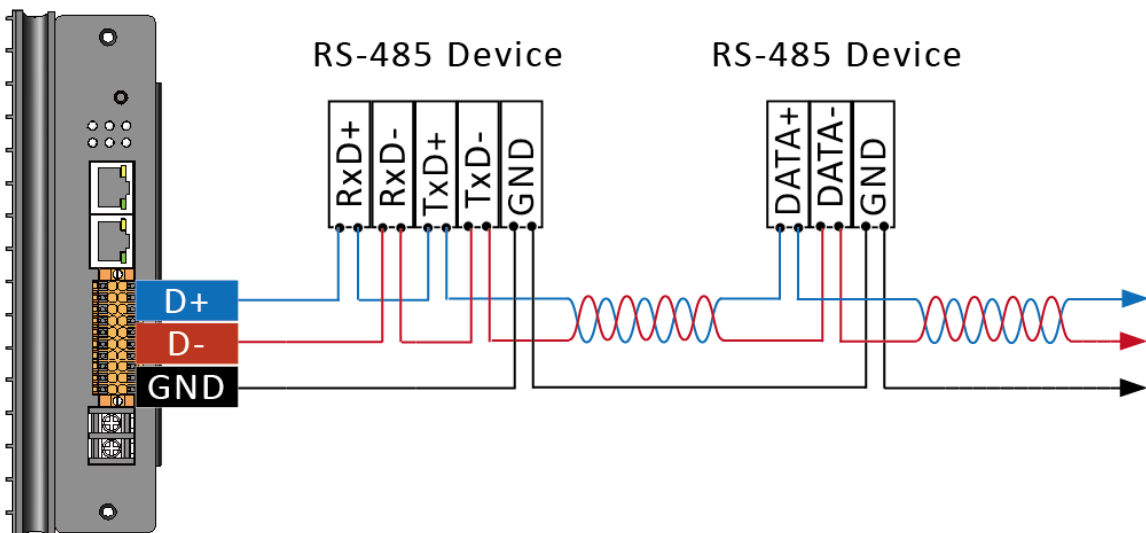

## DI Wiring

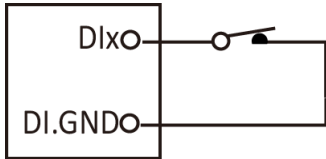
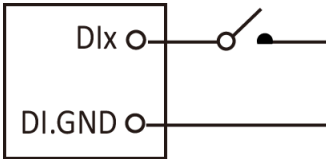
Input Type	On State as 0	OFF State as 1
Dry Contact	Close to GND	Open
		

## DO Wiring

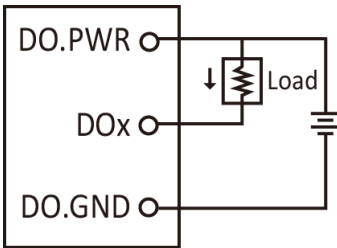
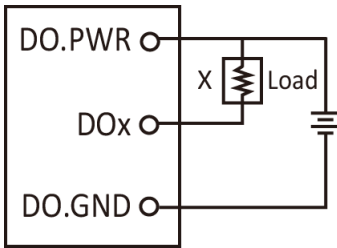
Input Type	On State Readback as 1	OFF State Readback as 0
DO (Sink, NPN)	+5 to +24 VDC	Open
		



# 1.5. Dimension

The diagrams below provide details of the dimensions for the iKAN series of displays that can be used when defining the specifications for any enclosures to be installed. All dimensions are in millimeters.

## iKAN-116S

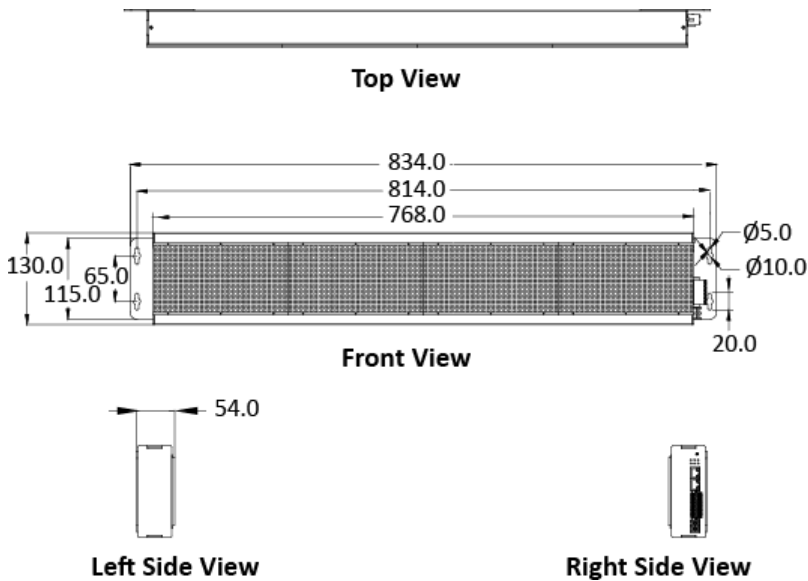

## iKAN-124S

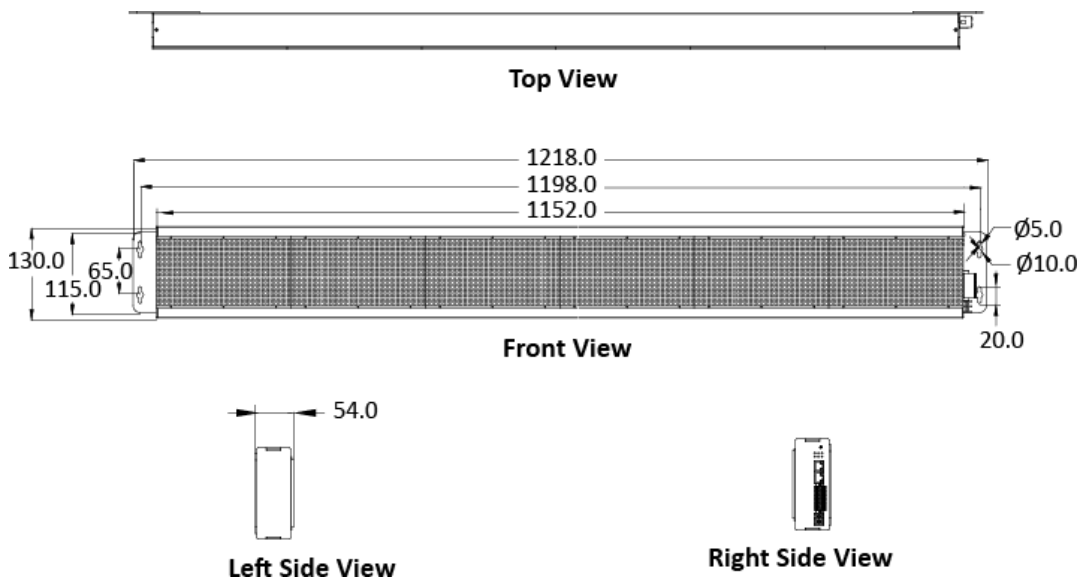

## iKAN-116

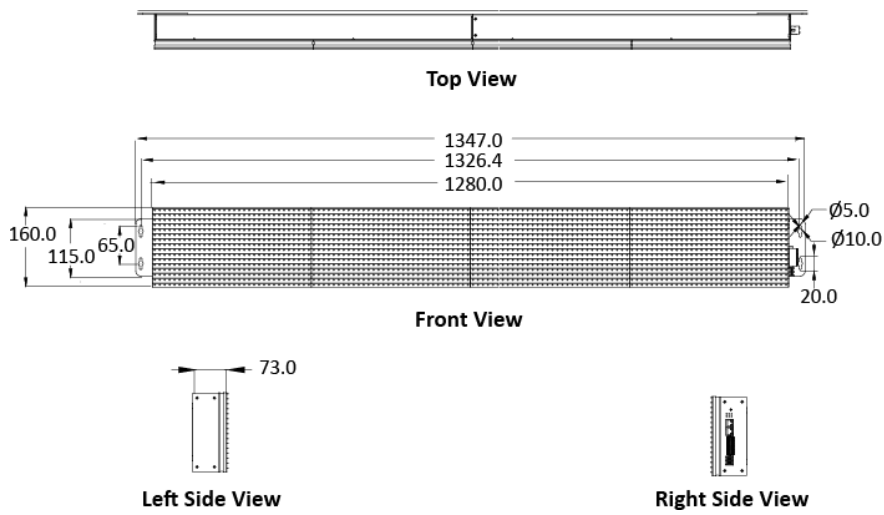

## iKAN-124

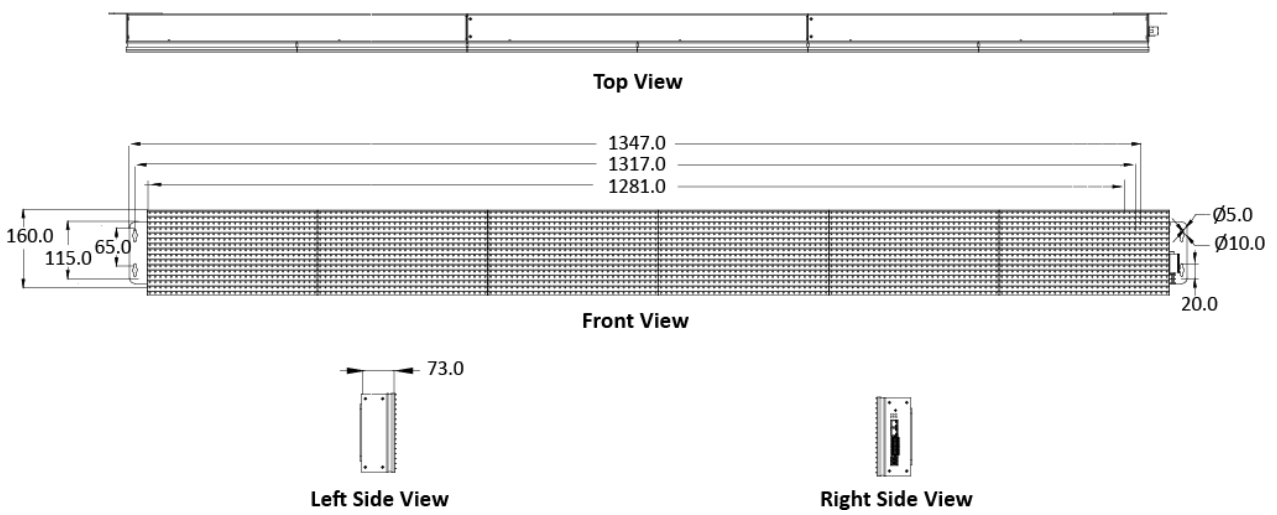

## iKAN-208

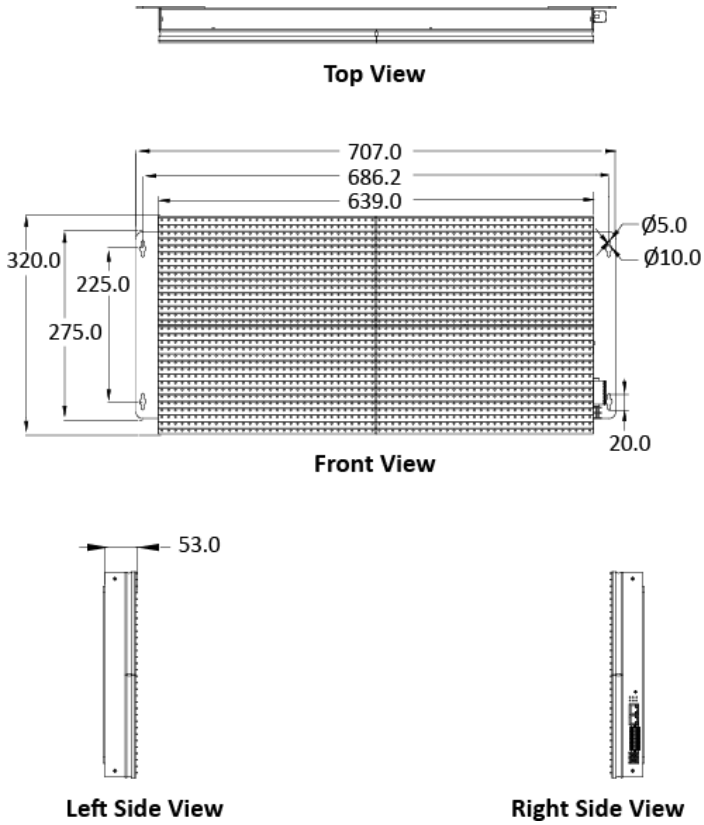

## iKAN-216

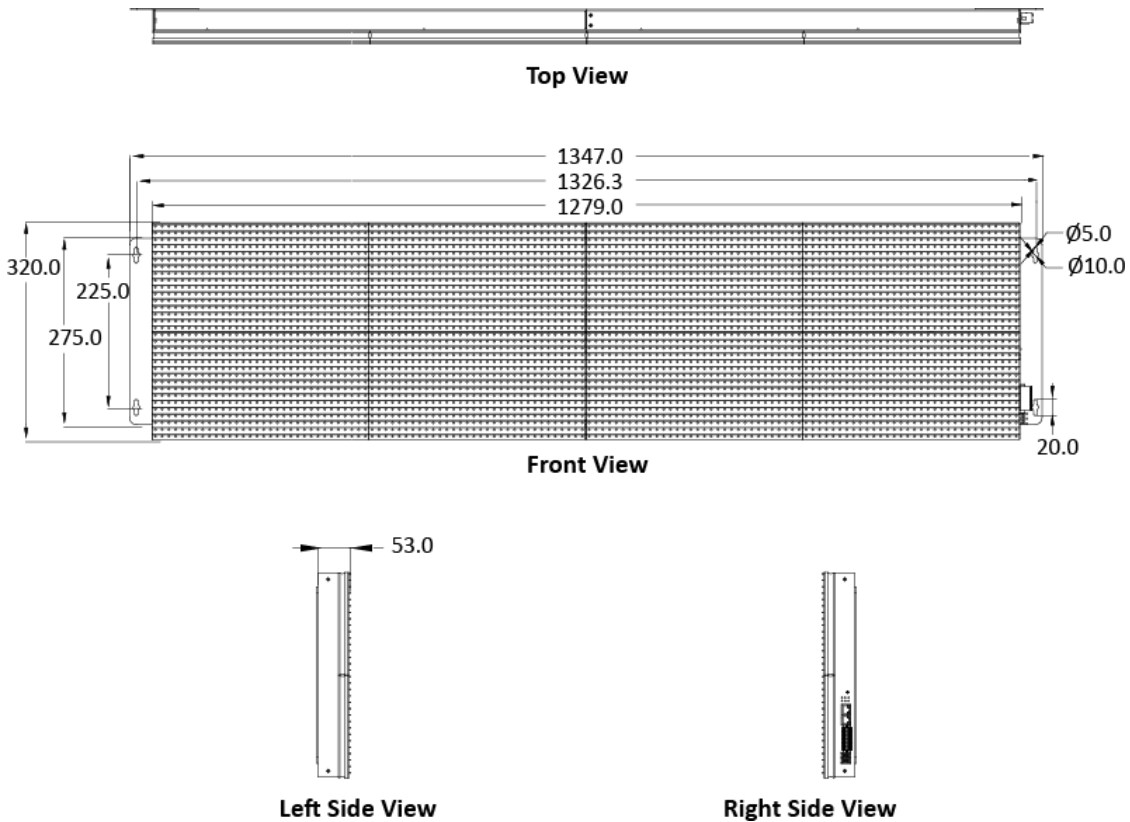

# iKAN-224

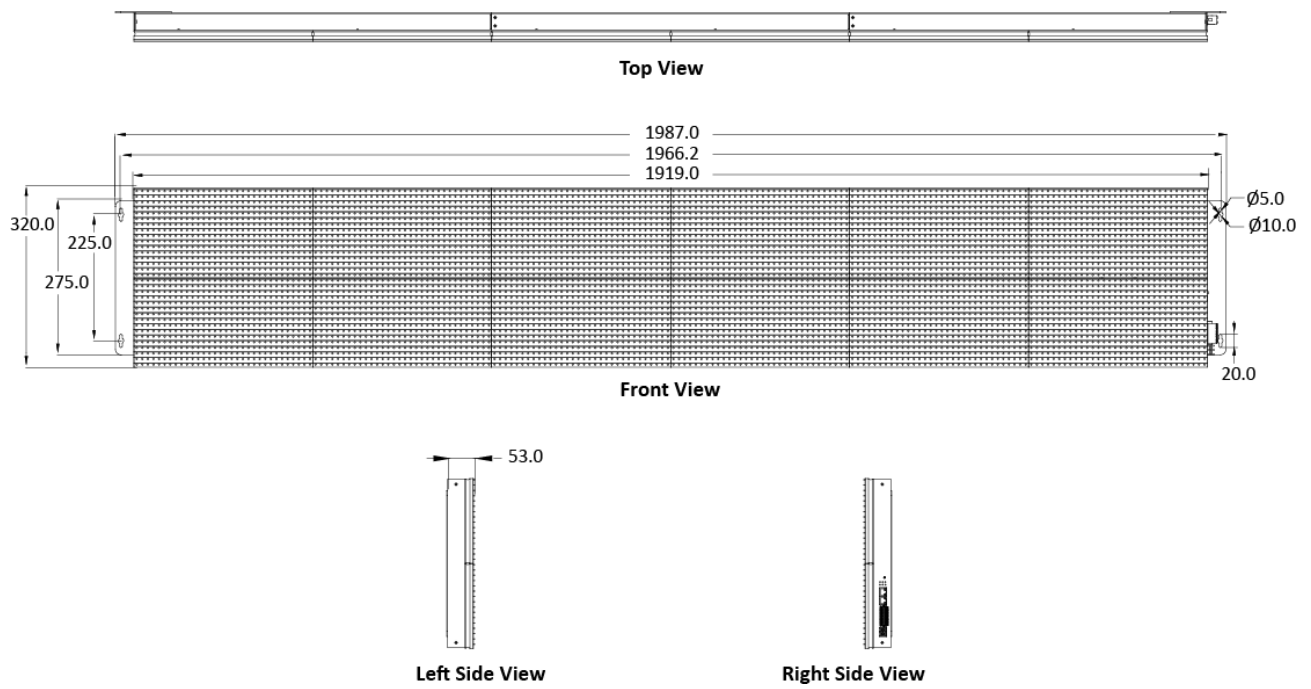

## 2. Getting Started

---

If you are new to iKAN, you should read this chapter first, as it provides a description of the basic procedures that need to be followed when installing, configuring, and activating the iKAN system, before operating the iKAN for the first time.

### 2.1. Checking the Package

---

Before starting any task, check the contents of the shipping package. If any of the following items are missing or damaged, contact your dealer or distributor.

- For Single-Panel iKAN Display: **iKAN-116S, iKAN-124S and iKAN-208**

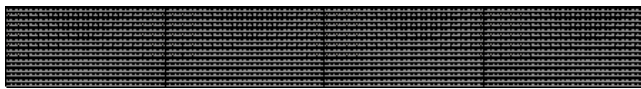

**iKAN-116S/iKAN-124S/iKAN-208**

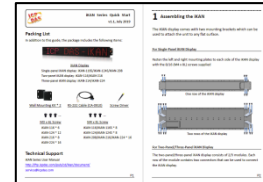

**Quick Start Guide**



**Wall Mounting Kit \* 2**



**CA-0910**

RS-232 Cable



**Screw Driver**



**M4x6L Screw**

iKAN-116S: Screw \* 8

iKAN-124S: Screw \* 8

iKAN-208: Screw \*16

• For Two-Panel iKAN Display: iKAN-116 and iKAN-216

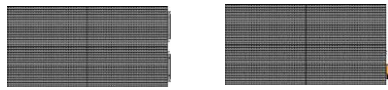

**iKAN-116/iKAN-216**

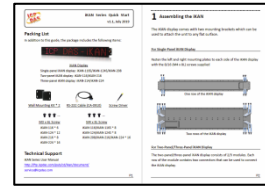

**Quick Start Guide**



**Wall Mounting Kit \* 2**



**CA-0910**

RS-232 Cable



**Screw Driver**



**M4x6L Screw**

iKAN-116: Screw \* 8

iKAN-216: Screw \*16



**M3x6L Screw**

iKAN-116: Screw \* 6

iKAN-216: Screw \*8

• For Three-Panel iKAN Display: iKAN-124 and iKAN-224

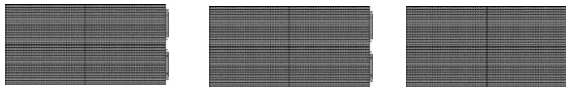

**iKAN-124/iKAN-224**

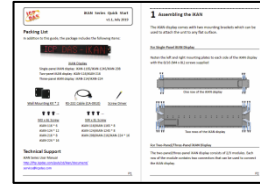

**Quick Start Guide**



**Wall Mounting Kit \* 2**



**CA-0910**

RS-232 Cable



**Screw Driver**



**M4x6L Screw**

iKAN-124: Screw \* 8

iKAN-224: Screw \*16



**M3x6L Screw**

iKAN-124: Screw \* 12

iKAN-224: Screw \*16

## 2.2. Assembling the iKAN

---

Before installation, ensure that the surface dedicated for installation is suitable for supporting the weight of the device. We do not recommend soft and fragile surfaces, such as polystyrene foam, mineral wool, plaster boards, or wooden walls with a thickness of less than 30 mm.

### 2.2.1. Installing a Single-Panel iKAN Display

Fasten the left and right mounting plates to each side of the iKAN display with the 8/16 screws supplied.

#### iKAN-116S/iKAN-124S

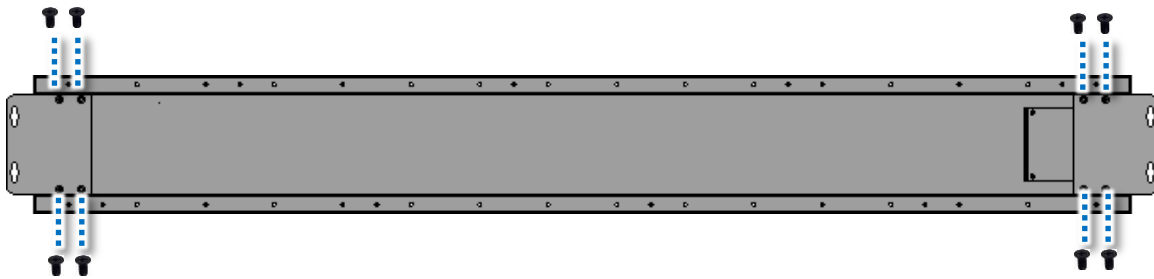

#### iKAN-208

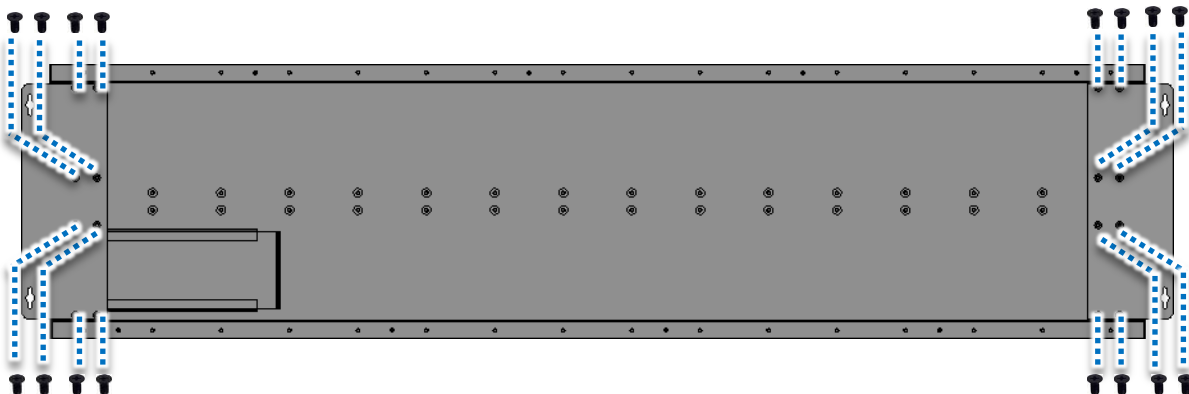



## 2.2.2. Installing a Two-Panel iKAN Display

Both the iKAN-116 and iKAN-216 consist of two modules, the left hand module and the right hand module. Each line of the module contains two connectors that can be used to connect the iKAN display.

1. Remove the connectors from the opening on the side of the module:

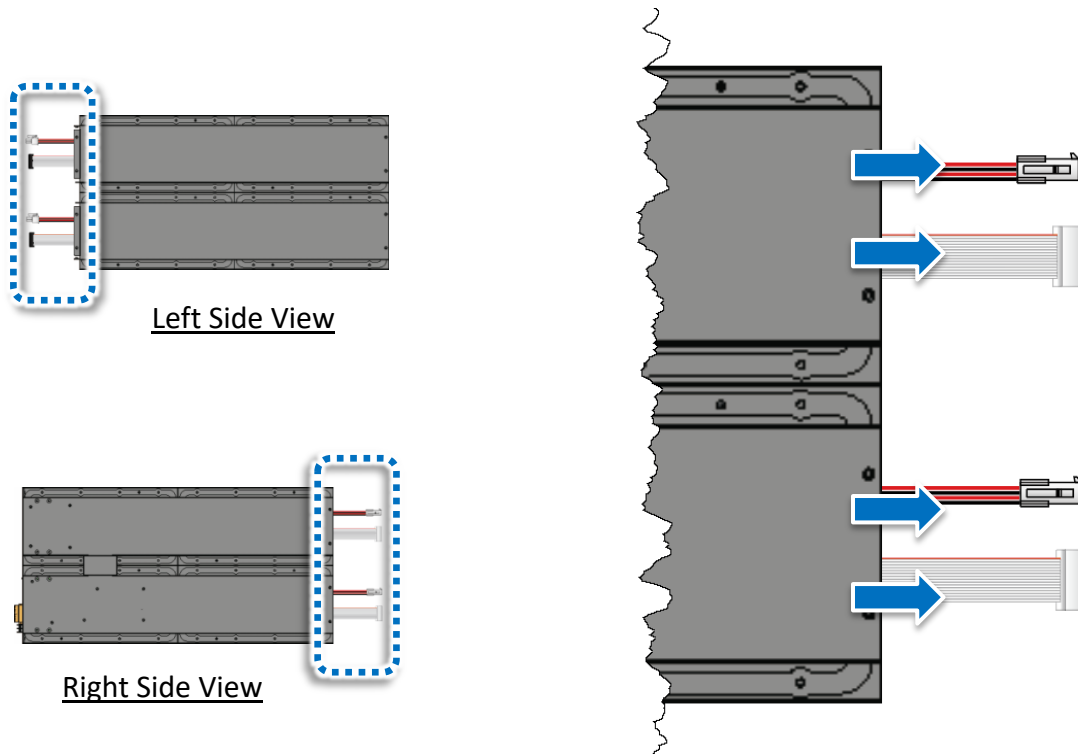

2. Connect the connectors and attach the modules

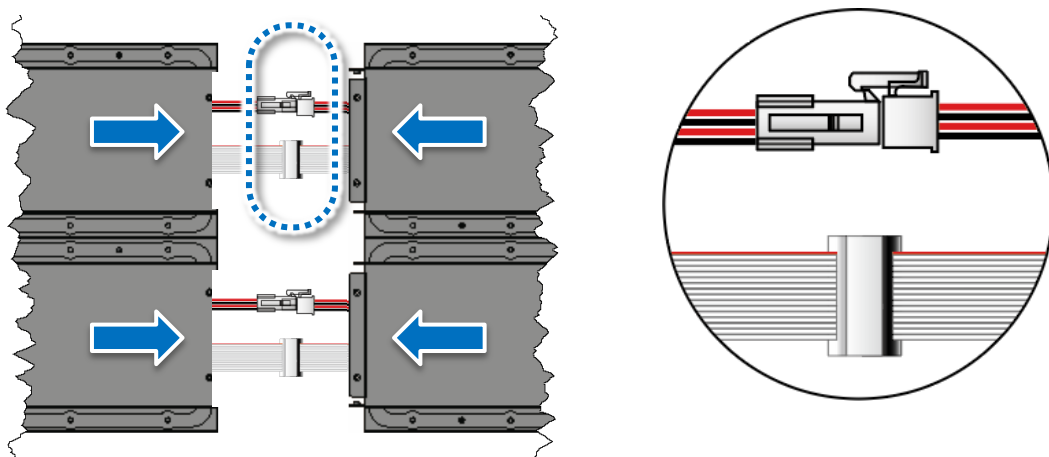

3. Fasten the modules together using the 6/8 (M3 x 6L) screws supplied

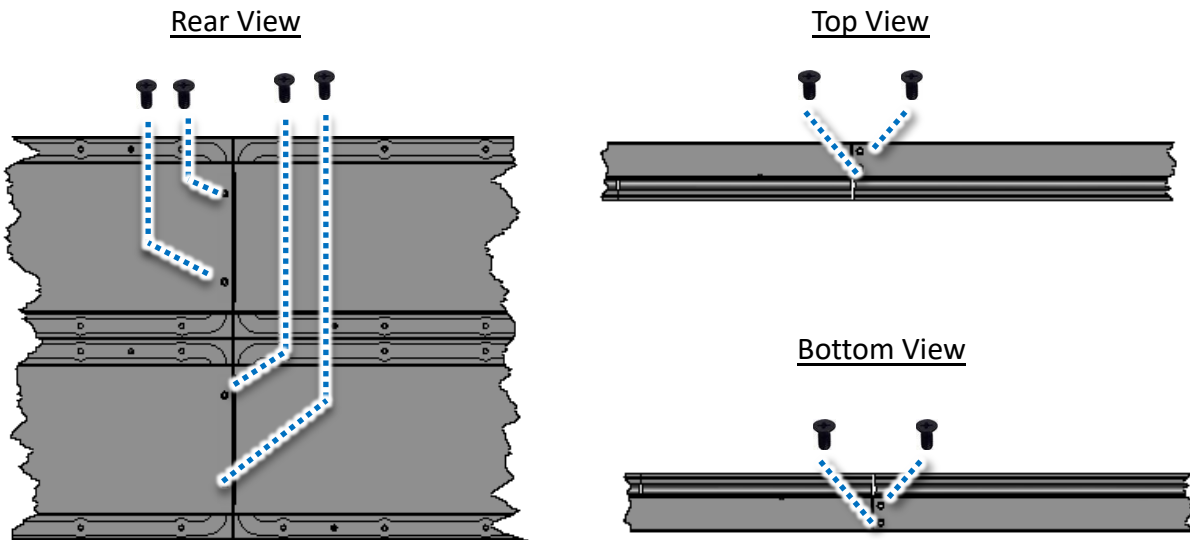

4. Fasten the left and right mounting plates to each side of the iKAN display with the 8/16 (M4 x 6L) screws supplied

#### iKAN-116

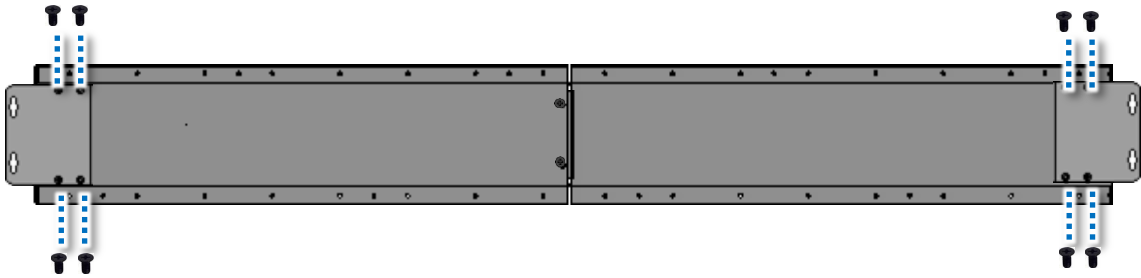

#### iKAN-216

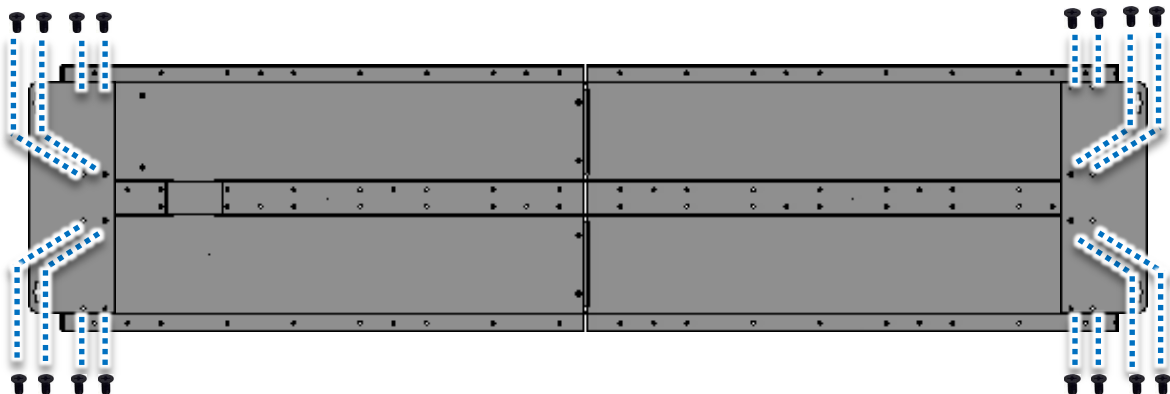

### 2.2.3. Installing Three-Panel iKAN Display

Both the iKAN-124 and iKAN-224 consist of three modules, the left hand module, the middle module, and the right hand module. Each row of the module contains two connectors that can be used to connect the iKAN display.

1. Remove the connectors from the opening on the side of the module:

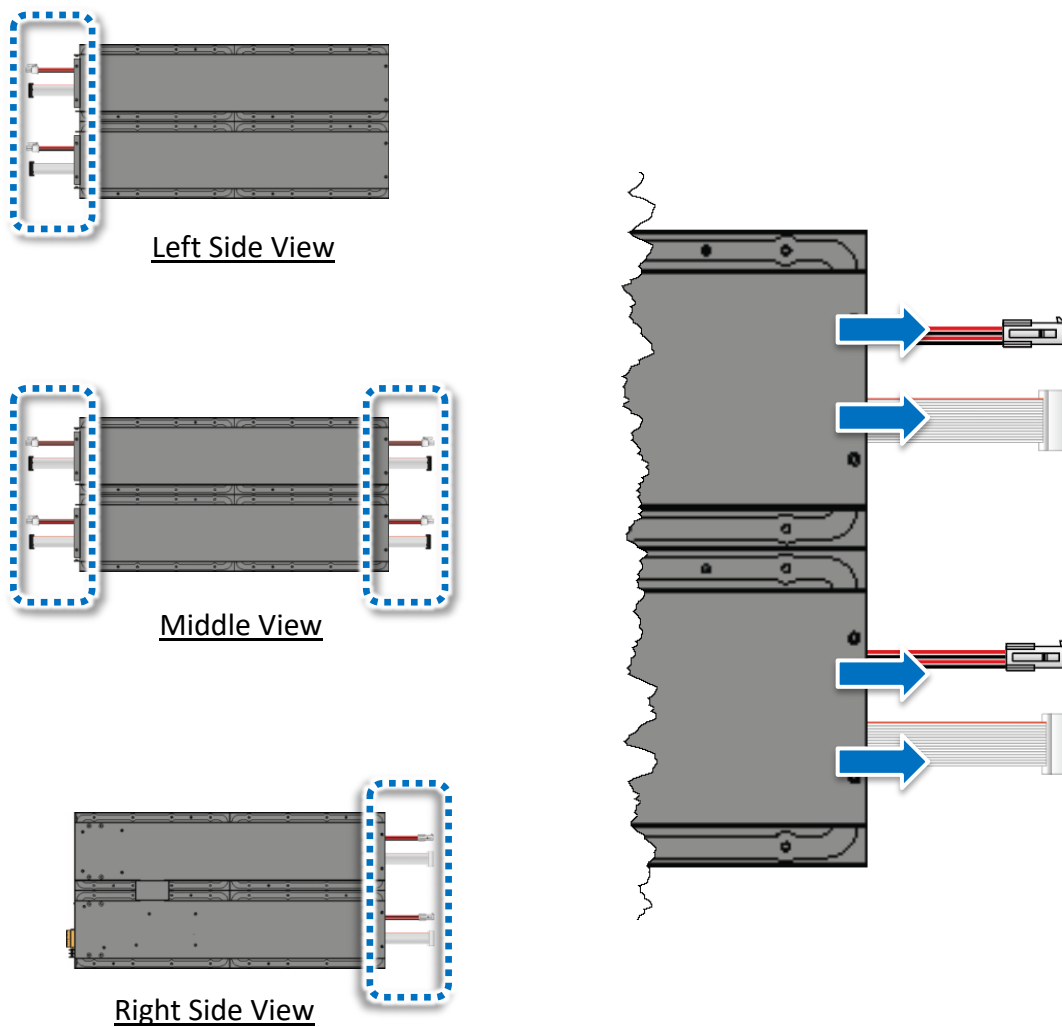

2. Connect the connectors and attach the modules

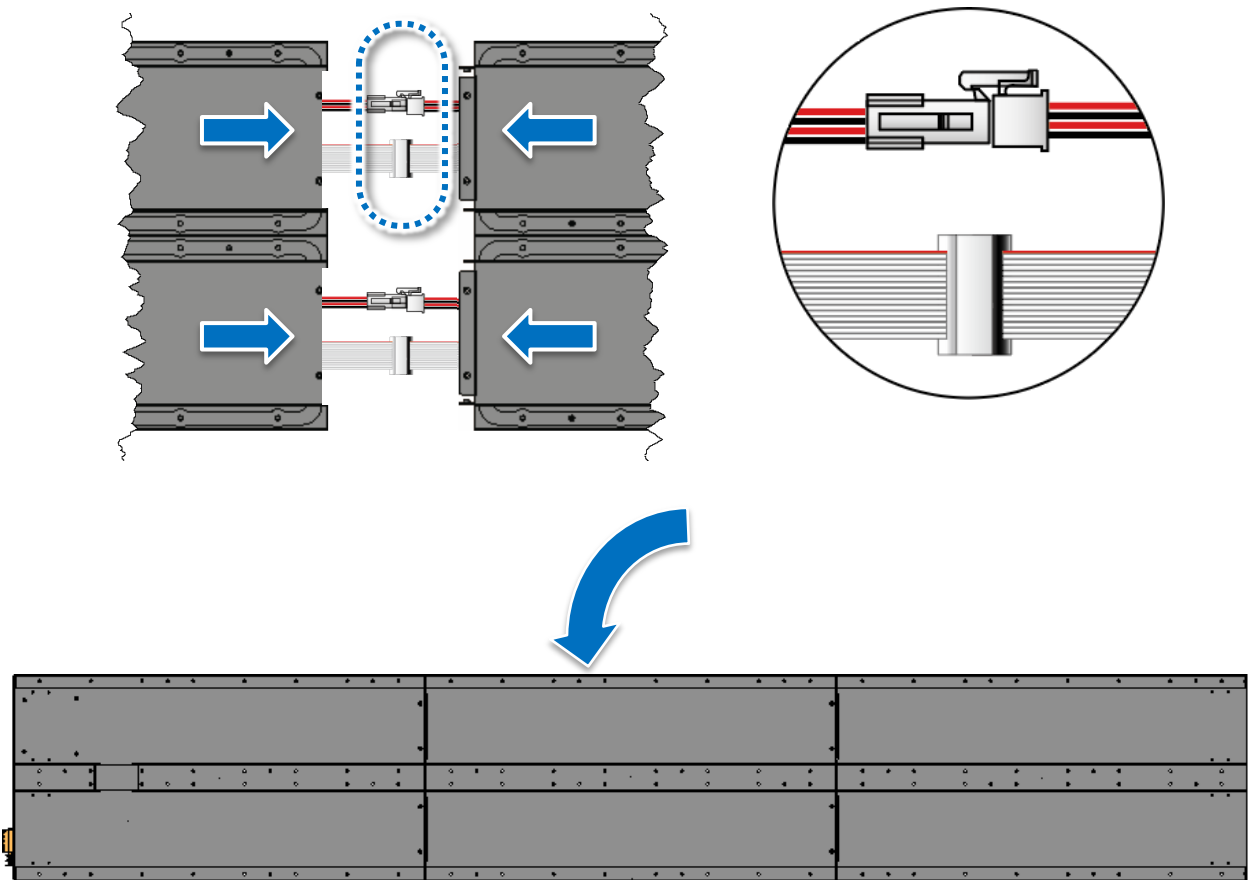

3. Fasten the modules together using the 1/16 (M3x 6L) screws supplied

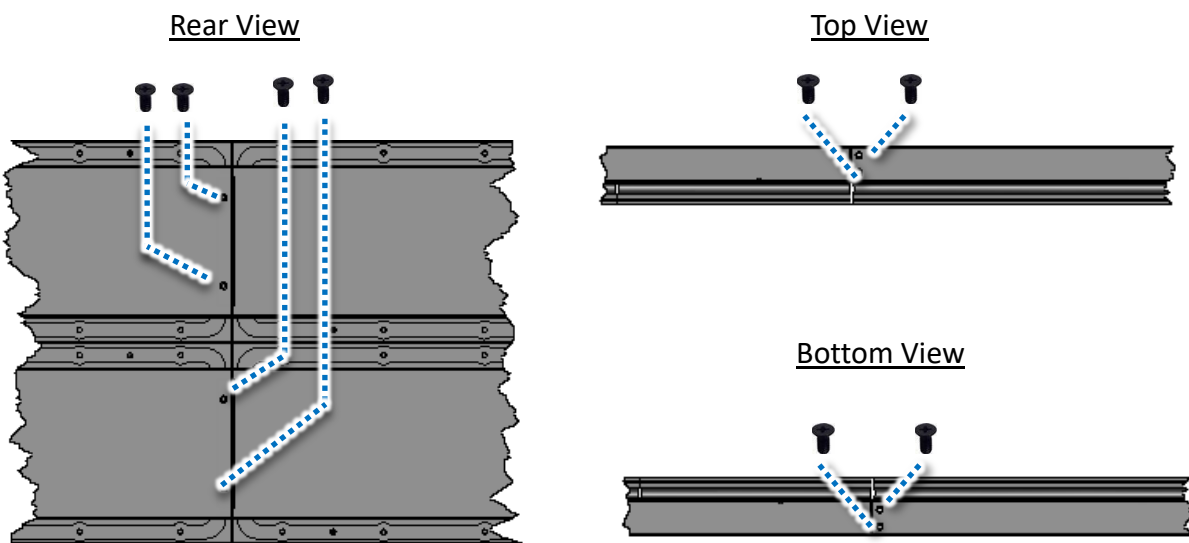

4. Fasten the left and right mounting plates to each side of the iKAN display with the 8/16 (M4 x 6L) screws supplied

#### iKAN-124

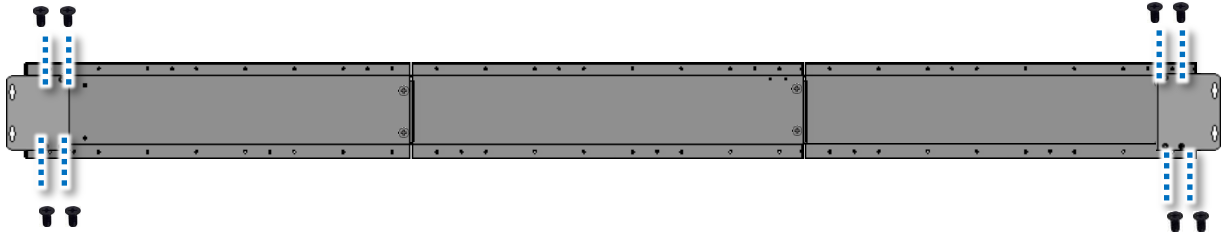

#### iKAN-224

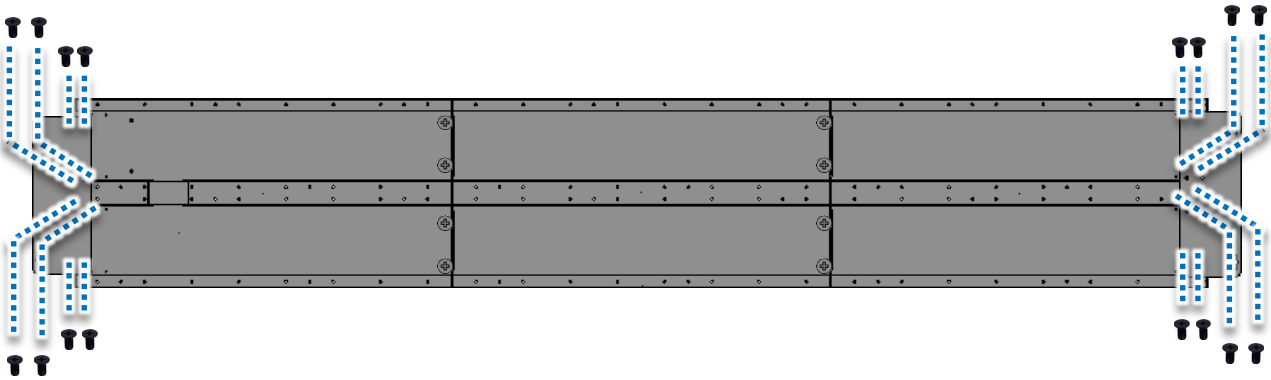

## 2.3. Connecting to the Power and PC

---

The iKAN series display includes two standard Ethernet ports (RJ-45) which provide access to the iKAN via a PC. To configure the iKAN using the PC, you must first establish a connection between the iKAN and the PC.

1. Connect the AC power to the iKAN device.
2. Connect the Ethernet cable to the Ethernet port, and then connect the other end of the cable to an available port on the network router, switch, or hub, as illustrated below

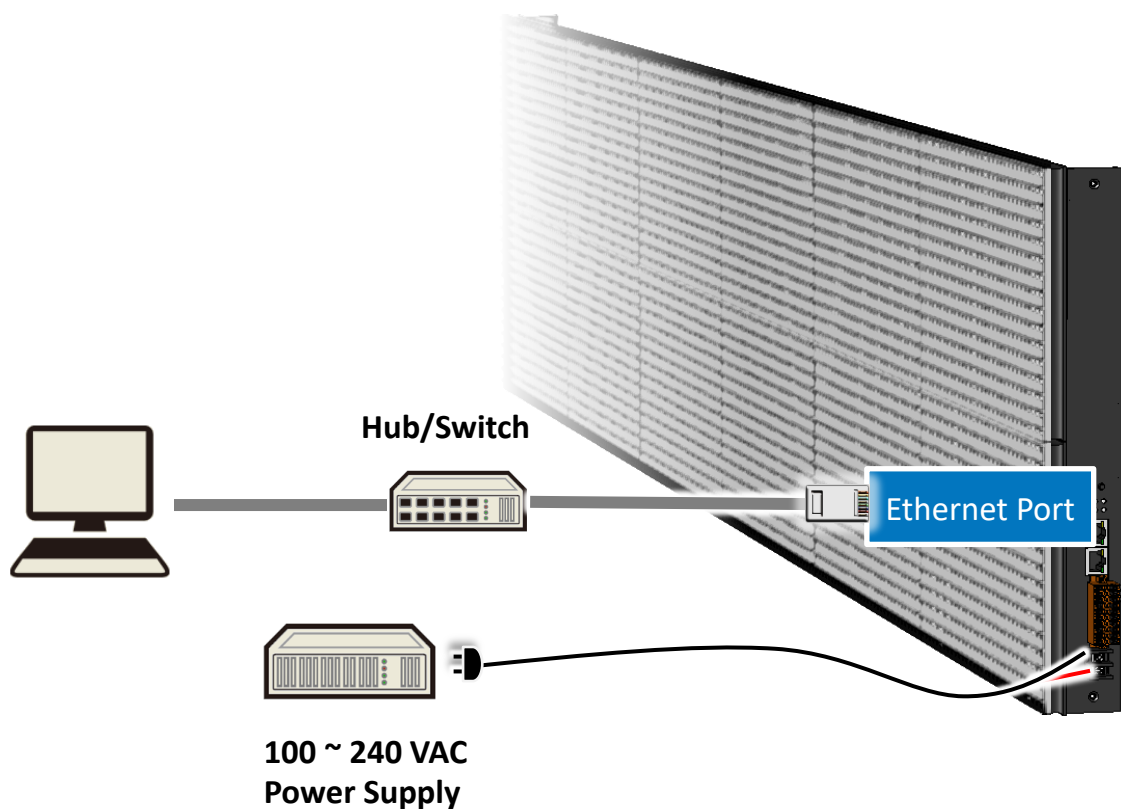

## 2.4. Connecting the iKAN to a Network

---

The factory default IP address for each iKAN device is **192.168.255.1**.

Before integrating an iKAN series display into your network, you should configure the IP, Subnet Mask, and Gateway addresses for the device by setting the values that are valid for your network system.

The eSearch Utility has been developed to allow you to search for ICP DAS Ethernet I/O modules based-on MiniOS7 which are connected to the same subnetwork as the Host PC, and then you can configure the Ethernet parameters such as the IP Address, Subnet Mask and Gateway.

### 1. Download the latest version of the eSearch Utility



The eSearch Utility can be obtained from:

<https://www.icpdas.com/en/download/index.php?nation=TW&kw=esearch>

Default Installation Path:

C:\ICPDAS\eSearch

### 2. Launch the eSearch utility and click the Search Server button

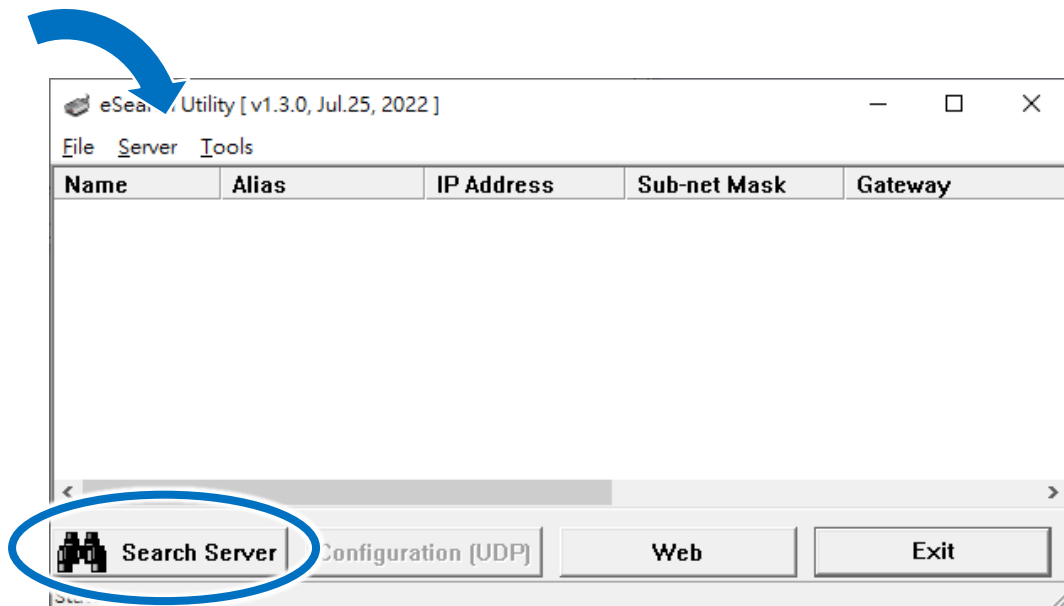

3. Once the search process has completed, double-click the name of iKAN display to open the **Configure Server (UDP)** dialog box

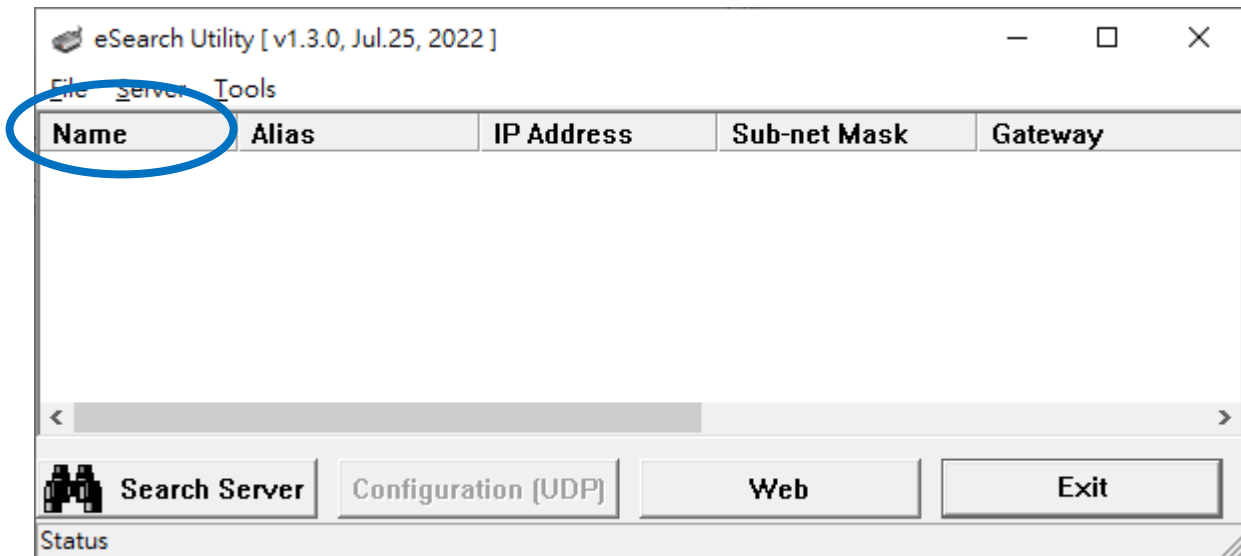

4. Enter the relevant values for the IP Address, Subnet Mask and Gateway, etc., and then click the **OK** button. The new settings for the iKAN display will take effect within 2 seconds.

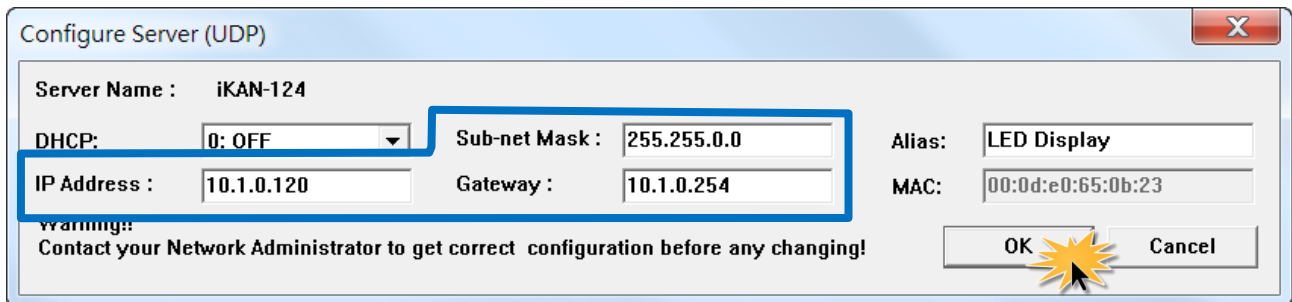



## 2.5. Editing Your First iKAN Message

A message can be configured using the built-in web interface. To edit your first message, follow the instructions given below.

1. Open a web browser such as Google Chrome, Firefox or IE, etc.
2. Type the IP address of the iKAN display in the address bar, and then press **Enter** to display the web interface

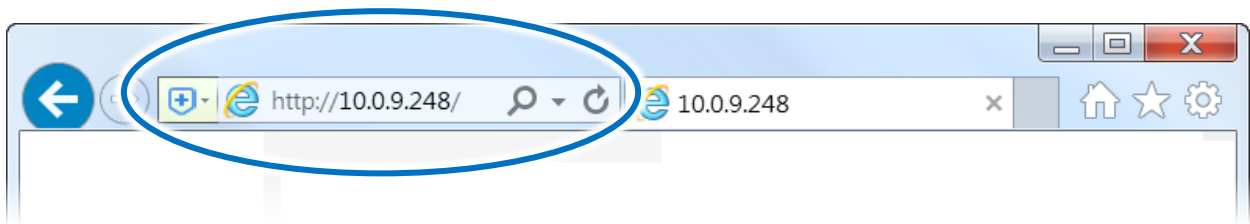

3. Select the language (English or Traditional Chinese) you wish to use by clicking the icon at the right hand side of the navigation bar at the top of the iKAN web interface.

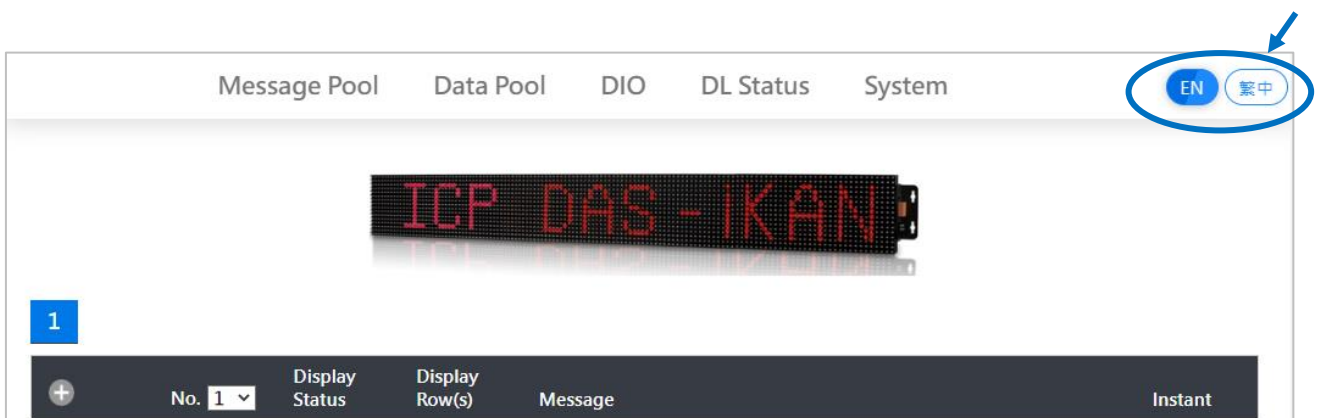

4. Click the **MESSAGE POOL** menu at the top of the page, select the message number you wish to add, and then click the  button

5. Click the  button

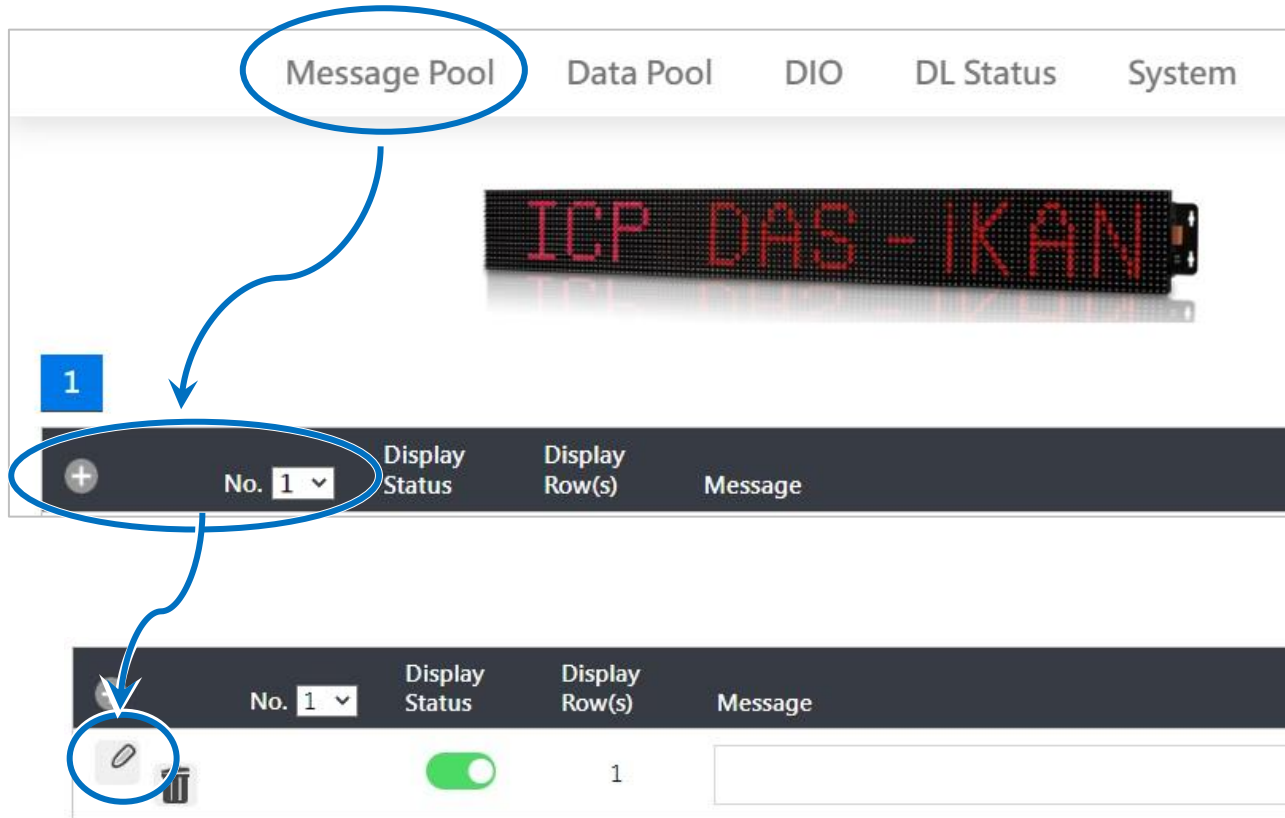

5. In the form for message **No. 1**, specify the following parameters:

- i. Check the **Display Status** checkbox
- ii. Select the desired color from the **Color** drop-down menu
- iii. Enter the following string in the **Message** text field:  
Hello World!
- iv. Click the **Update** button

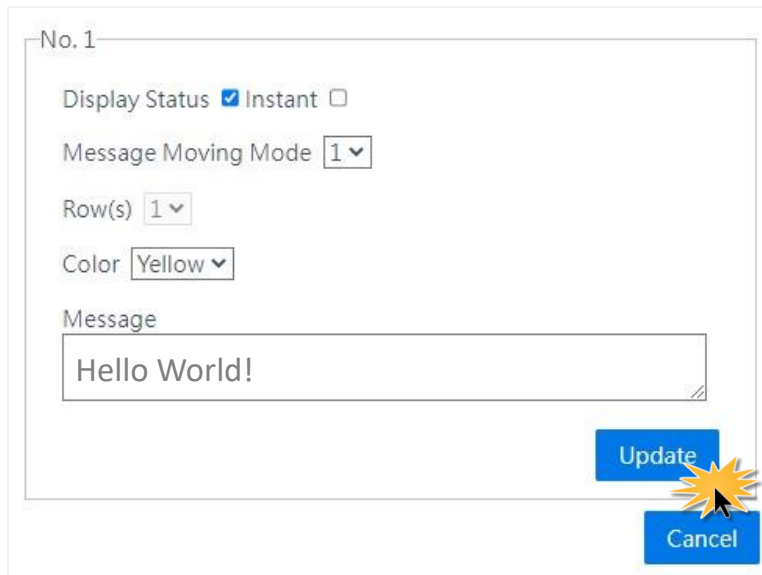

No. 1

Display Status  Instant

Message Moving Mode

Row(s)

Color

Message

6. The message will be shown on the display.

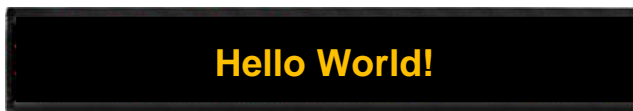

## 3. Configuration

---

The iKAN series device can be accessed and configured using a standard web-browser, such as Google Chrome, Firefox, or IE, etc., or Safari on a Mac, or via an Internet-enabled mobile device.

## 3.1. Web Interface

The iKAN display contains a built-in web interface that provides a range of functions needed to manage all messages displayed on the iKAN, as well as to set up the parameters, variables, and operational behavior. The majority of common operations can be carried out using the iKAN Web Interface.

The following is an overview of the major functions of the web interface, and provides a link to more information about the function.

Menu	Sub-Menu	This menu is used to	Refer to section
MESSAGE POOL	-	Allows you to edit and manage messages.	3.1.1 4.1 4.2
DATA POOL	INTEGER	Allows you to specify a value for a variable and define the data type mapping	3.1.2
	FLOAT		4.2
	COIL		4.3
DIO	-	Allows you to control the DO and read the status of DI/DO channels	3.1.5
DL Status	-	Allows you to get the information regarding connection status, real-time data and Modbus address for measured substance on the DL/CL series module.	3.1.4 5
SYSTEM	IMPORT/EXPORT	Allows you to import/export pre-configured messages and variables.	3.1.5 3.2.1
	ETHERNET	Allows you to set the network address and add DL/CL series modules connected via Ethernet.	3.1.5 3.2.2
	SERIAL PORT	Allows you to set the communication parameters for the serial port and add DL/CL series modules connected via RS-485.	3.1.5 3.2.3
	MISC.	Allows you to adjust the brightness, moving speed, or reset the device.	3.1.5 3.2.4

### 3.1.1. Editing and Managing Messages

A maximum of 128 messages with user-defined priority can be stored on the iKAN series device, and each message can contain a maximum of 20 Unicode characters or 50 ASCII characters. The contents of each message can be pre-configured individually via the MESSAGE POOL page on the web interface.

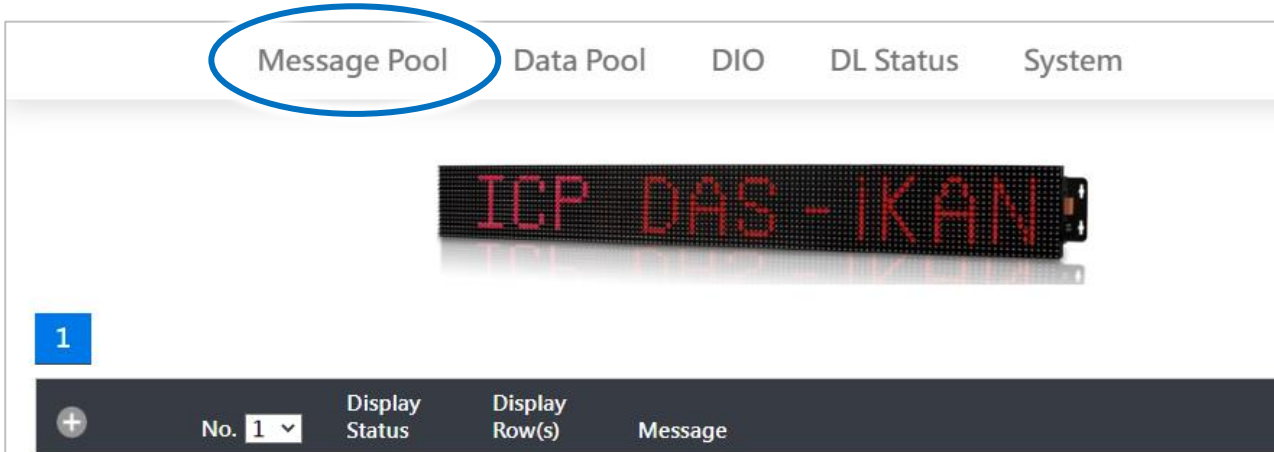

For more detailed information on how to edit and manage the messages displayed, refer to [Chapter 4. Messages](#)

### 3.1.2. Applying the Variable Maps

Variable maps provide a mechanism for mapping data to a variable regardless of the data source, and are listed on the DATA POOL page. The value of most variables can be individually specified via a variable map.

To specify a value for a variable, follow the instructions given below.

1. Click the **DATA POOL** menu item, and then click the item in the menu for the variable type you want to edit
2. Click the address of the variable you would like to configure.

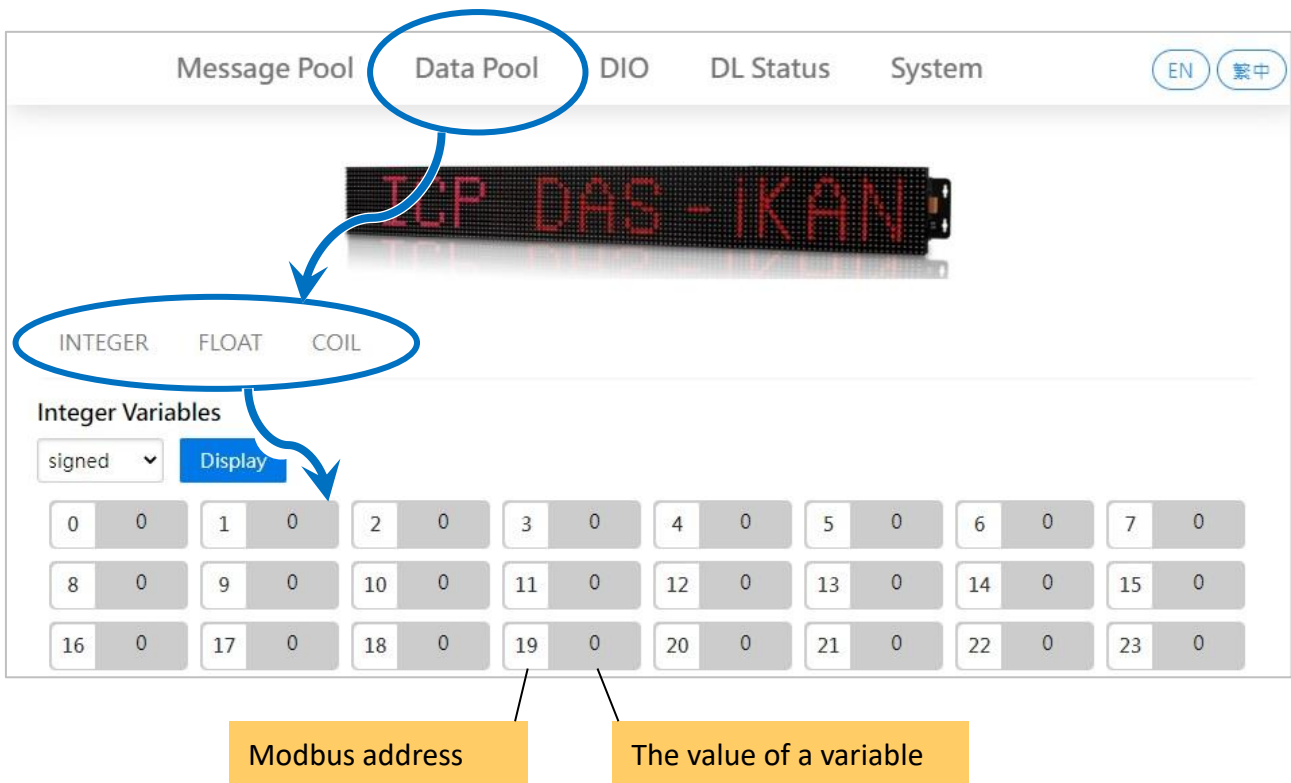

The configuration area will be registered depending on the selected address. The configuration area provides the following functions:

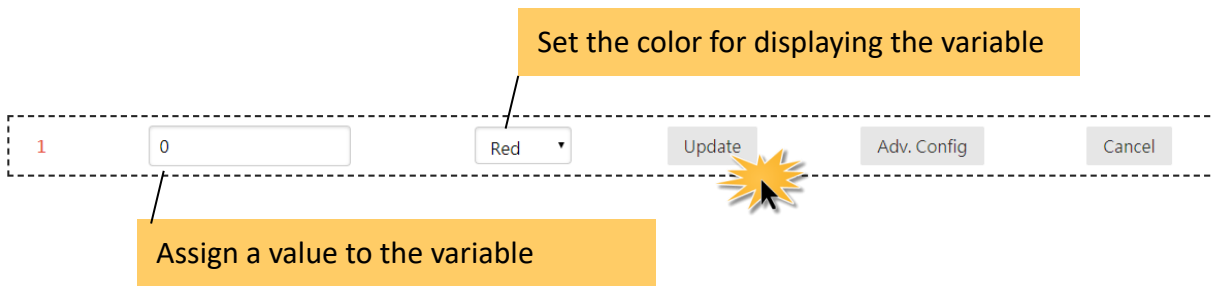

- **Assign a value to a variable**

In the text box, enter the relevant values for the selected variable, and then click the **Update** button

- **Specify the color of a variable displayed in the message**

From the drop-down menu, select the desired color for the variable, and then click the **Update** button

For more details about displaying values using a variable map, refer to [Section 4.3. Displaying a Value Applied using a Variable Map](#)



### 3.1.2.1. Mapping Physical Values to Integer-Type Variables

Most industrial measuring devices use 16-bit integers to convert a value from a data source to a real physical value, such as the voltage, temperature, or relative humidity. For example, using the range -32768 to 36767 to convert to -10V to +10V. The iKAN series device is able to perform data mapping to translate an integer value that has been read from a remote data source to a readable physical value.

For more detailed information on how to enable data mapping for the value of an integer-type variable, please refer to [Section 4.3.1. Displaying Mapping Data for Integer-type Variables](#)

### 3.1.2.2. Changing the Number of Decimal Places for the Value of a Float-type Variable

The number of decimal places to be displayed for a float-type variable can be set from the FLOAT VARIABLES page. Each variable contains two numbers as shown in the figure below. The first number is its Modbus address, and the second number is the value of a variable. For example, 128 in front of variable 0 indicates that the Modbus address for it is 40128, and 0.0 is its value.

Note that the address interval is 2, because each of float-type variables uses 2 registers.

For more detailed information about how to change the number of decimal places for the value of a float-type variable, refer to [Section 4.3.2. Displaying a Value with a Specific Number of Decimal Places for Float-type Variables](#)

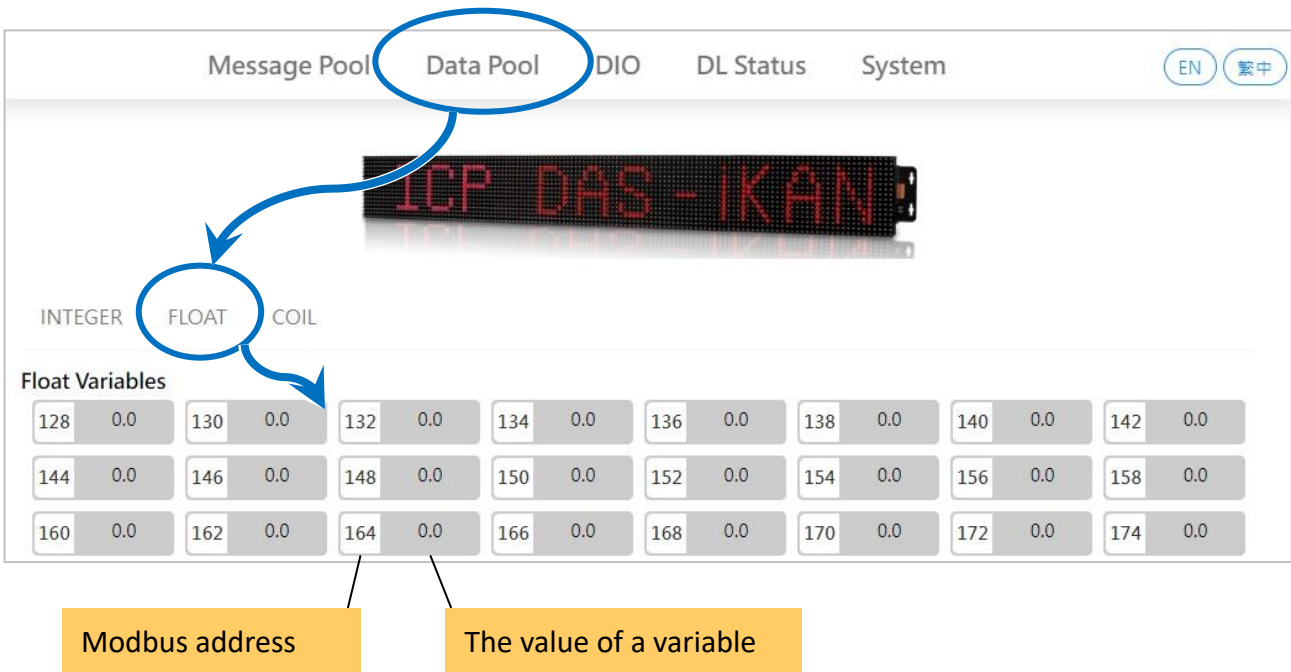

### 3.1.2.3. Assigning Strings to Coil Variables

iKAN series devices provide a string mapping function that allows the value of a coil variable to be mapped in order to make the coil value more meaningful when reading the message. The text mapping function allows a maximum of 10 Unicode characters or 30 ASCII characters to be entered to represent a value of 0 or 1.

For more detailed information about how to assign the replacement text for displaying the value of a coil variable, refer to [Section 4.3.3. Displaying the Value of a Coil Variable using Replacement Text](#)

### 3.1.3. DIO

iKAN series devices have two DI and two DO channels, the DI channels can be used to connect physical buttons or signals from devices in the field, as well as the DO channels can be used to connect sound and light alarm devices. If an emergency event occurs, the host in the control center can turn on alarm devices or read the status of button/switch connected to the iKAN device.

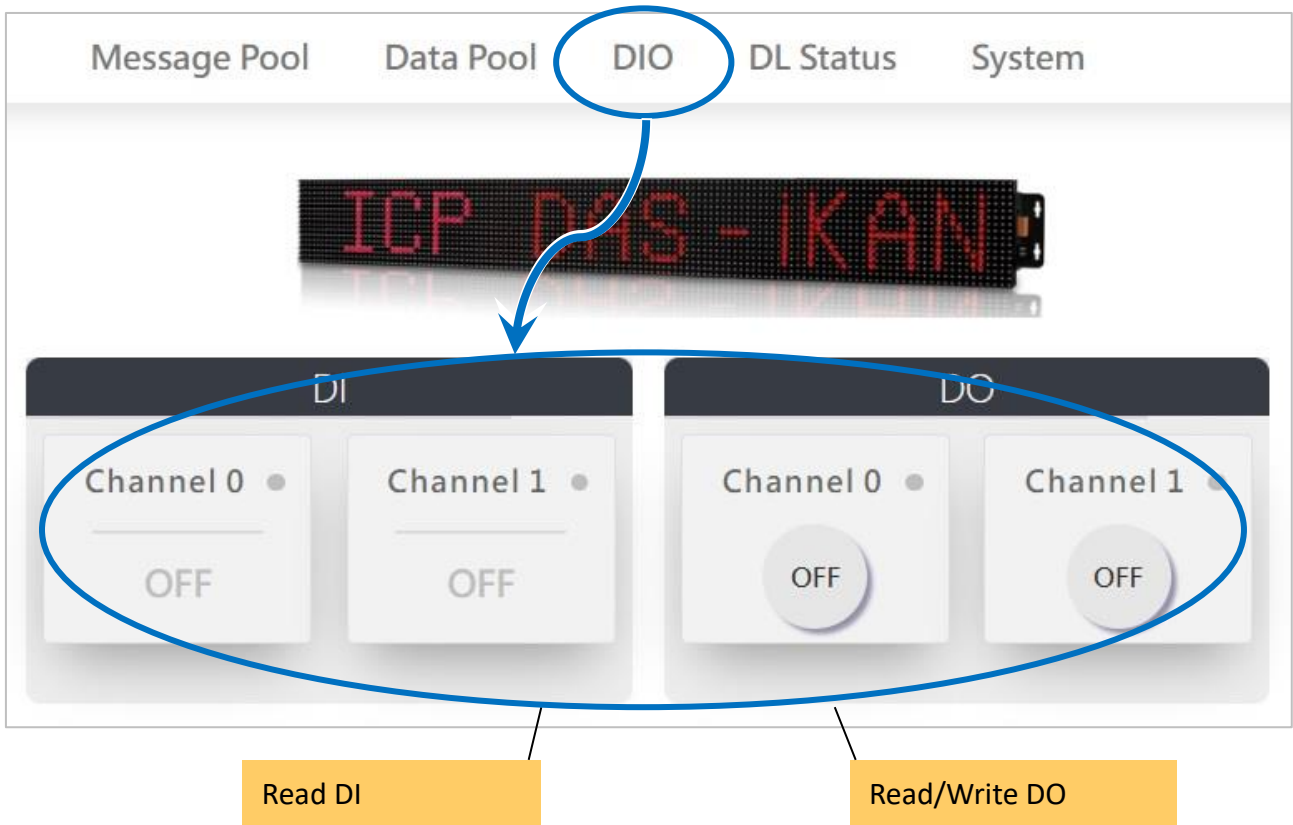

### 3.1.4. DL Status

iKAN series devices can directly connect with the DL/CL series air box modules via Ethernet or RS-485 interface without a host PC, obtain the real-time data from these modules, and refresh the data when it is displayed on the iKAN series device. Up to 8 DL/CL series modules can be connected via Ethernet, as well as up to 16 modules can be connected to each RS-485 port. That is to say, one iKAN display can connect up to 40 modules, and display the field measurement data in text message without a PC involved.

For more detailed information about how to set DL/CL series modules and how to display measured data in message, refer to [Section 5. Displaying Data from CL/DL series modules](#)

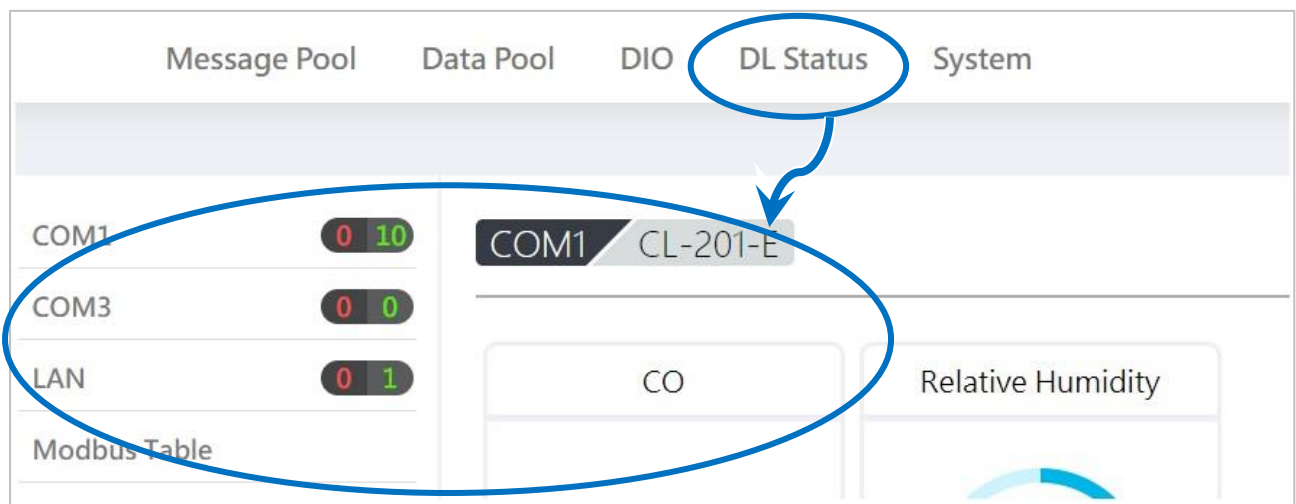

### 3.1.5. System

The System page provides a variety of settings including adjusting brightness and message moving speed, modifying system time, network or serial communication parameters, etc. All the setting steps are described in detail in [Section 3.2. System Configuration](#)

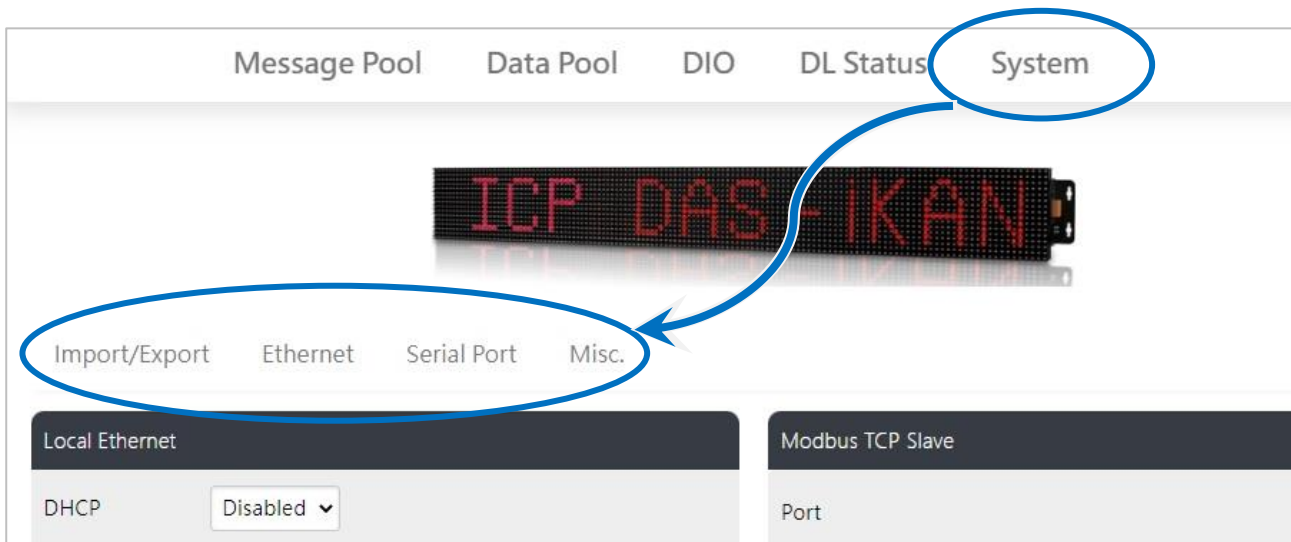

#### Import/Export

The contents of a message and/or variable can be exported to a CSV file, and then imported to other iKAN series devices. It is helpful to simplify and speed up the repetitive operations of setting up multiple devices.

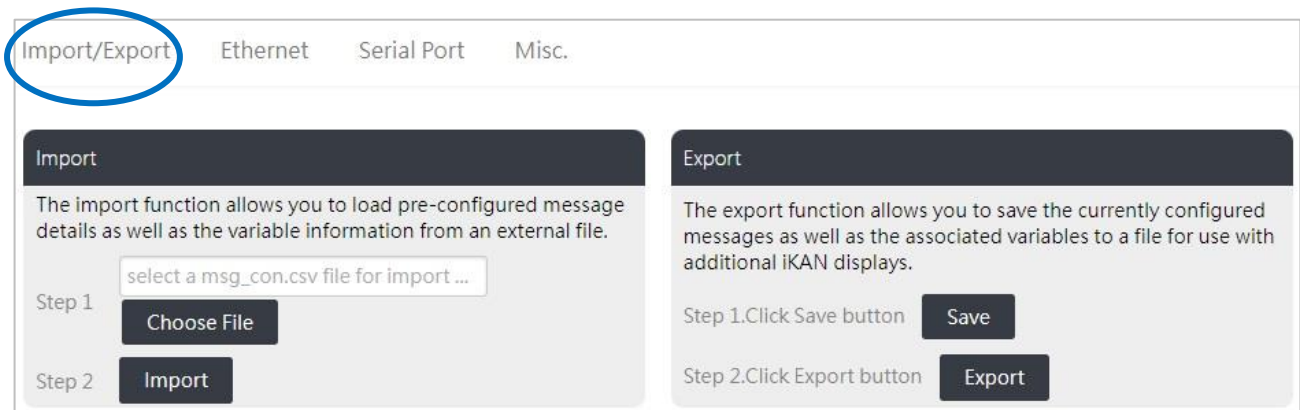

## ☑ Ethernet

The **Ethernet** page displays the current IP address, DHCP setting, Modbus TCP Slave and Master communication parameters. You can modify the communication parameters or add information for connecting DL/CL module linked on the Ethernet.

Import/Export **Ethernet** Serial Port Misc.

**Local Ethernet**

DHCP

IP Address  .  .  .

Mask  .  .  .

Gateway  .  .  .

**Modbus TCP Slave**

Port

NetID

**Modbus TCP Master**

## ☑ Serial Port

The **Serial Port** page displays the configuration for COM 1 and COM3. You can also add information for connecting DL/CL module connected to the RS-485 port for displaying measured data in text messages.

Import/Export Ethernet **Serial Port** Misc.

COM 1 COM 3

**Serial port > COM1**

Baud Rate

Data Bits

Stop Bit(s)

Parity

**Modbus RTU Master**

Mode

Timeout

Delay Between Polls

☑ **MISC**

The functions of setting the brightness, message moving speed and system time, restoring factory defaults and software reset are given on the **MISC** page.

Import/Export Ethernet Serial Port **Misc.**

### Misc.

LED Brightness

This function is used to set the LED brightness.

4 ▾ Update

Message Moving Speed

This function is used to set the message moving speed.

1 ▾ Update

Delay Between Message Switch (second)

4 Update

Update Date & Time

Time Duplication ▾

This function is used to reset the RTC on the module, based on the current date and time of the local machine. Update

Time Synchronization Setting ▾

Function Status

SNTP Time Server pool.ntp.org time.windows.com time.nist.gov

Use Default SNTP Time Servers

Sync Interval 12 Hours ▾

Time Zone (UTC+08:00) ▾

Update

Restore the default settings



## 3.2. System Configuration

---

The following sections describe the details of the configuration items on the System page.

### 3.2.1. Exporting pre-configured messages

If your system includes more than one iKAN series device, it could take a lot of time to individually configure each one. To simplify this process, the Import/Export function can be used to pre-configure the contents of a message or variable on the iKAN series device before using Modbus TCP/RTU commands to manage the message pool, thereby reducing the need to repeat the configuration tasks multiple times.

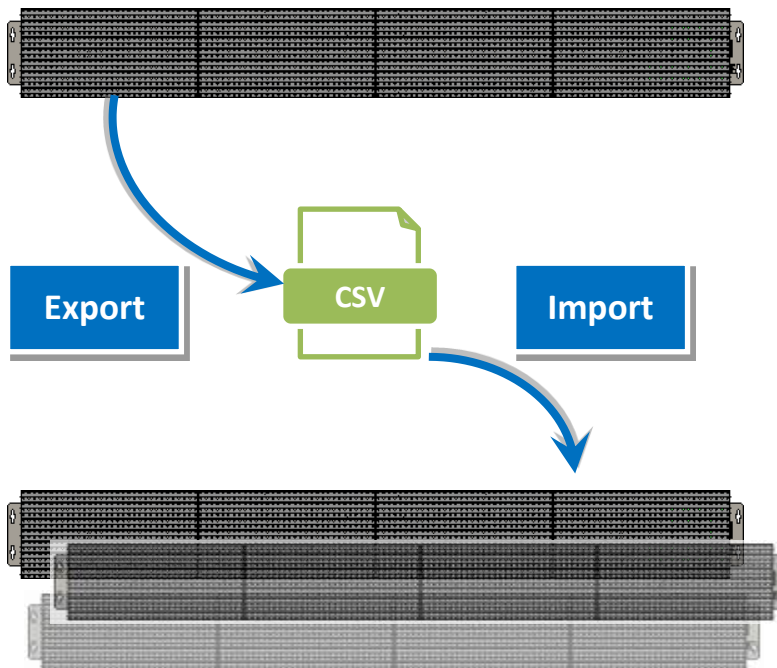

## ☑ Importing a configuration file

The contents of a messages, variables and configuration for CL/DL series modules can be imported from a CSV file. The following is a description of how to import a previously stored configuration file. Note that the Import function will only load configuration information related to messages, variables and configuration for CL/DL series modules.

1. Click the **SYSTEM** menu item, and then click the **IMPORT/EXPORT** menu item
2. Click the **Choose File** button to select the desired CSV file, and then click the **Import** button to load the contents of the configuration file into the system

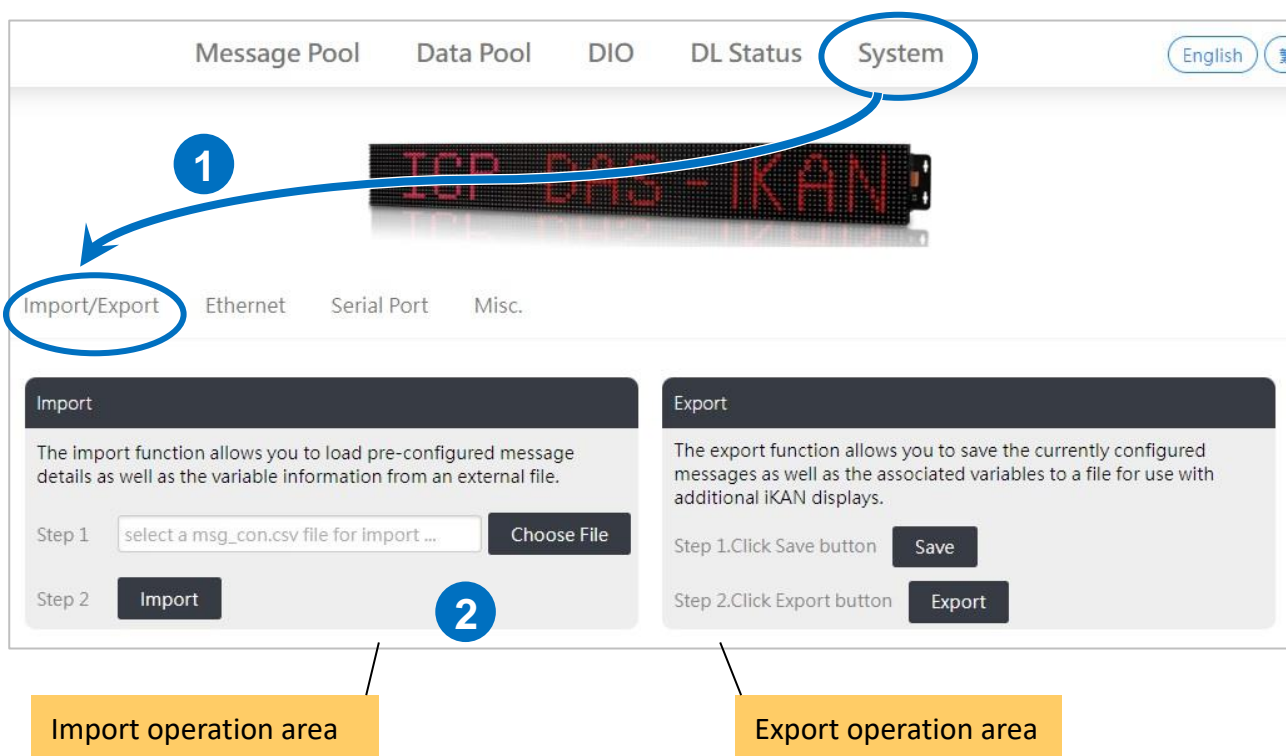

## ☑ Exporting a configuration file

The contents of messages, variables and configuration for CL/DL series modules can be exported as a CSV file. The default file name is msg\_con.csv, which can be changed to a preferred file name if desired.

1. Click the **SYSTEM** menu item, and then click the **IMPORT/EXPORT** menu item
2. Click the **Save** button to save the configuration, and then click the **Export** button to export configuration to the msg\_con.csv file in the default download location in your browser.

The screenshot displays the control interface for an iKAN Series Display. At the top, there are menu items: Message Pool, Data Pool, DIO, DL Status, and System. The System menu is circled in blue. Below the menu items, there is a display showing the text "ICP DAS - IKAN". Below the display, there are sub-menus: Import/Export, Ethernet, Serial Port, and Misc. The Import/Export menu is circled in blue. Below the sub-menus, there are two panels: Import and Export. The Import panel has a text input field "select a msg\_con.csv file for import ..." and a "Choose File" button. The Export panel has a "Save" button and an "Export" button. A blue arrow labeled "1" points from the System menu to the Import/Export menu. A blue circle labeled "2" is next to the Save and Export buttons. Below the Import panel, there is a yellow box labeled "Import operation area". Below the Export panel, there is a yellow box labeled "Export operation area".

The content of the msg\_con.csv is encoded, so you cannot modify it in text editor or Excel. Once the file is imported into another iKAN device, the configuration for messages, variables and CL/DL series modules will automatically be applied to the new one.

	A	B	C	D	E	F	G	H	I	J	K
1	iKAN LED Display Pre-Configuration file										
2	1	1	1	1	1	1	0	0	0	0	0
3	1	1	1	1	1	1	0	0	0	0	0
4	1	1	1	1	1	0	0	0	0	0	0
5	1	1	1	1	1	0	0	0	0	0	0
6	1	1	1	1	1	1	1	1	1	1	1
7	6	6	6	6	6	6	0	0	0	0	0
8	0	0	0	0	0	0	0	0	0	0	0
9	0	0	0	0	0	0	0	0	0	0	0
10	0	0	0	0	0	0	0	0	0	0	0
11	0	0	0	0	0	0	0	0	0	0	0
12	0	0	0	0	0	0	0	0	0	0	0
13	0	0	0	0	0	0	0	0	0	0	0

## 3.2.2. Ethernet Configuration

### ☑ Changing the IP Address

The IP address for the iKAN device can be changed if necessary. To change the IP address, follow the instructions given below.

1. Click the **System** menu item, and then click the **Ethernet** menu item
2. Enter the IP address for the iKAN device in the relevant fields
3. Click the **Update Settings** button to save your changes.

The screenshot shows the configuration interface for the iKAN device. At the top, there are menu items: Message Pool, Data Pool, DIO, DL Status, and System. The System menu is circled in blue with a '1' and an arrow pointing to the Ethernet menu item. The Ethernet menu item is also circled in blue with a '1'. Below the menu items, there is a section for Local Ethernet configuration. This section is highlighted with a blue box and a '2'. It contains fields for DHCP (Disabled), IP Address (10.0.30.182), Mask (255.255.255.0), Gateway (10.0.30.254), and DNS (8.8.8.8). Below the Local Ethernet section, there is a button labeled 'Update Settings' circled in blue with a '3' and a starburst icon. To the right of the Local Ethernet section, there are sections for Modbus TCP Slave and Modbus TCP Master. The Modbus TCP Slave section has fields for Port (502) and NetID (1). The Modbus TCP Master section has a dropdown menu for 'Connect to DL series module' and fields for Timeout (2000) and Delay Between Polls (2000).

### Tips & Warnings



If the NTP time synchronization is enabled, it is necessary to specify a DNS server for resolving the domain name and getting the IP address of NTP server.

☑ **Setting NetID and Port number for Modbus TCP communication**

1. Enter the port number or NetID in the relevant fields.
2. Click the **Update Settings** button to save your changes.

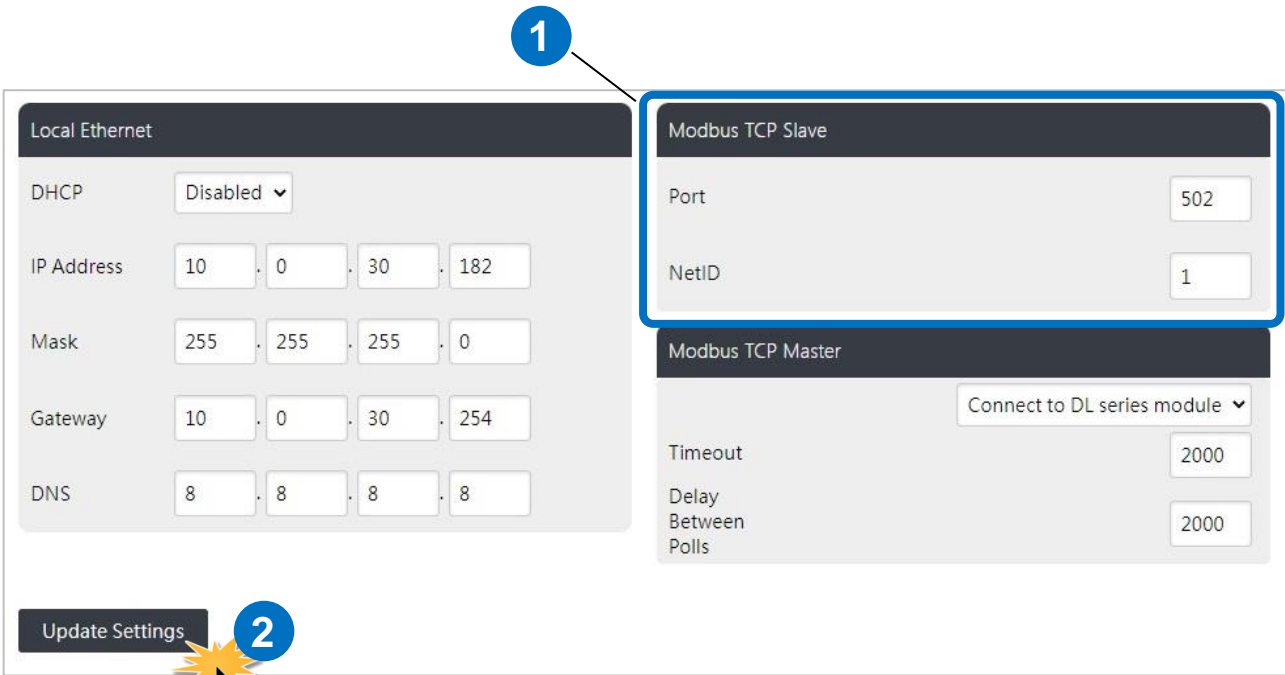

☑ **Adding information for DL/CL series modules connected to the network**

For more detailed description, please refer to [Section 5.1. Displaying Data from CL/DL Modules Connected to Ethernet](#)

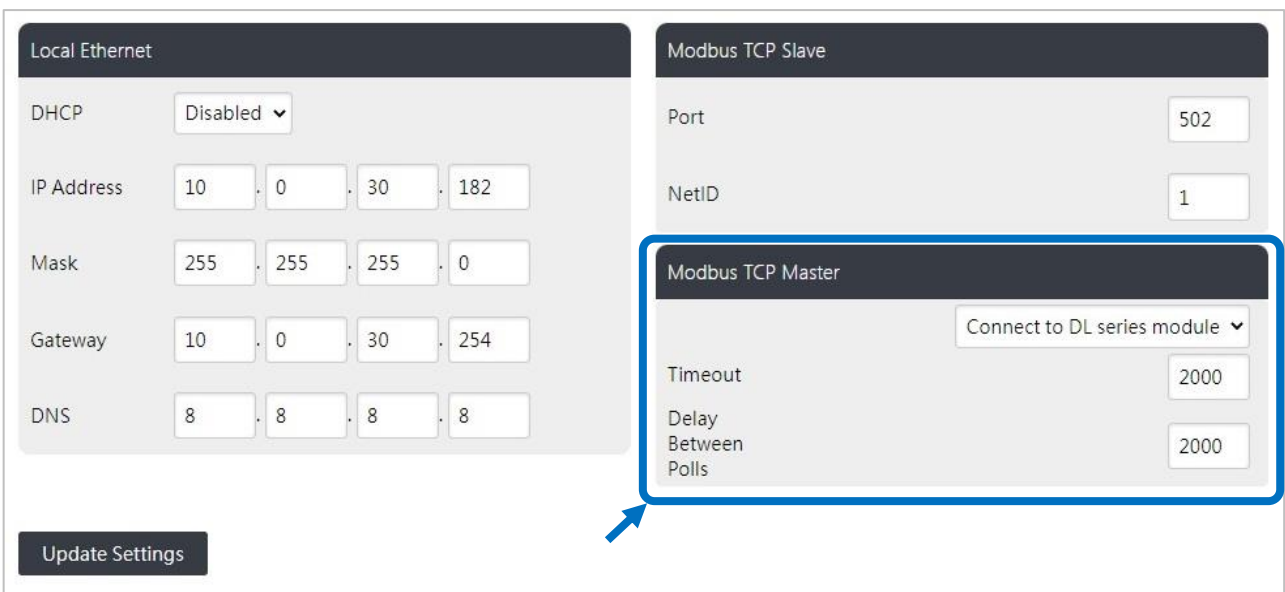

### 3.2.3. Serial Port Configuration

The two RS-485 serial ports on the iKAN display can be used to connect to a PC, a PLC or CL/DL series modules. It allows the PC or PLC to control the message display using Modbus RTU protocol. Alternatively, connect to the DL/CL series modules series modules for displaying measured data in text messages, without the intervention of a host PC.

The default parameters are:

Baud Rate: 115200  
Data Bits: 8  
Stop Bit(s): 1  
Parity: None

The screenshot shows a configuration window with tabs for 'Import/Export', 'Ethernet', 'Serial Port', and 'Misc.'. The 'Serial Port' tab is selected and circled in blue. At the top right of the configuration area, 'COM 1' and 'COM 3' are visible. The main configuration area is divided into two panels: 'Serial port > COM1' and 'Modbus RTU Master'. The 'Serial port > COM1' panel contains four input fields: 'Baud Rate' (115200), 'Data Bits' (8), 'Stop Bit(s)' (1), and 'Parity' (None). The 'Modbus RTU Master' panel contains three input fields: 'Mode' (Connect to DL series modules), 'Timeout' (300), and 'Delay Between Polls' (200). A 'Save Settings' button is located at the bottom left of the configuration area.

## ☑ **Configuring the serial port**

1. Click the COM Port to be configured on the upper right corner of the Serial Port page,.
2. Configure the relevant parameters for the serial port.
3. Click the **Save Settings** button to complete the process

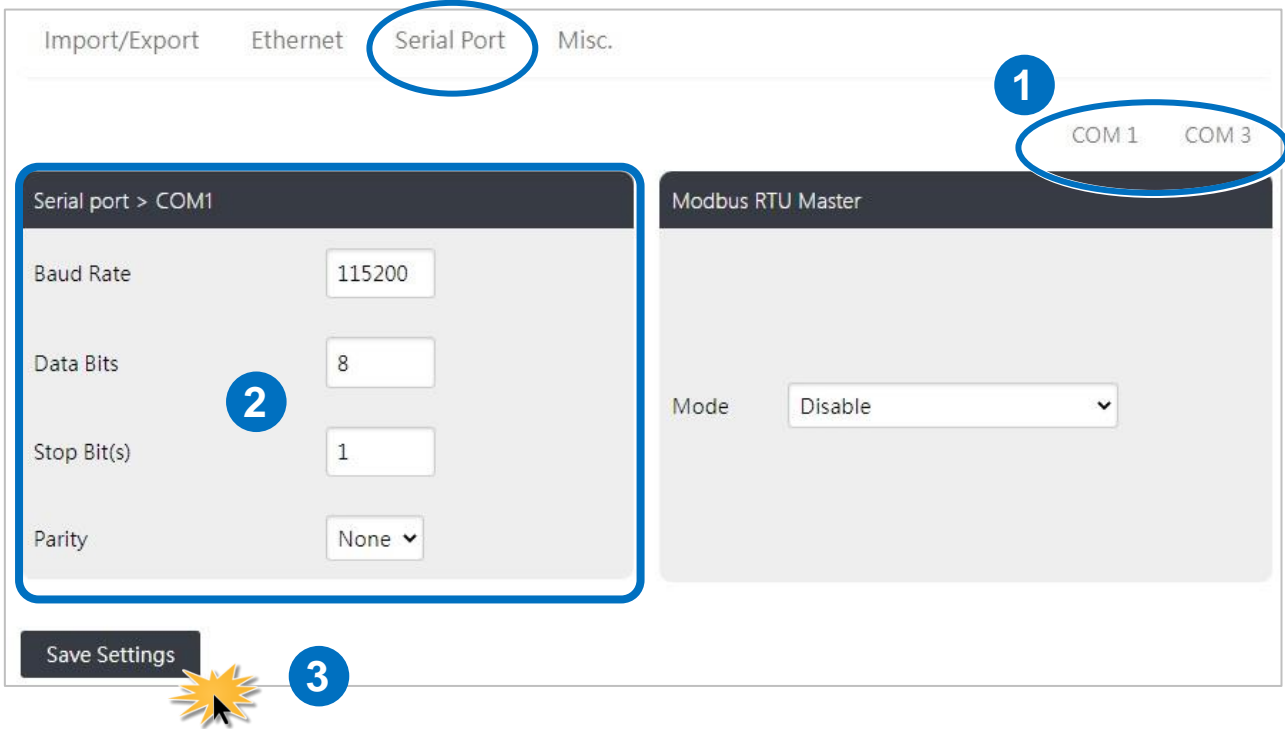

## ☑ **Adding information for DL/CL series modules connected to the RS-485 port**

For more detailed description, please refer to [Section 5.2. Displaying Data from CL/DL Modules Connected to RS-485](#)

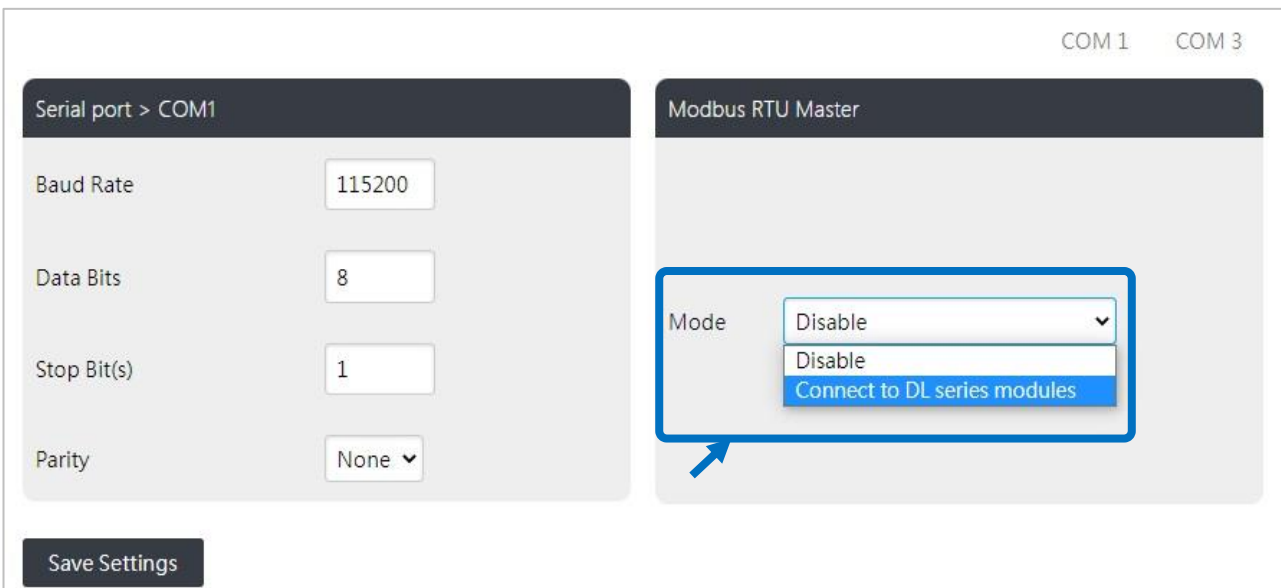



### 3.2.4. MISC

The functions of setting the brightness, message moving speed and system time, restoring factory defaults and software reset are given on the MISC page.

The screenshot displays the 'MISC' configuration page. At the top, navigation tabs include 'Message Pool', 'Data Pool', 'DIO', 'DL Status', and 'System' (circled in blue). Below these is a red LED display showing 'ICP DAS iKAN'. A blue arrow points from the 'System' tab to the 'Misc.' tab, which is also circled in blue. The 'Misc.' section contains several settings:

- Misc.**
- LED Brightness**: This function is used to set the LED brightness. Value: 4.
- Message Moving Speed**: This function is used to set the message moving speed. Value: 1.
- Delay Between Message Switch (second)**: Value: 4.
- Update Date & Time**: Time Duplication. This function is used to reset the RTC on the module, based on the current date and time of the local machine.
- Time Synchronization Setting**: Function Status: . SNTP Time Servers: pool.ntp.org, time.windows.com, time.nist.gov. . Sync Interval: 12 Hours. Time Zone: (UTC+08:00).
- Restore the default settings**: This function allows you to restore the configuration of the module to the factory default values.

## ✓ Adjusting the Brightness and Motion Speed

There are 5 levels of brightness and 10 levels of message motion speed on the iKAN display. Higher values indicate a brighter setting for the LED, as well as a slower scrolling speed. To adjust the parameters for displaying messages, follow the instructions given below.

LED Brightness

This function is used to set the LED brightness.

4 ▾ Update

---

Message Moving Speed

This function is used to set the message moving speed.

1 ▾ Update

---

Delay Between Message Switch (second)

4 Update

Item	Description
LED Brightness	<ol style="list-style-type: none"><li>1. Select a value from the <b>LED Brightness</b> drop-down menu. Higher values indicate a brighter setting for the display.</li><li>2. Click the <b>Update</b> button to save your changes</li></ol>
Message Moving Speed	<ol style="list-style-type: none"><li>1. Select a value from the <b>Message Moving Speed</b> drop-down menu. Lower values indicate a higher scrolling speed.</li><li>2. Click the <b>Update</b> button to save your changes</li></ol>
Delay Between Message Switch (second)	<ol style="list-style-type: none"><li>1. Enter the delay time for message switch in the text box of <b>Delay Between Message Switch (second)</b>. The range of valid values is 1 to 32 (s).</li><li>2. Click the <b>Update</b> button to save your changes</li></ol>

## ☑ Updating Date and Time

The iKAN device has a built-in real-time clock (RTC), which can be applied to display the accurate time in the message, and supports NTP for clock synchronization. You can specify the domain name of a NTP server, and the synchronization period here.

1. Before enabling the NTP function, you need to go to the **Ethernet** page to set a DNS server IP address. Then click the **Update Settings** button to complete the settings.

Import/Export **Ethernet** Serial Port Misc.

**Local Ethernet**

DHCP Disabled

IP Address 10 . 0 . 30 . 182

Mask 255 . 255 . 255 . 0

Gateway 10 . 0 . 30 . 254

DNS 8 . 8 . 8 . 8

**Modbus TCP Slave**

Port 502

NetID 1

**Modbus TCP Master**

Connect to DL series module

Timeout 2000

Delay Between Polls 2000

Update Settings

- Slide the button next to Function Status to the right (turn green) in the **Update Data & Time** field on the **MISC** page to enable the Time Synchronization function. Enter the domain name of the NTP server; select the synchronization interval and Time Zone from the respective drop-down menus. Then click the **Update** button to complete the setup.

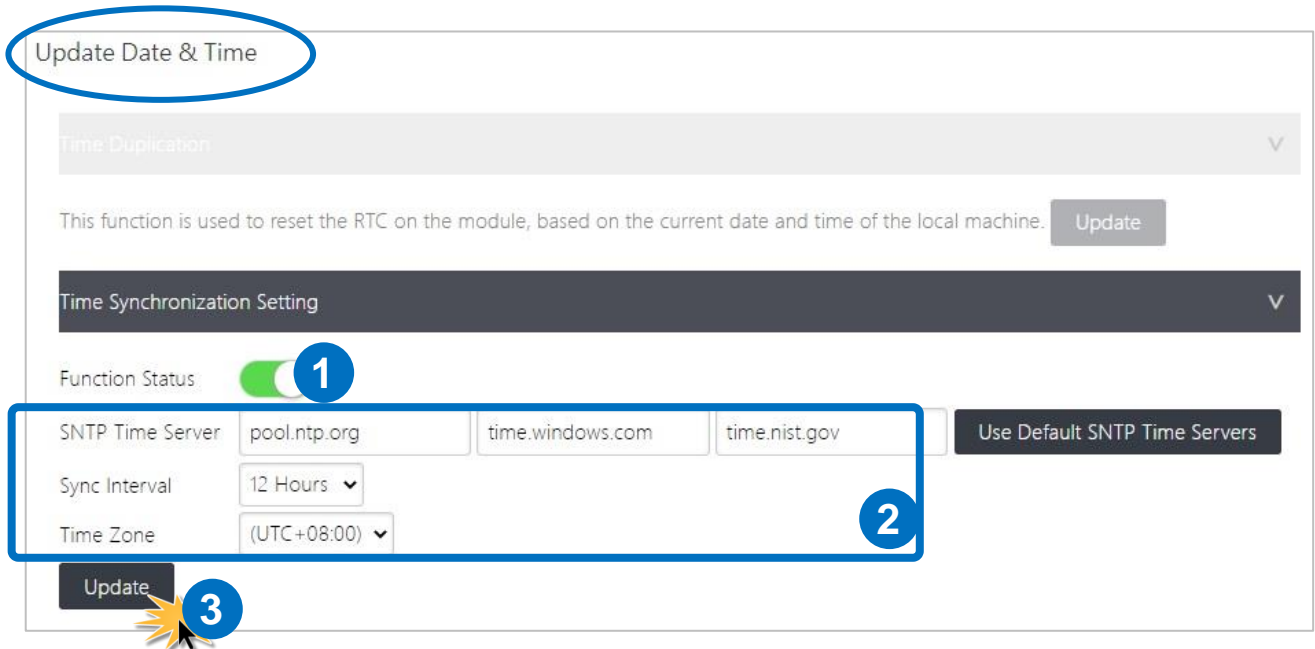

### Synchronizing Date and Time with PC

You can also synchronize the date and time values on the iKAN display with those on the PC. To synchronize the date and time values with the PC, follow the instructions given below.

- Slide the button next to **Function Status** to the left.
- Click the **Update** button. The date and time values will then be synchronized with the PC.

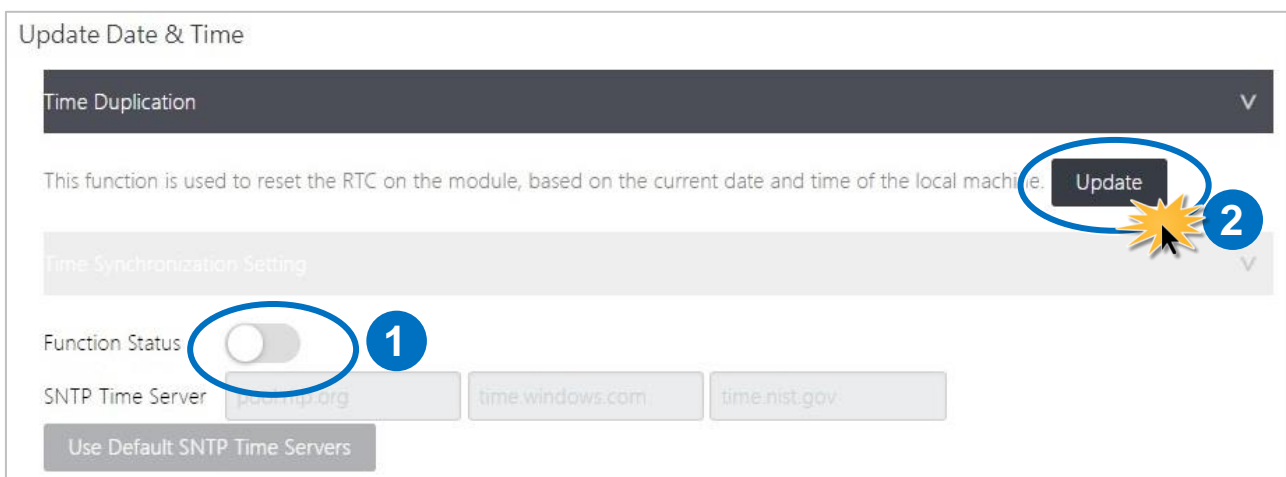

## ☑ Restoring the Default Settings

This function provides the ability to perform a safe reset for the iKAN display. All messages and variable configuration settings will be reset to the factory defaults. To restore the default settings, follow the instructions given below.

1. Scroll down the MISC page to see the **Restore the default setting** section.
2. Click the **Restore** button to complete the setting.



## ☑ Resetting the Display

This function provides a safe reset option for the iKAN display. To reset the display, follow the instructions given below.

1. Scroll down the MISC page to see the **Software Reset** section.
2. Click the **Reset** button to complete the setting.



## Viewing the Module Name and Firmware Version

The module name and firmware version are located at the bottom of the MISC page. You can confirm the firmware version here if you need to update the firmware.

Module Name
iKAN-124
Firmware Version
3.0.1

### 3.3. eSearch Utility

---

The eSearch utility is an application specifically designed for use with products embedded with the ICP DAS MiniOS7 operating system. It has been developed so that you can search for ICP DAS Ethernet I/O modules which are connected to the same subnetwork as the Host PC, configuring the Ethernet parameters, such as IP address, subnet mask and gateway etc., or updating firmware.



The eSearch Utility can be obtained from:

<https://www.icpdas.com/en/download/index.php?nation=TW&kw=esearch>

Default Installation Path

C:\ICPDAS\eSearch

### 3.3.1. Configuring the IP Address

The IP address can be changed using the eSearch utility. To change the IP address, follow the instructions given below.

1. Launch the **eSearch utility** and click the **Search Server** button

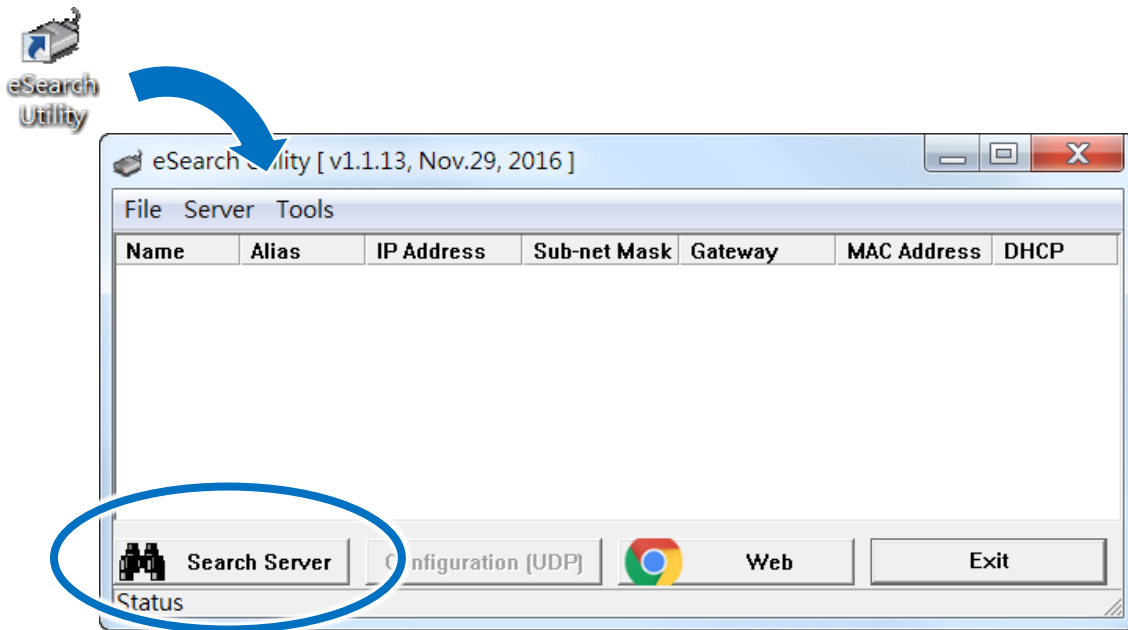

2. Once the search process has completed, double-click the name of iKAN display to open the **Configure Server (UDP)** dialog box

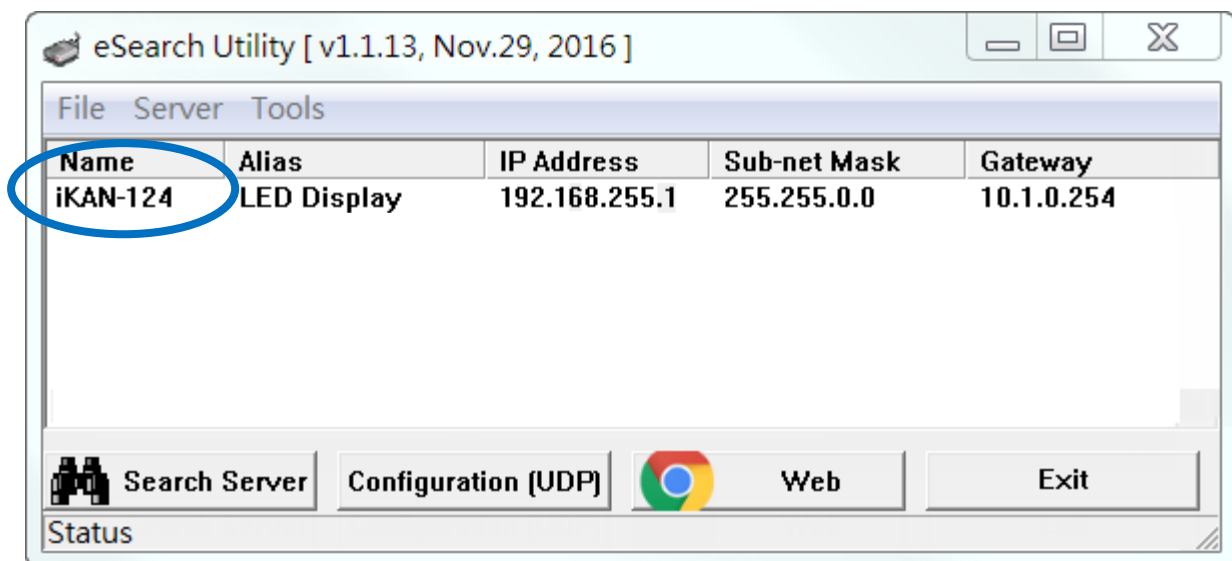



3. Enter the relevant values for the IP Address, Subnet Mask and Gateway, etc., and then click the **OK** button. The new settings for the iKAN display will take effect within 2 seconds.

Configure Server (UDP)

Server Name : iKAN-124

DHCP: 0: OFF      Sub-net Mask : 255.255.0.0      Alias: LED Display

IP Address : 10.1.0.120      Gateway : 10.1.0.254      MAC: 00:0d:e0:65:0b:23

Warning!!  
Contact your Network Administrator to get correct configuration before any changing!

OK      Cancel

### 3.3.2. Sending the Modbus Command to iKAN

The eSearch Utility includes two embedded configuration tools, the Modbus RTU Master and the Modbus TCP Master, which can be used to send Modbus commands to the iKAN display.

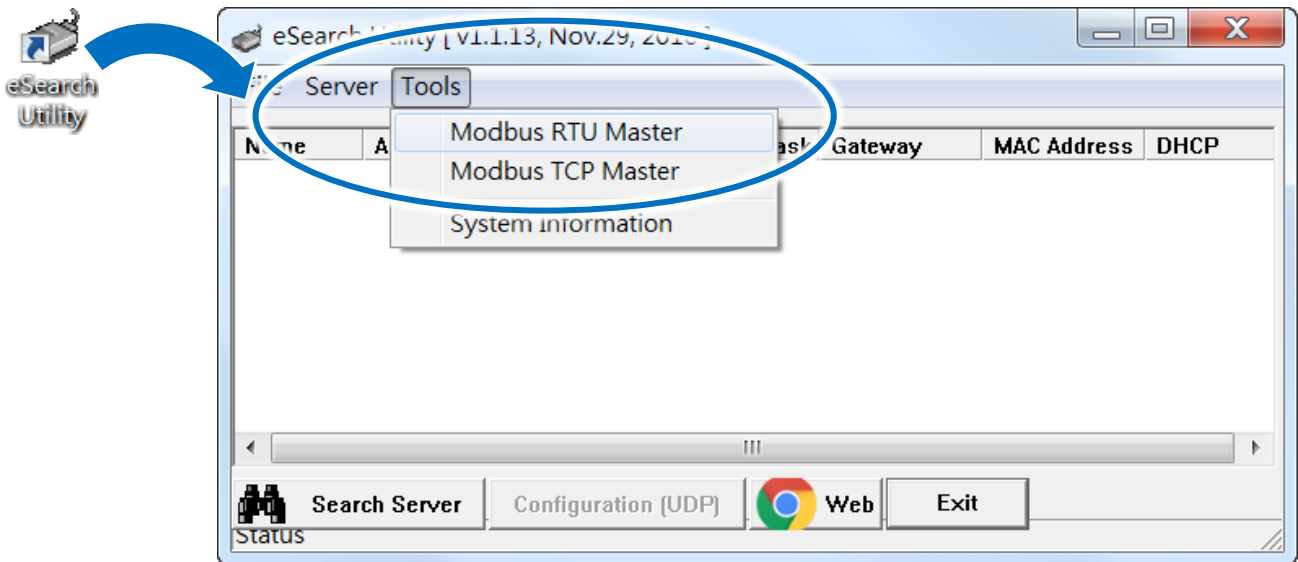

The **Modbus RTU Master** tool can be used to send a Modbus message to either read or write I/O values via the COM port.



The **Modbus TCP Master** tool can be used to send a Modbus message to either read or write I/O values via the Ethernet.



### 3.3.2.1. Sending Modbus RTU Command to the iKAN Display

1. Select the **Modbus RTU Master** option from the **Tools** menu
2. Select the COM Port and Baud Rate from the respective drop-down menus, and then click the **Open** button

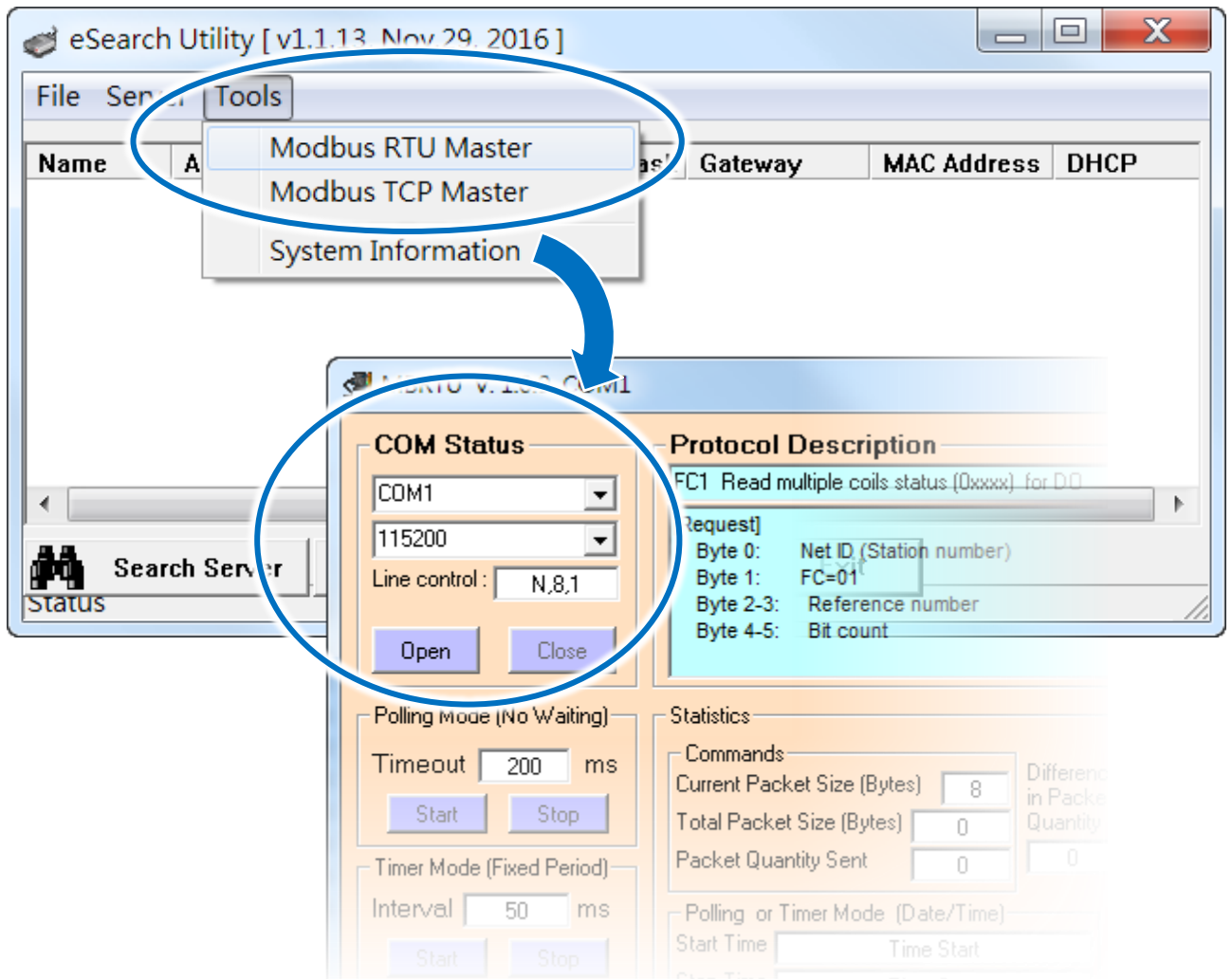

3. Enter a command in the command line field and then click the **Send Command** button to transmit the command

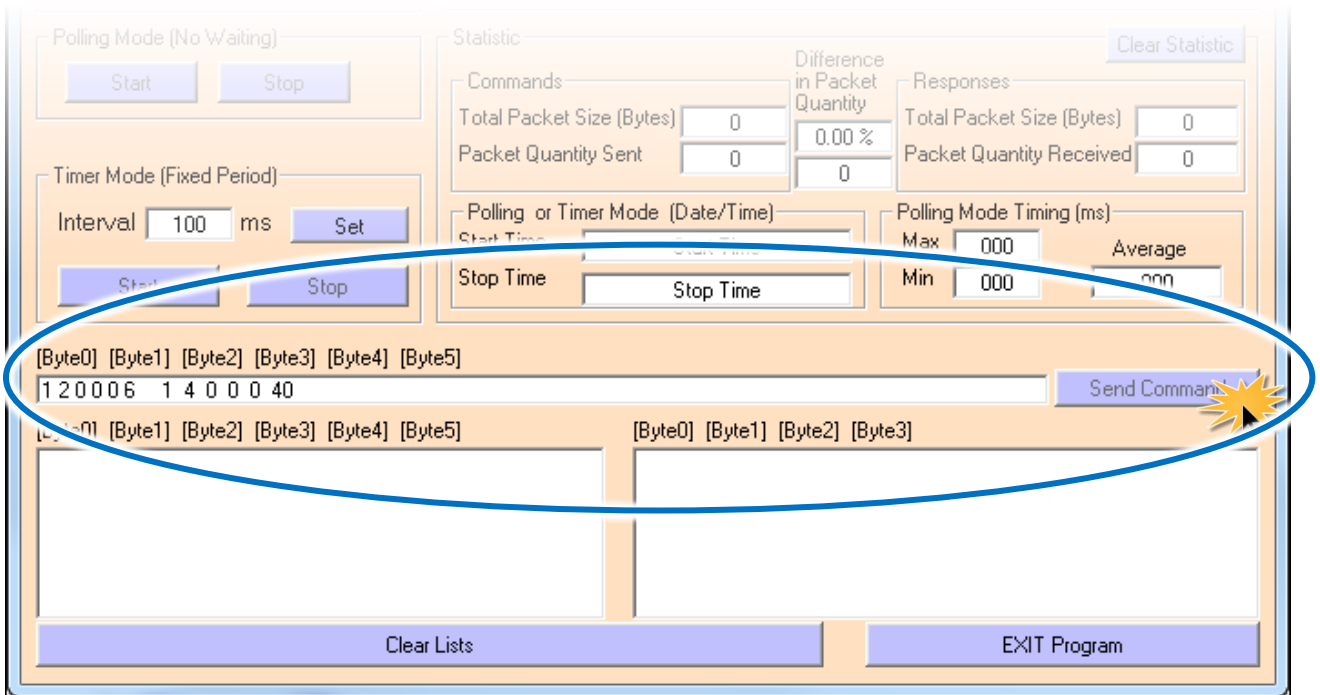

4. The command will be displayed on the left-hand side of the text box area, and the response will be shown on the right-hand side

### 3.3.2.2. Send Modbus TCP Command to the iKAN display

1. Select the **Modbus TCP Master** option from the **Tools** menu
2. Enter the IP address and the Port number in the respective text fields and then click the **Connect** button

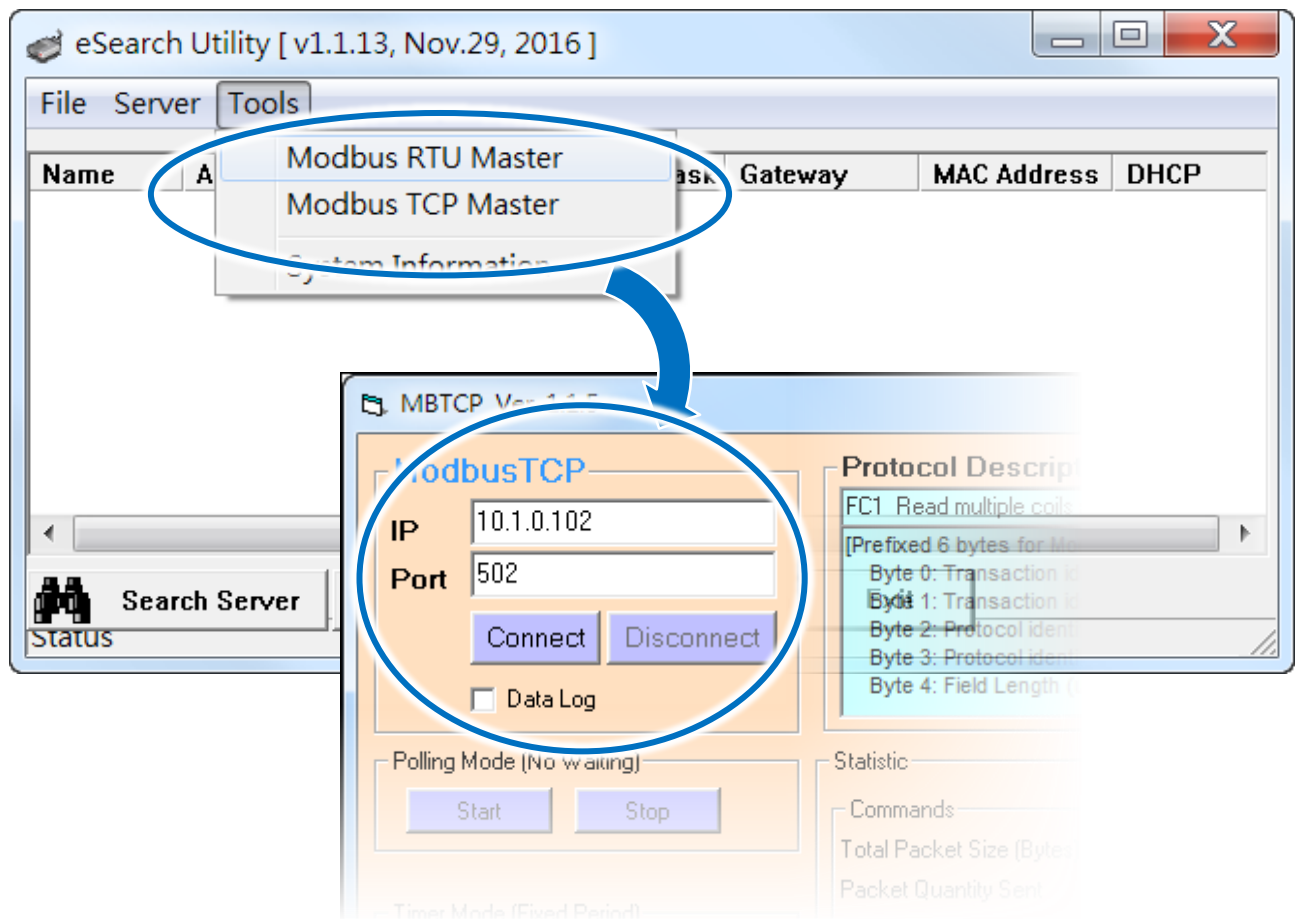

3. Enter a command in the command line field and then click the **Send Command** button to transmit the command

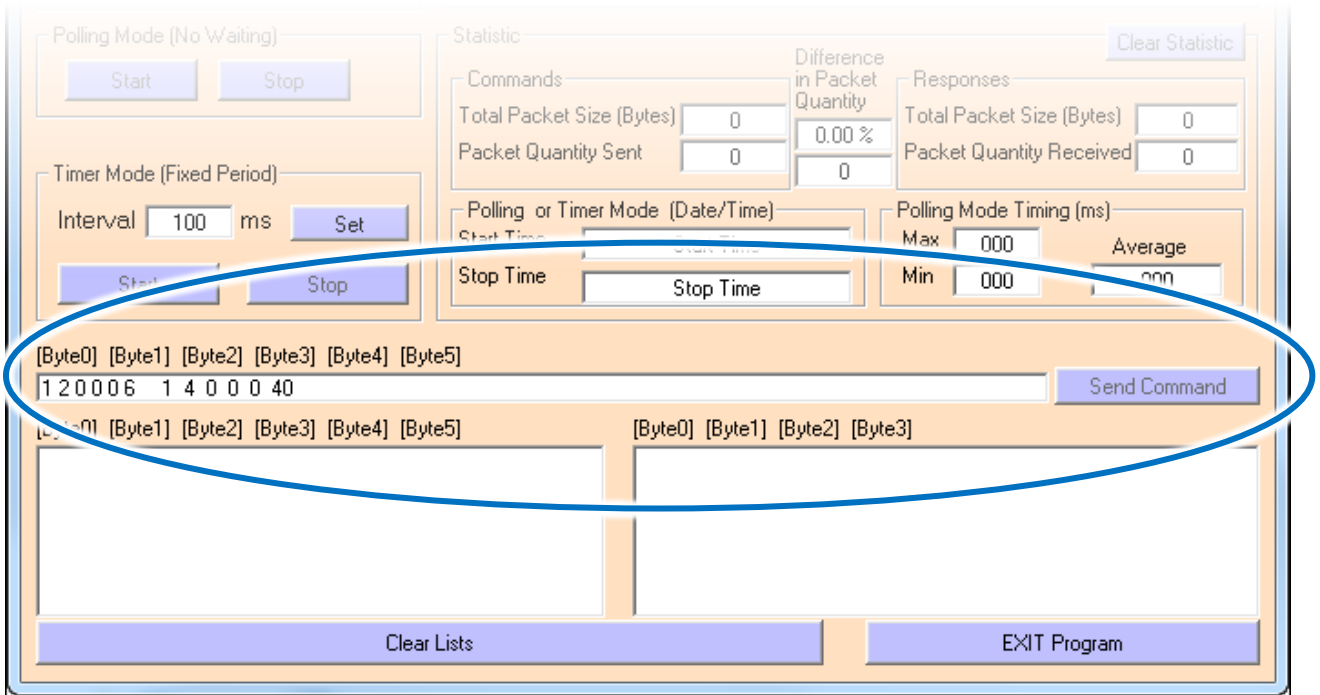

4. The command will be displayed on the left-hand side of the text box area, and the response will be shown on the right-hand side

## 4. Messages

The iKAN web configuration interface provides a convenient and simple method to easily manage the message contents and its effects.

A maximum of 128 messages with user-defined priority can be stored on the iKAN series device, and each message can contain a maximum of 20 Unicode characters or 50 ASCII characters.

### 4.1. Editing and Managing Messages

The contents of each common message or instant message can be individually pre-configured via the **MESSAGE POOL** page on the web interface.

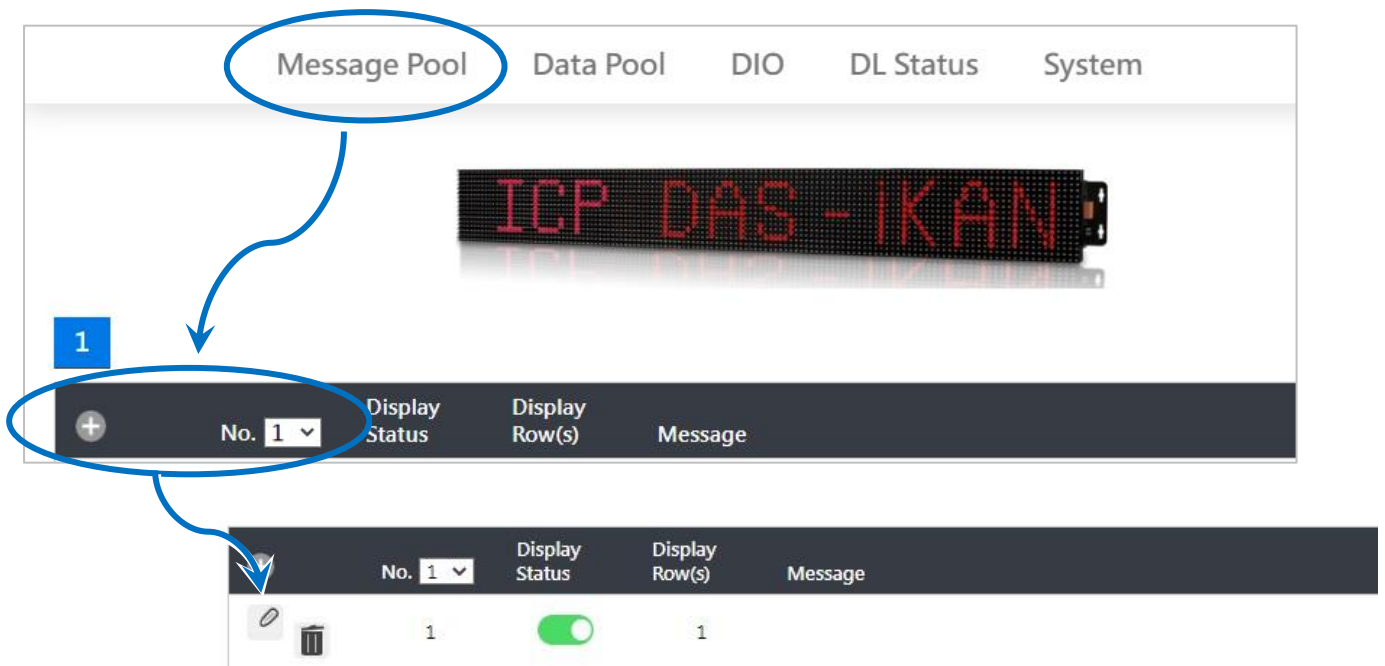

Select the number of the message that you would like to add, and then click the  button. The message item will be added to the message queue.



There are two buttons for each message item.



The  button is used to edit the message.

The  button is used to delete the message.

	No.	Display Status	Display Row(s)	Message
 	1	<input checked="" type="checkbox"/>	1	

By default, any message that is added has no effect until you add parameters to the message form.

Click the  button to enter the message form.

	No.	Display Status	Display Row(s)	Message
 	1	<input checked="" type="checkbox"/>	1	

No. 1

Display Status  Instant

Message Moving Mode

Row(s)

Color

Message



The following is a summary of the items contained in the message form:

Item	Function
Display Status	Check this checkbox to enable the contents of the message to be displayed on the iKAN series device.
Instant	Check this checkbox to set this message as an instant message.
Message Moving Mode	Select a value from the drop-down menu to specify the message moving mode. 0: Display a message statically 1: Scroll a message when the message length exceeds the maximum character length within a line of iKAN, otherwise, hold the message statically. 2: Hold the message on the first line and scroll the message on the second line. (For two-line model only) 3: Display one scrolling message in two lines on the iKAN device, when the message length exceeds the maximum character length within a line of iKAN. (For two-line model only)
Row(s)	Select a value from the drop-down menu to specify the row where the message will be displayed.
Color	Select a value from the drop-down menu to specify the color for the message to be displayed.
Message	Enter the contents of the message.
Update	Click this button to allow the settings to take effect.
Cancel	Click this button to cancel this editing operation.

### Tips & Warnings

---



1. Instant messages have a higher priority than common messages, meaning that if any of the instant messages have been enabled, any scheduled common messages in the sequence will be ignored until all instant messages have been disabled.
  2. Each time the settings for a message are changed, you will need to click the respective Update button for that message.
-

In the form for message **No. 1**, specify the following parameters:

- i. Check the **Display Status** checkbox
- ii. Select the desired color from the **Color** drop-down menu
- iii. Enter the following string in the **Message** text field:  
Hello World!
- iv. Click the **Update** button

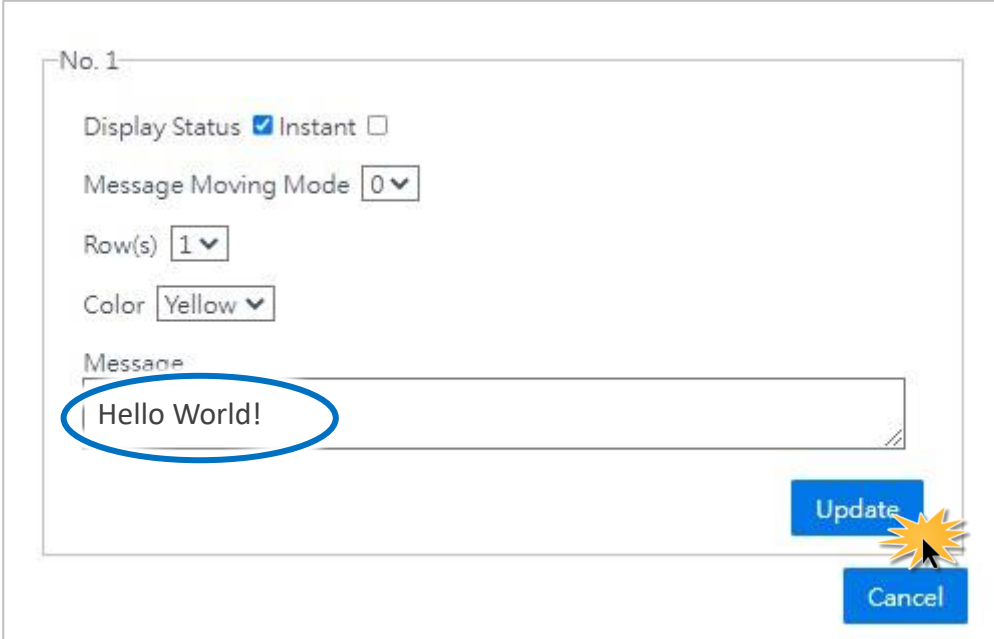

The screenshot shows a configuration window titled "No. 1". It contains the following elements:

- Display Status**: A checkbox labeled "Instant" is checked.
- Message Moving Mode**: A dropdown menu showing "0".
- Row(s)**: A dropdown menu showing "1".
- Color**: A dropdown menu showing "Yellow".
- Message**: A text input field containing "Hello World!". This field is circled in blue.
- Buttons**: "Update" and "Cancel" buttons are located at the bottom right. A mouse cursor is clicking the "Update" button, which is highlighted with a yellow starburst effect.

The text message will be shown on the display.

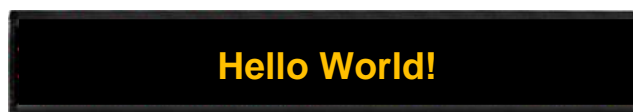

## 4.2. Displaying Messages with Variables

The iKAN series device allows data related to items such as the Ethernet configuration, the RTC value, and other information, to be inserted into a message as a system variable. The format for using a system variable in a message that has a length of 5 bytes is as follows:

1	2	3 to 5		
Delimiter Character	Variable Type	Modbus Address: 3-digit decimal number		
%	y: System variable	X	X	X
	a: ASCII string			
	b: Coil			
	u: Unsigned integer (0 to 65535)			
	i: Signed integer (-32768 to 32767)			
	f: Float (-3.4E+38 to +3.4E+38)			

The following describes the Modbus register map for the iKAN device that can be used on the iKAN display.

### Coil-type variables (0xxxx, 0 based)

Modbus Address		Length	Description	Value Range	Attribute
Decimal	Hex.				
00000 : 00039	0000 : 0027	40	Coil-type variables	-	R/W
00100 : 00227	0064 : 00E3	128	Enables or disables the display of common messages 0 to 127.	0: Disabled 1: Enabled	R/W

## System variables (3xxxx, 0 based)

Modbus Address		Length	Description	Value Range	Attribute
Decimal	Hex.				
30000 : 30003	0000 : 0003	4	The IP address for the iKAN series device	0 to 255	R
30004 : 30007	0004 : 0007	4	The Mask address for the iKAN series device	0 to 255	R
30008 : 30011	0008 : 000B	4	The Gateway address for the iKAN series device	0 to 255	R
30012	000C	1	Year	0 to 9999	R
30013	000D	1	Month	1 to 12	R
30014	000E	1	Day	1 to 31	R
30015	000F	1	Abbreviated day of the week: SUN, MON, TUE, WED, THU, FRI, SAT	0 to 6	R
30016	0010	1	Day of the week: Sunday, Monday, Tuesday, Wednesday, Thursday, Friday, Saturday	0 to 6	R
30017	0011	1	Day of the week in Chinese characters: 日、一、二、三、四、 五、六	0 to 6	R
30018	0012	1	Hours (24-hour format)	0 to 23	R
30019	0013	1	Minutes	0 to 59	R
30020	0014	1	Seconds	0 to 59	R

## Integer-type variables/Float-type variables/misc. (4xxxx, 0 based)

Modbus Address		Length	Description	Value Range	Attribute
Decimal	Hex.				
40000 : 40063	0000 : 003F	64	Integer-type variables	0 to 65535	R/W
40128 : 40255	0080 : 00FF	64	Float-type variables	3.4E+38 to +3.4E+38	R/W
40384 : 40447	0180 : 01BF	64	Data mapping arguments: Source Low	0 to 65535	R/W
40512 : 40475	0200 : 023F	64	Data mapping arguments: Source High	0 to 65535	R/W
40640 : 40703	0280 : 02BF	64	Data mapping arguments: Target Low	0 to 65535	R/W
40768 : 40831	0300 : 033F	64	Data mapping arguments: Target High	0 to 65535	R/W
40896 : 40959	0380 : 03BF	64	Data mapping arguments: Decimal Places	0 to 2	R/W
41024 : 41087	0400 : 043F	64	Decimal Places for float-type variables	1 to 3	R/W
41408 : 41535	0580 : 05FF	128	Color for common messages 0 to 127 in the first row.	1: Blue 2: Green 3: Sky Blue 4: Red 5: Purple 6: Yellow 7: White 8: Random	R/W

41600	0640	1	Brightness for the display, a smaller number means a brighter screen	0 to 4	R/W
41601	0641	1	Message scrolling speed. A smaller value denotes a greater speed.	0 to 9	R/W
41602	0642	1	Modbus Station ID	1 to 254	R/W
41604	0644	1	Modbus TCP Slave port	0 to 65535	R/W
41612	0652	1	The response timeout value for Modbus TCP communication	0 to 65535	R/W
41613	0653	1	The delay between polls for Modbus TCP communication	0 to 65535	R/W
41632 : 41759	0660 : 06DF	128	The priority for messages 0 to 127	0: Common 1: Instant	R/W
41800 : 41831	0708 : 0727	32	The contents of ASCII string 0	ASCII	R/W
41832 : 41863	0728 : 0747	32	The contents of ASCII string 1	ASCII	R/W
41864 : 41895	0748 : 0767	32	The contents of ASCII string 2	ASCII	R/W
41896 : 41927	0768 : 0787	32	The contents of ASCII string 3	ASCII	R/W
41928 : 41959	0788 : 07A7	32	The contents of ASCII string 4	ASCII	R/W
41960 : 41991	07A8 : 07C7	32	The contents of ASCII string 5	ASCII	R/W
41992 : 42023	07C8 : 07E7	32	The contents of ASCII string 6	ASCII	R/W

42024 : 42055	07E8 : 0808	32	The contents of ASCII string 7	ASCII	R/W
42100 : 42227	0834 : 08B3	128	The color of messages 0 to 127 on the second row.	1: Blue 2: Green 3: Sky Blue 4: Red 5: Purple 6: Yellow 7: White 8: Random	R/W
42300 : 42427	08FC : 097B	128	The message moving type for messages 0 to 127	0 to 3	R/W
42500 : 42539	08FC : 09EB	40	The color for the coil variables 0 to 39	1: Blue 2: Green 3: Sky Blue	R/W
42700 : 42763	0A8C : 0ACB	64	The color for integer variables 0 to 63	4: Red 5: Purple 6: Yellow	R/W
42700 : 42763	0A8C : 0ACB	64	The color for float variables 0 to 63	7: White 8: Random	R/W

## 4.2.1. Inserting System Variables into a Message

The iKAN series device allows data related to items such as the Ethernet configuration, the RTC value, and other information, to be inserted into a message as a system variable. The format for using a system variable in a message that has a length of 5 bytes is as follows:

1	2	3 to 5		
Delimiter Character	Variable Type	Modbus Address: 3-digit decimal number		
%	y: System variable	X	X	X

### 4.2.1.1. Displaying the IP Address

Modbus register addresses 30000 to 30011 can be used to read the current IP, Mask, and Gateway address values. The following is an overview of how to read these addresses.

Modbus Address		Length	Description	Value Range	Attribute
Decimal	Hex.				
30000 : 30003	0000 : 0003	4	The IP address for the iKAN series device	0 to 255	R
30004 : 30007	0004 : 0007	4	The Mask address for the iKAN series device	0 to 255	R
30008 : 30011	0008 : 000B	4	The Gateway address for the iKAN series device	0 to 255	R



For example, the following explains how to configure a message to display the IP address for the iKAN series device in message 1.

1. Select message **No. 1** from the message pool, and then click the  button

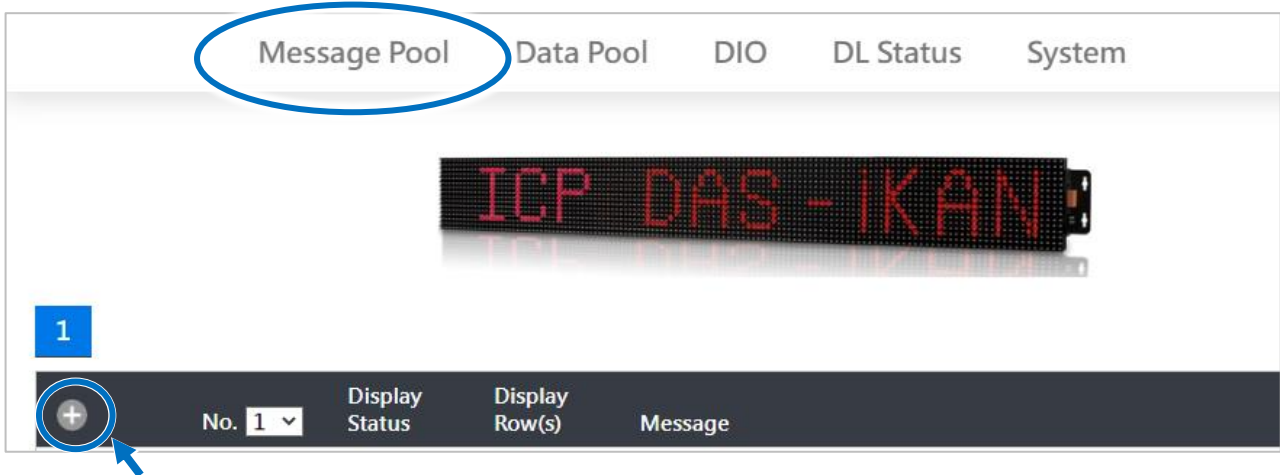

2. Click the  button

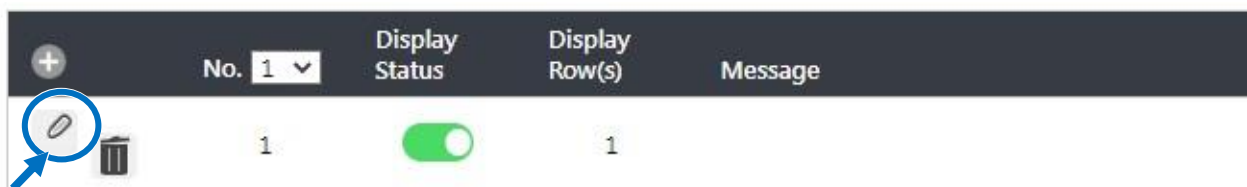

3. In the form for message **No. 1**, specify the following parameters:

- i. Check the **Display Status** checkbox
- ii. Select the desired color from the **Color** drop-down menu
- iii. Enter the following string in the **Message** text field:  
IP: %y000.%y001.%y002.%y003
- iv. Click the **Update** button

NO. 1

Display Status  Instant

Message Moving Mode

Row(s)

Color

Message

The IP address for the iKAN series device will be shown on the display.



## 4.2.1.2. Displaying the Current Date and Time

Modbus register addresses 30012 to 30020 can be used to read the current date and time value. The following is an overview of how to read these values.

Modbus Address		Length	Description	Value Range	Attribute
Decimal	Hex.				
30012	000C	1	Year	0 to 9999	R
30013	000D	1	Month	1 to 12	R
30014	000E	1	Day	1 to 31	R
30015	000F	1	Abbreviated day of the week: SUN, MON, TUE, WED, THU, FRI, SAT	0 to 6	R
30016	0010	1	Day of the week: Sunday, Monday, Tuesday, Wednesday, Thursday, Friday, Saturday	0 to 6	R
30017	0011	1	Day of the week in Chinese characters: 日、一、二、三、四、五、六	0 to 6	R
30018	0012	1	Hours (24-hour format)	0 to 23	R
30019	0013	1	Minutes	0 to 59	R
30020	0014	1	Seconds	0 to 59	R

For example, the following explains how to configure a message to display the current date for the iKAN series device in message 1:

1. Select message **No. 1** from the message pool, and then click the  button

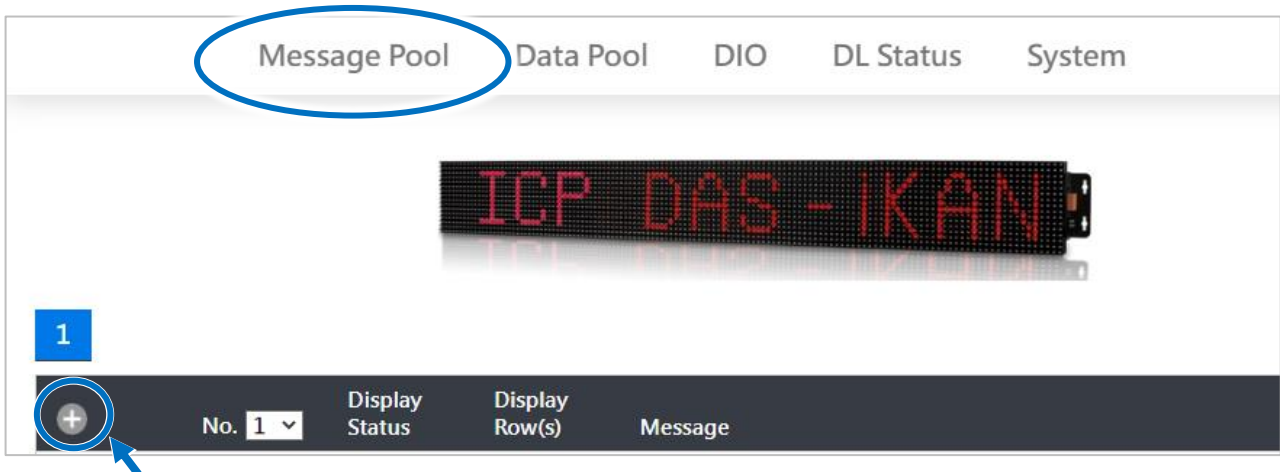

2. Click the  button

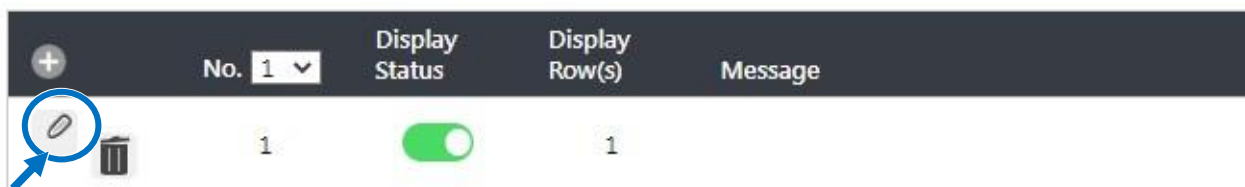

3. In the form for message **No. 1**, specify the following parameters:

- i. Check the **Display Status** checkbox
- ii. Select the desired color from the **Color** drop-down menu
- iii. Enter the following string in the **Message** text field:  
    %y012/%y013/%y014 %y018 : %y019
- iv. Click the **Update** button

NO. 1

Display Status  Instant

Message Moving Mode

Row(s)

Color

Message

The date and time for the iKAN series device will be shown on the display.



## 4.2.2. Inserting Integer-type Variables into a Message

iKAN display devices provide Modbus registers for 64 integer variables, allowing the Host PC or a PLC to read or write data via the Modbus TCP/ RTU protocol. These values can also be inserted into a message. If these inserted values are modified via a remote Host or a PLC, the value will be automatically refreshed when it is displayed on the iKAN series device.

The format for using a variable in a message is a 5-byte string as follows:

1	2	3 to 5		
Delimiter Character	Variable Type	Modbus Address: 3-digit decimal number		
%	u: Unsigned integer (0 to 65535)	X	X	X
	i: Signed integer (-32768 to 32767)			

A maximum of 64 integer variables can be stored on the iKAN series device, and are accessed using Modbus register addresses 40000 to 40063.

Modbus Address		Length	Description	Value Range	Attribute
Decimal	Hex.				
40000	0000	64	Integer-type variables	0 to 65535	R/W
:	:				
40063	003F				

For example, the following explains how to insert a signed type integer variable into Modbus register 40001 using message address 1.

1. Select message **No. 1** from the message pool, and then click the  button

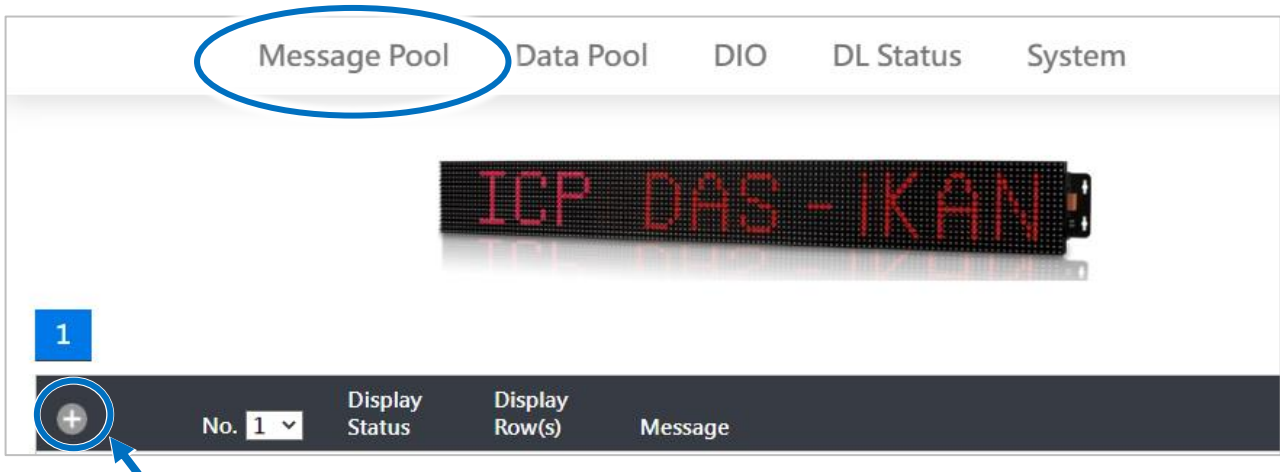

2. Click the  button

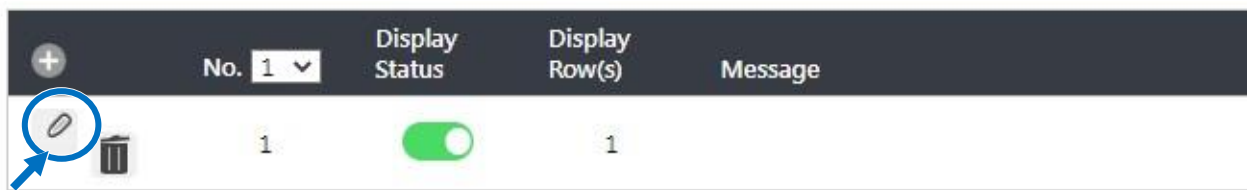

3. In the **No. 1** form, specify the following parameters:
  - i. Check the **Display Status** checkbox
  - ii. Select the desired color from the **Color** drop-down menu
  - iii. Enter the following string in the **Message** text field:  
Input Voltage: %i001 V
  - iv. Click the **Update** button

NO. 1

Display Status  Instant

Message Moving Mode

Row(s)

Color

Message

The message contains the value for integer variable 1 will be shown on the iKAN display.



The iKAN series device provides a data mapping function for Integer-type variables. Refer to [Section 4.3.1. Displaying Mapping Data for Integer-type Variables](#) for more details



### 4.2.3. Inserting Float-type Variables into a Message

The iKAN display device provides Modbus registers for 64 float variables, allowing the Host PC or a PLC to read or write data via the Modbus TCP/ RTU protocol. These values can also be inserted into a message. If these values are modified via a remote Host or a PLC, the value will be automatically refreshed when it is displayed on the iKAN series device.

The format for using a variable in a message is a 5-byte string, as follows:

1	2	3 to 5		
Delimiter Character	Variable Type	Modbus Address: 3-digit decimal number		
%	f: Float variable (-3.4E+38 ~ +3.4E+38)	X	X	X

A maximum of 64 float variables can be stored on the iKAN series device, and are accessed using Modbus register addresses 40128 to 40254.

Modbus Address		Length	Description	Value Range	Attribute
Decimal	Hex.				
40128	0080	64	Float-type variables	3.4E+38 ~ +3.4E+38	R/W
:	:				
40255	00FF				

For example, the following explains how to insert a float-type variable into Modbus register 40130 using message address 1.

1. Select message **No. 1** from the message pool, and then click the  button

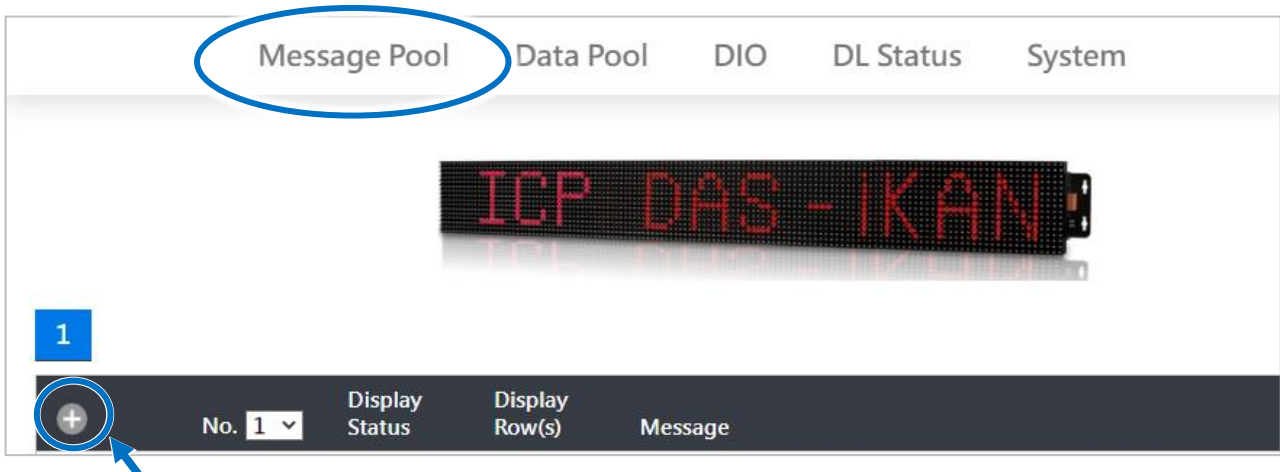

2. Click the  button

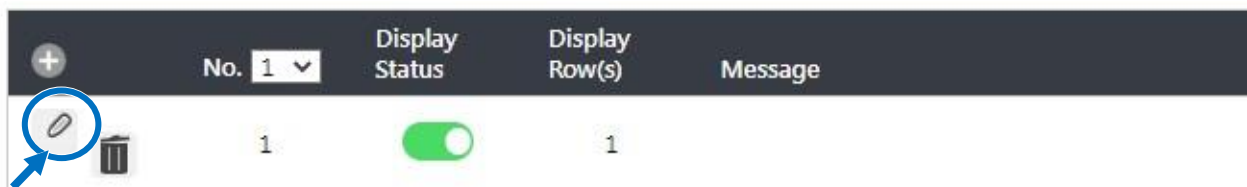

3. In the **No. 1** form, specify the following parameters:
  - i. Check the **Display Status** checkbox
  - ii. Select the desired color from the **Color** drop-down menu
  - iii. Enter the following string in the **Message** text field:  
Pressure: %f130 bars
  - iv. Click the **Update** button

NO. 1

Display Status  Instant

Message Moving Mode

Row(s)

Color

Message

The value for float-type variable 1 will be shown on the iKAN display.



The iKAN series device allows the number of decimal places to be modified for Float-type variables. Refer to [Section 4.3.2. Displaying a Value with a Specified Number of Decimal Places for Float-Type Variables](#) for more details

## 4.2.4. Inserting Coil-type Variables into a Message

The iKAN display device provides Modbus registers for 40 coil variables, allowing the Host PC or a PLC to read or write data via the Modbus TCP/ RTU protocol. These values can also be inserted into a message. If these values are modified via a remote Host or a PLC, the value will be automatically refreshed when it is displayed on the iKAN series device.

The format for using a variable in a message is a 5-byte string, as follows:

1	2	3 to 5		
Delimiter Character	Variable Type	Modbus Address: 3-digit decimal number		
%	b: Coil	X	X	X

A maximum of 40 Coil type variables can be stored on the iKAN series device, and are accessed using Modbus register addresses 00000 to 00039.

Modbus Address		Length	Description	Value Range	Attribute
Decimal	Hex.				
00000 : 00039	0000 : 0027	40	Coil-type variables	-	R/W

For example, the following explains how to insert a coil variable into Modbus register 00000 using message 1:

1. Select message **No. 1** from the message pool, and then click the  button

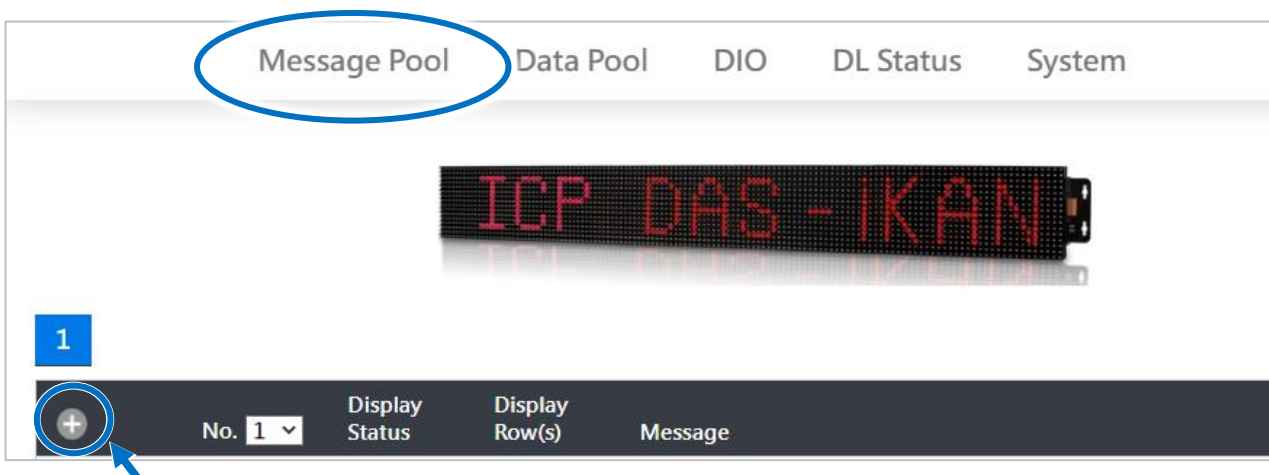

2. Click the  button

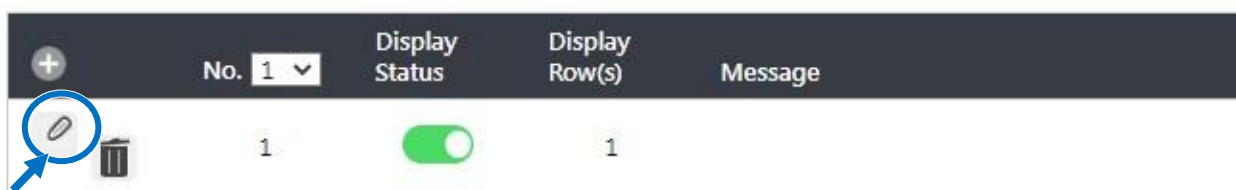

3. In the **No. 1** form, specify the following parameters:
  - i. Check the **Display Status** checkbox
  - ii. Select the desired color from the **Color** drop-down menu
  - iii. Enter the following string in the **Message** text field:  
Coil variable 1 = %b001
  - iv. Click the **Update** button

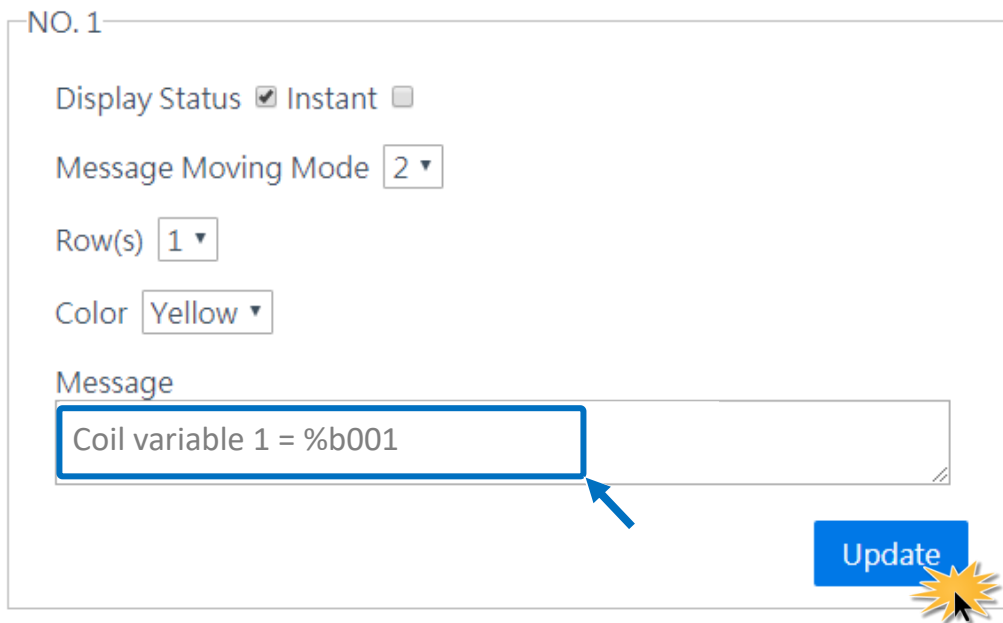

NO. 1

Display Status  Instant

Message Moving Mode

Row(s)

Color

Message

The value for Coil variable 1 will be shown on the iKAN display.



The iKAN series device provides a string mapping function that allows the value of the coil variable to be mapped. Refer to [Section 4.3.3. Displaying the Value of a Coil using Replacement Text](#) for more details

## 4.2.5. Inserting ASCII Strings into a Message

iKAN display devices provide Modbus registers for 8 ASCII strings, allowing the Host PC or a PLC to read or write data via the Modbus TCP/ RTU protocol. Each ASCII string is up to 64 characters (32 Modbus registers with 2 ASCII characters in each). These strings can be displayed in a similar way to display variables. If these strings are modified via a remote Host or a PLC, the text will be automatically refreshed when it is displayed on the iKAN series device.

The format for using a variable in a message is a 3-byte string as follows:

1	2	3
<b>Delimiter Character</b>	<b>Variable Type</b>	<b>ASCII String Number: 1-digit decimal number</b>
%	a: ASCII string	0 ~ 7

A maximum of 8 ASCII strings can be stored on the iKAN series device, and are accessed using Modbus register addresses 41800 to 42055.

Modbus Address		Length	Description	Value Range	Attribute
Decimal	Hex.				
41800 : 41831	0708 : 0727	32	ASCII string 0 contents	ASCII	R/W
41832 : 41863	0728 : 0747	32	ASCII string 1 contents	ASCII	R/W
41864 : 41895	0748 : 0767	32	ASCII string 2 contents	ASCII	R/W
41896 : 41927	0768 : 0787	32	ASCII string 3 contents	ASCII	R/W
41928 : 41959	0788 : 07A7	32	ASCII string 4 contents	ASCII	R/W
41960 : 41991	07A8 : 07C7	32	ASCII string 5 contents	ASCII	R/W
41992 : 42023	07C8 : 07E7	32	ASCII string 6 contents	ASCII	R/W
42024 : 42055	07E8 : 0808	32	ASCII string 7 contents	ASCII	R/W



For example, the following explains how to configure a message to display the contents of an ASCII string in a message at address 1:

1. Select message **No. 1** from the message pool, and then click the  button

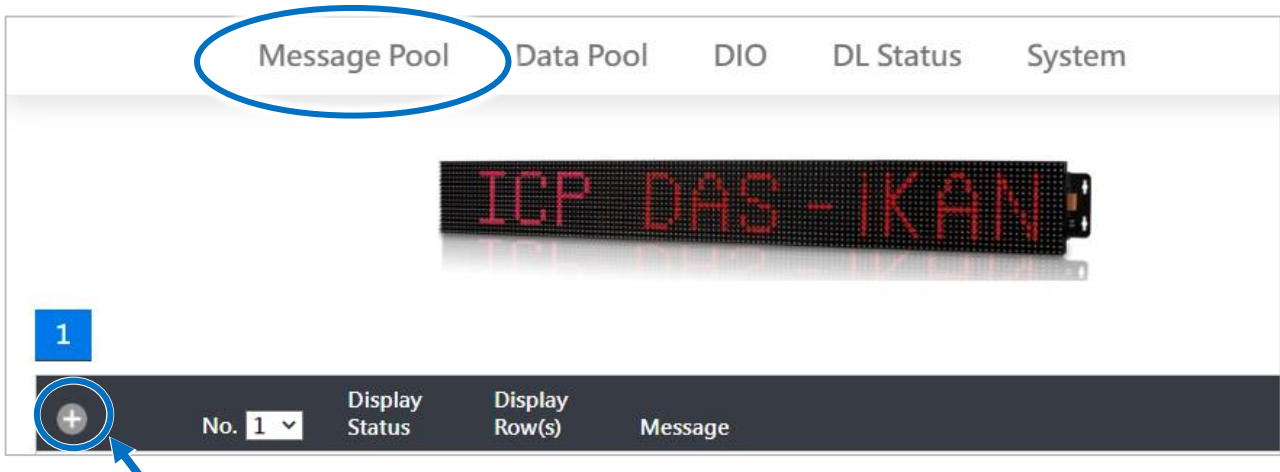

2. Click the  button

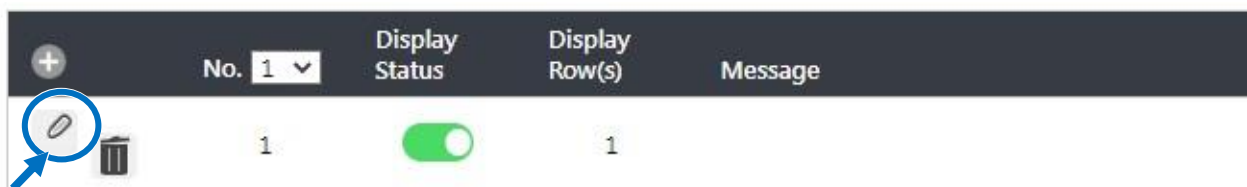

3. In the **No. 1** form, specify the following parameters:
  - i. Check the **Display Status** checkbox
  - ii. Select the desired color from the **Color** drop-down menu
  - iii. Enter the following string in the **Message** text field:
 

%a0
  - iv. Click the **Update** button

4. Use any software that supports Modbus RTU/TCP ASCII protocol to send the following value to the iKAN Modbus registers from 41800 to 41806.

	01800	01810	01820	01830
0	1800 = (AS) 0x4153	1810 = (??) 0x0000	1820 = (??) 0x0000	1830 = (??) 0x0000
1	1801 = (CI) 0x4349	1811 = (??) 0x0000	1821 = (??) 0x0000	1831 = (??) 0x0000
2	1802 = (I) 0x4920	1812 = (??) 0x0000	1822 = (??) 0x0000	
3	1803 = (st) 0x7374	1813 = (??) 0x0000	1823 = (??) 0x0000	
4	1804 = (ri) 0x7269	1814 = (??) 0x0000	1824 = (??) 0x0000	
5	1805 = (ng) 0x6E67	1815 = (??) 0x0000	1825 = (??) 0x0000	
6	1806 = (?! ) 0x0021	1816 = (??) 0x0000	1826 = (??) 0x0000	
7	1807 = (??) 0x0000	1817 = (??) 0x0000	1827 = (??) 0x0000	
8	1808 = (??) 0x0000	1818 = (??) 0x0000	1828 = (??) 0x0000	
9	1809 = (??) 0x0000	1819 = (??) 0x0000	1829 = (??) 0x0000	

The message sent to ASCII string 0 will be shown on the iKAN display.

**ASCII string!**

## 4.2.6. Inserting Unicode Strings into a Message

iKAN display devices provide Modbus registers for 1 Unicode strings, allowing the Host PC or a PLC to read or write data via the Modbus TCP/ RTU protocol. The Unicode string is up to 32 characters (32 Modbus registers with 1 Unicode character in each). The string can be displayed in a similar way to display variables. If the string is modified via a remote Host or a PLC, the text will be automatically refreshed when it is displayed on the iKAN series device.

The format for using a variable in a message is a 3-byte string as follows:

1	2	3
<b>Delimiter Character</b>	<b>Variable Type</b>	<b>Unicode String Number: 1-digit decimal number</b>
%	n: Unicode string	0

One Unicode strings can be stored on the iKAN series device, and can be accessed using Modbus register addresses 43000 to 43031.

Modbus Address		Length	Description	Value Range	Attribute
Decimal	Hex.				
43000	0BBB	32	Unicode string 0 contents	00A0 ~ FFFF	R/W
:	:				
43031	0BD7				

The color of each character in the Unicode string can be set individually, but the color will use up one Modbus register space. If the total length of the Unicode string is less than 32 characters, fill in 0 at the end address of the string as an end character.

The valid range of values that can be represented as characters in ASCII and Unicode strings:

Value Range	Descriptions		
0	End Character		
0x0001~0x0007	Character Color		
		Small Size	Normal Size
	1	Blue	Red
	2	Green	Green
	3	Sky Blue	Yellow
	4	Red	Blue
	5	Purple	Purple
	6	Yellow	Sky Blue
7	White	White	
0x0020~0x007F	ASCII Character		
0x00A0~0xFFFF	Unicode Character		

For example, the following explains how to configure a message to display the contents of an ASCII string in a message at address 1:

1. Select message **No. 1** from the message pool, and then click the  button

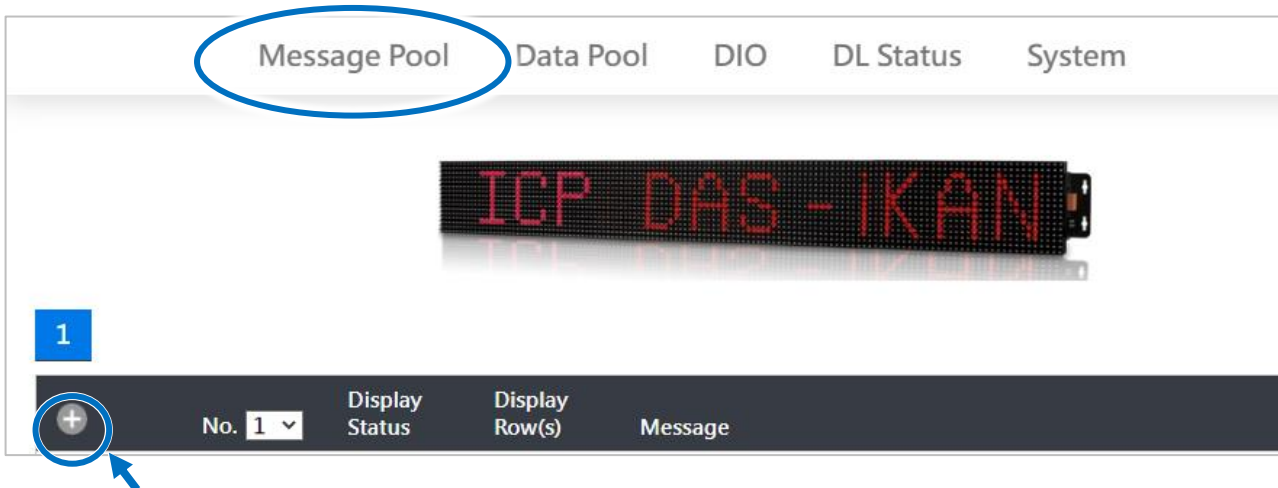

2. Click the  button

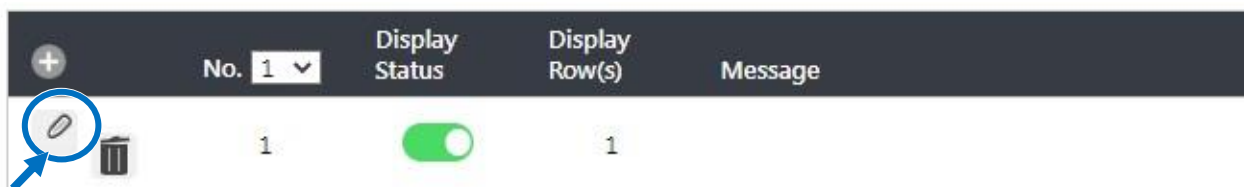

3. In the **No. 1** form, specify the following parameters:
  - i. Check the **Display Status** checkbox
  - ii. Select the desired color from the **Color** drop-down menu
  - iii. Enter the following string in the **Message** text field:
 

%n0
  - iv. Click the **Update** button

NO. 1

Display Status  Instant

Message Moving Mode

Row(s)

Color

Message

4. Use any software that supports Modbus RTU/TCP ASCII protocol to send the following value to the iKAN Modbus registers from 43000 to 43018.

	Alias	03000	Alias	03010
0	Set Color	(?) 0x0001	s	(?s) 0x0073
1	U	(?5) 0xFF35	t	(?t) 0x0074
2	n	(?N) 0xFF4E	r	(?r) 0x0072
3	i	(?! ) 0xFF49	i	(?i) 0x0069
4	c	(?C) 0xFF43	n	(?n) 0x006E
5	o	(?O) 0xFF4F	q	(?q) 0x0067
6	d	(?D) 0xFF44	Set Color	(?) 0x0004
7	e	(?E) 0xFF45	!	(?! ) 0x0021
8		(? ) 0x0020	End	(?) 0x0000
9	Set Color	(?) 0x0006		(?) 0x0000

The stored value for Unicode string will be shown on the iKAN display.

**Unicode string!**

### 4.3. Displaying a Value Applied using a Variable Map

Sometimes, displaying raw data from Modbus protocol in message is not easy to understand intuitively. For example, uses a value of 0 or 1 of a Coil variable to indicate the status of a button or a digital signal, or the value range -32768 to 36767 to denote the voltage range -10 V to +10 V. Therefore, iKAN provides the function of variable map to convert raw data to a readable physical value or easy-to-understand text.

Current variable maps are listed on the DATA POOL page. The value of most variables can be individually pre-configured via the variable maps page.

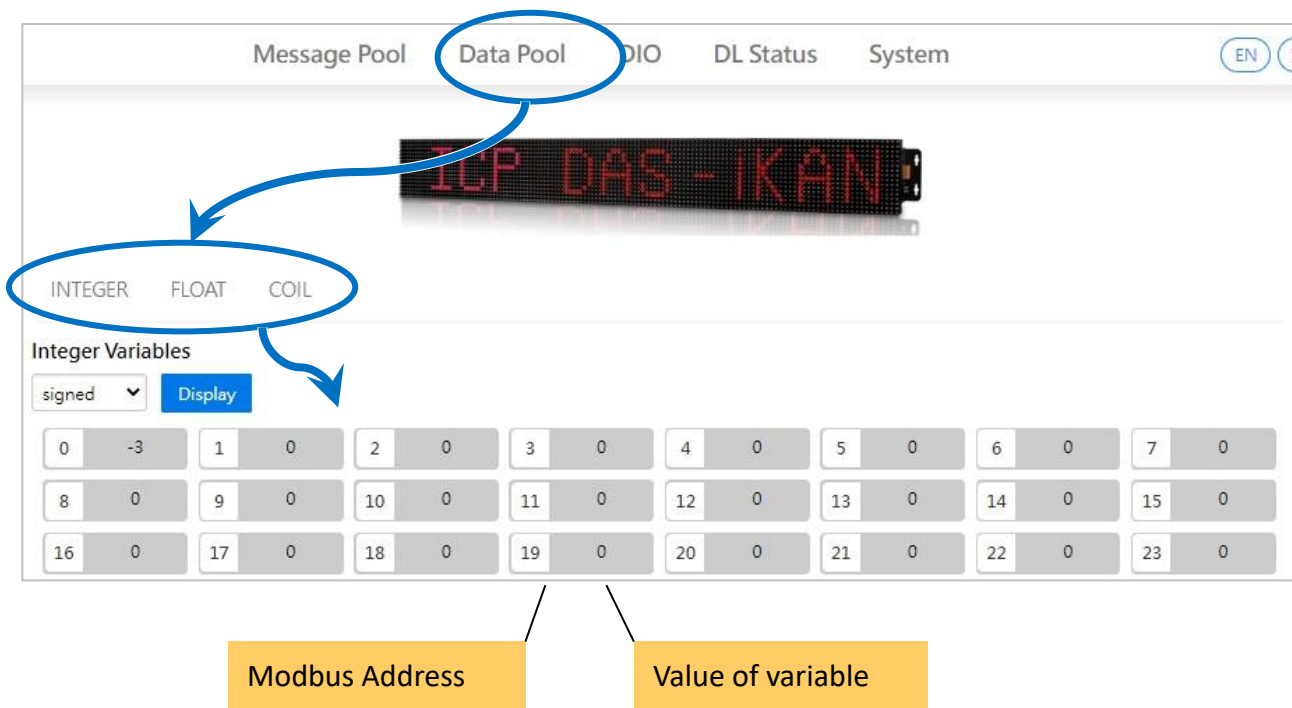

### 4.3.1. Displaying Mapping Data for Integer-type Variables

Most industrial measuring devices use 16-bit integers to convert a value from a data source to a real physical value, such as the voltage, temperature, or relative humidity, etc. For example, using the value range -32768 to 36767 to convert to the voltage range -10 V to +10 V. The iKAN series device is able to perform data mapping to translate an integer value that has been read from a remote data source to a readable physical value.

For example, the following explains how to configure the data mapping function for an integer-type variable at address 1.

Note that this example is a continuation of the example given in Section 4.2.2.

1. On the **INTEGER** page, click the variable at address 1, and then click the **Adv. Config** button

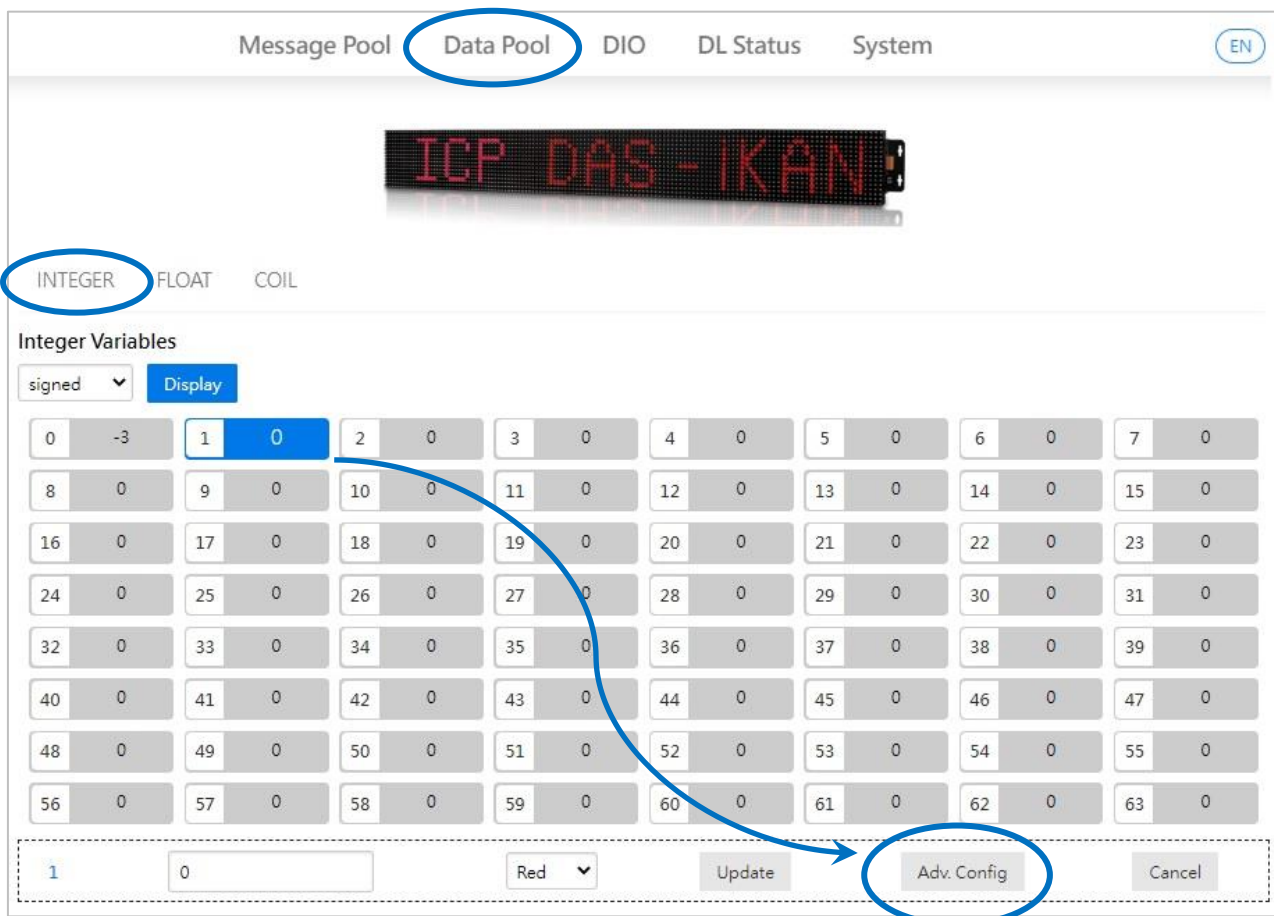



## 2. Consider the arguments for data mapping

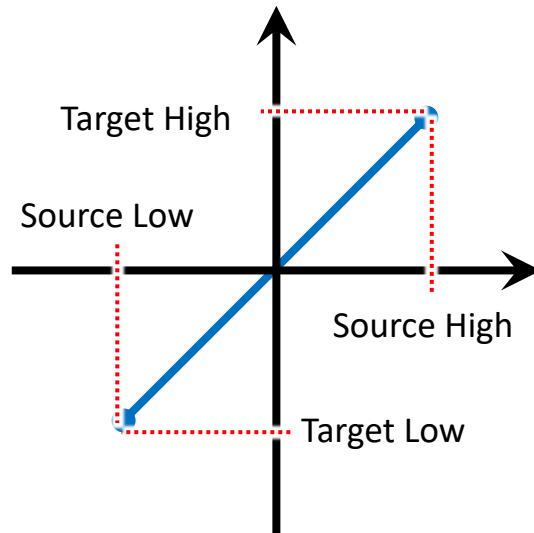

For example, to convert a 16-bit unsigned integer (0 to 65535) to the voltage 0 to 10 V, set the following arguments:

Argument	Value	Description
Source Low	0	The minimum value of the integer
Target Low	0	The minimum value of the physical value
Source High	65535	The maximum value of the integer
Target High	10	The maximum value of the physical value
Decimal Places	-	The number of decimal places to be used for the converted value

3. Enter the following value, and then click the **Update** button
  - i. In the **Source Low** column, enter the minimum value of the integer value.
  - ii. In the **Source High** column, enter the maximum value of the integer value.
  - iii. In the **Target Low** column, enter the minimum value of the physical value.
  - iv. In the **Target High** column, enter the maximum value of the physical value.
  - v. From the **Decimal Places** column, select the desired number of decimal places to be used for the converted value.

No.	Source Low	Source High	Target Low	Target High	Decimal Places	Update
1	<input type="text" value="0"/>	<input type="text" value="65535"/>	<input type="text" value="0"/>	<input type="text" value="10"/>	<input type="text" value="2"/>	<input type="button" value="Update"/>



The value for integer variable 1 will be shown on the iKAN display, but will now use the scaled value text rather than the integer value.

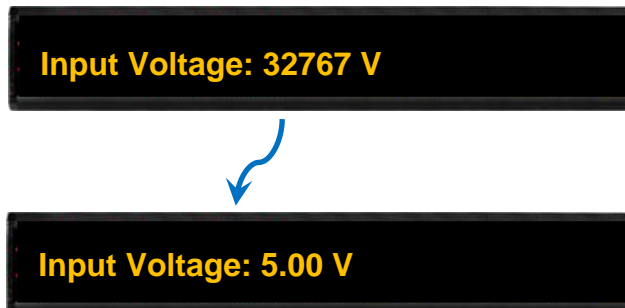

### 4.3.2. Displaying a Value with a Specified Number of Decimal Places for Float-type Variables

The number of the decimal places to be used for a float-type variable can be set from the FLOAT page. The offset value of Modbus address for float-type variables is 40128, which means variable 0 uses address 40128 and variable1 uses address 40130, and so on. A maximum of three decimal places can be set.

For example, the following explains how to set the number of decimal places for float-type variable 40130.

Note that this example is a continuation of the example given in Section 4.2.3.

1. On the **FLOAT** page, click the option for address **130**, and then click the **Adv. Config** button

The screenshot shows the 'Data Pool' tab selected. At the top, a red LED display shows 'ICP DAS - iKAN'. Below it, there are tabs for 'INTEGER', 'FLOAT', and 'COIL', with 'FLOAT' selected. A table of 'Float Variables' is displayed, with columns for 'Modbus Address' and 'Value of variable'. The variable at address 130 is highlighted in blue. Below the table, there is a configuration section for address 130, showing a value of 0 and a color dropdown set to Yellow. The 'Adv. Config' button is circled in blue. Callouts point to the 'Data Pool' tab, the 'FLOAT' tab, the 'Adv. Config' button, and the configuration fields.

Modbus Address	Value of variable
128	0.0
130	0.0
132	0.0
134	0.0
136	0.0
138	0.0
140	0.0
142	0.0
144	0.0
146	0.0
148	0.0
150	0.0
152	0.0
154	0.0
156	0.0
158	0.0
160	0.0
162	0.0
164	0.0
166	0.0
168	0.0
170	0.0
172	0.0
174	0.0
176	0.0
178	0.0
180	0.0
182	0.0
184	0.0
186	0.0
188	0.0
190	0.0
192	0.0
194	0.0
196	0.0
198	0.0
200	0.0
202	0.0
204	0.0
206	0.0
208	0.0
210	0.0
212	0.0
214	0.0
216	0.0
218	0.0
220	0.0
222	0.0
224	0.0
226	0.0
228	0.0
230	0.0
232	0.0
234	0.0
236	0.0
238	0.0
240	0.0
242	0.0
244	0.0
246	0.0
248	0.0
250	0.0
252	0.0
254	0.0

Configuration for address 130:

130	0	Yellow	Update	Adv. Config	Cancel
-----	---	--------	--------	-------------	--------

- From the **Decimal Places** drop-down menu, select the desired number of decimal places to be used, and then click the **Update** button

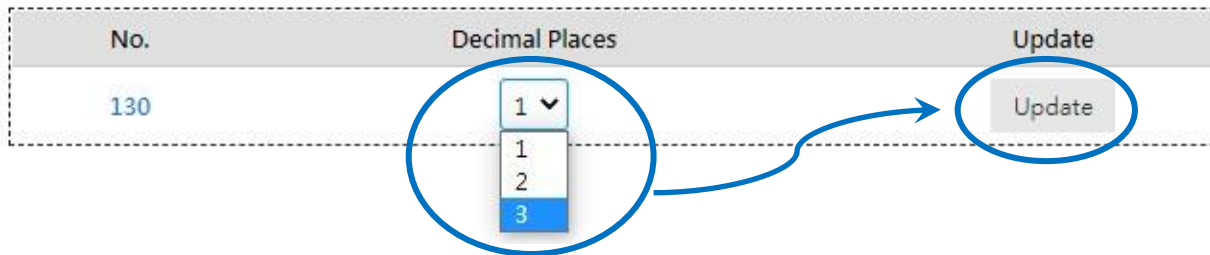

The value for float-type variable 1 will be shown on the iKAN display using the specified number of decimal places.



### 4.3.3. Displaying the Value of a Coil Variable using Replacement Text

The contents of a coil variable can be either 0 or 1, which is usually used to indicate the status of the Digital Output, i.e., ON or OFF.

On the **COIL** page, click the number for the address of the coil variable which you would like to configure. The configuration area has been populated based on the number of the address selected.

The screenshot displays the configuration interface for the iKAN Series Display. At the top, there are tabs for 'Message Pool', 'Data Pool' (circled in blue), 'DIO', 'DL Status', and 'System'. Below the tabs is a red LED display showing 'ICP DAS - iKAN'. Underneath the display are three variable type options: 'INTEGER', 'FLOAT', and 'COIL' (circled in blue). Below these options is a grid of 'Coil Variables' with addresses from 0 to 39. Address 1 is selected, and its value is 0. Below the grid is a configuration area for the selected variable (address 1). It shows the value '0' in a text box, a color dropdown menu set to 'Red', and buttons for 'Update', 'Adv. Config', and 'Cancel'. Two callout boxes point to the value and color fields:

- Change the value
- Change the color for displaying the value on the iKAN

The iKAN series device provides a string mapping function that allows the value of the coil variable to be mapped in order to make it more meaningful when reading the message. The text mapping function allows a maximum of 10 Unicode characters or 30 ASCII characters to be entered to represent a value of 0 or 1.

For example, the following explains how to configure the text mapping for the Coil variable at address 1. Note that this example is a continuation of the example given in Section 4.2.4.

1. On the **COIL** page, click the option for address **1**, and then click the **Adv. Config** button

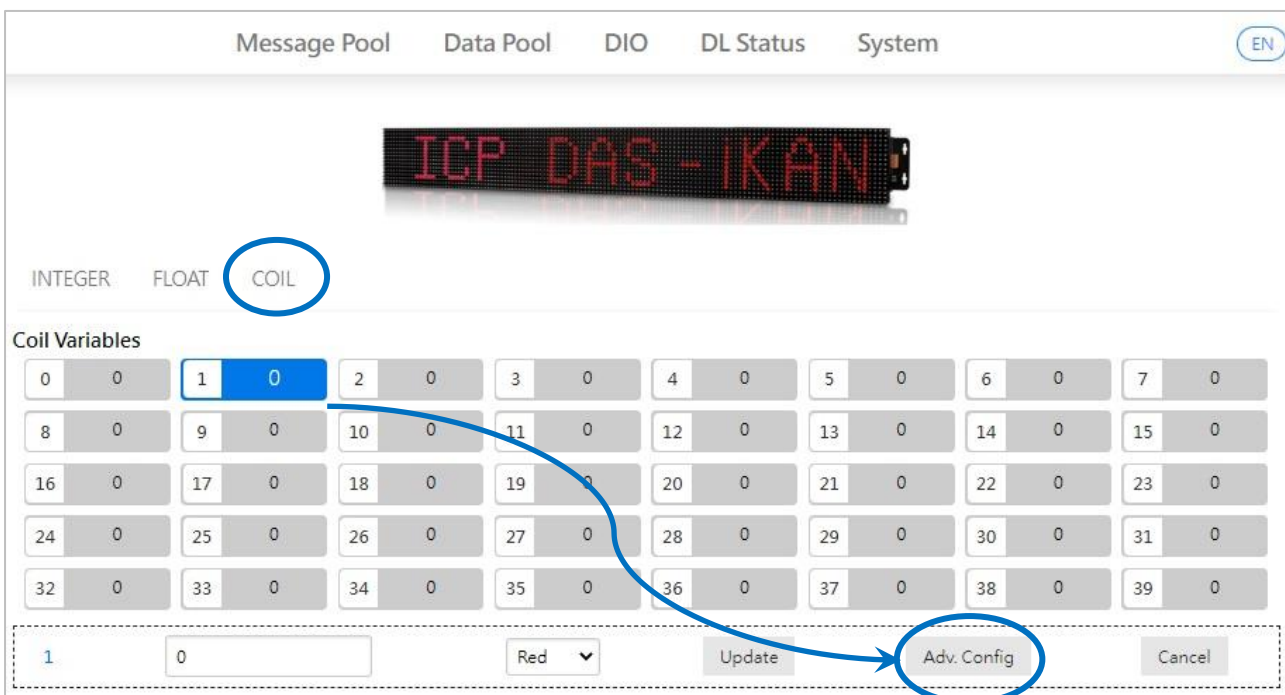

2. Enter the following mapping text, and then click the **Update** button
  - i. In the ON Text column, enter the mapping text in the text field for when the status of the coil-type variable is set to ON status.
  - ii. In the OFF Text column, enter the mapping text in the text field for when the status of the coil-type variable is set to OFF status.

No.	ON Text	OFF Text	Update	Cancel
1	<input type="text" value="Operating"/>	<input type="text" value="Stop"/>	<input type="button" value="Update"/>	<input type="button" value="Cancel"/>

The value for coil variable 1 is now replaced by the mapping text on the display.

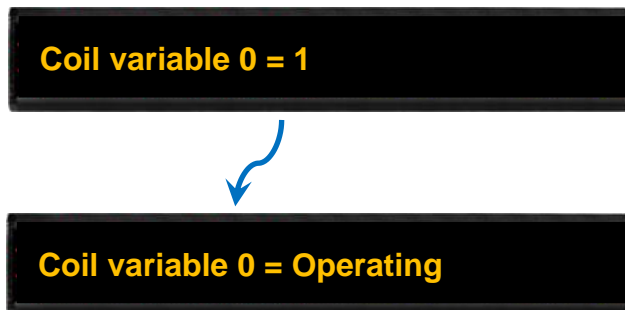

## 5. Displaying Data from CL/DL series modules

iKAN series devices can directly display measured data from DL/CL series air box modules connected to Ethernet or RS-485 interface. Up to 8 DL/CL series modules can be connected via Ethernet, as well as up to 16 modules can be connected to each RS-485 port. That is to say, one iKAN device can connect to up to 40 modules, and display the field measurement data in text message without a PC involved.

### Support Modules

Product	Model
DL series	DL-100-E, DL-101-E, DL-110-E, DL-120-E DL-301, DL-302, DL-303
CL series	CL-201-E, CL-202-E, CL-203-E, CL-204-E, CL-205-E CL-206-E, CL-207-E, CL-208-E, CL-210-E, CL-211-E CL-212-E, CL-213-E

Once the information for connecting to a CL/DL module is added via the System page, the Modbus address for each measurement item will be created automatically. It allows these measured values can be inserted into a message and updated to the latest value when they are displayed on the iKAN series device. It also allows remote host to access data from multiple modules with a Modbus TCP/RTU command.

Address (Base 0)	Description	Message Pool Symbol
512	DL-303(COM1->ID:4)CO	%y512
513	DL-303(COM1->ID:4)CO2	%y513
514	DL-303(COM1->ID:4)Relative Humidity	%y514
515	DL-	

Modbus address

Variable symbol



The measured data related to items such as temperature, relative humidity and concentration of CO/CO2 to be inserted into a message as a variable. The format for using a variable in a message is a 5-byte string, as follows:

1	2	3 to 5		
Delimiter Character	Variable Type	Modbus Address: 3-digit decimal number		
%	y: System variable	X	X	X

Simply enter the information for the connected modules and put the variable symbol for the measurement item into a message, and then the value of measurement data can be displayed in the message and be automatically refreshed when it is displayed on the iKAN series device.

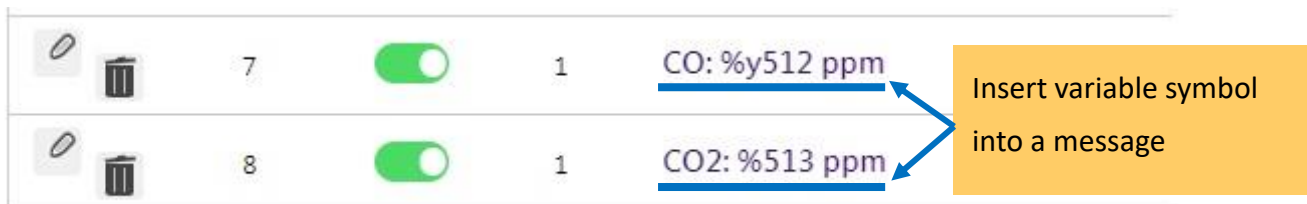

Before starting the configuration process, make sure that your CL/DL series device(s) is well configured and connected to the Ethernet or RS-485 port on the iKAN device. Also, confirm that the power of each device is turned on.

## 5.1. Displaying Data from CL/DL Modules Connected to Ethernet

### ☑ Enabling the Modbus TCP Master mode

1. Select **Connect to DL series module** from the drop-down menu in the Modbus TCP Master section on the Ethernet subpage of System, and then click Update Settings.

The screenshot shows the 'System' configuration page with the 'Ethernet' subpage selected. The 'Local Ethernet' section contains fields for DHCP (Disabled), IP Address (10.0.30.182), Mask (255.255.255.0), Gateway (10.0.30.254), and DNS (8.8.8.8). The 'Modbus TCP Slave' section shows Port 502 and NetID 1. The 'Modbus TCP Master' section has a dropdown menu with 'Connect to DL series module' selected. A blue circle with the number '1' points to this dropdown. Below the main configuration area, an 'Update Settings' button is highlighted with a yellow starburst and a blue circle with the number '2'. A blue arrow points from the 'Update Settings' button to a detailed view of the 'Modbus TCP Master' settings, which shows the dropdown menu with 'Connect to DL series module' selected, and fields for Timeout (2000) and Delay Between Polls (2000).

If necessary, you can adjust the values of the **Timeout** and **Delay Between Polls** parameters

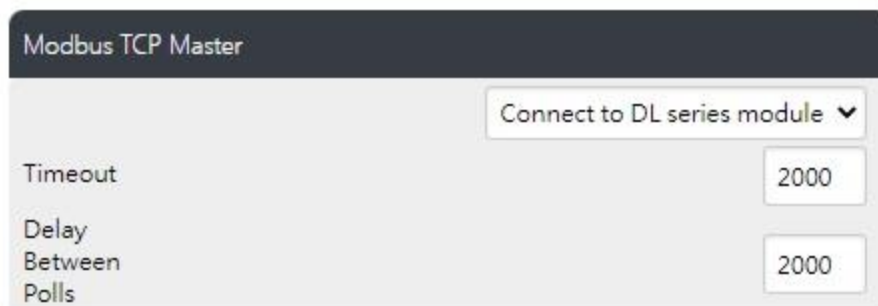

Modbus TCP Master

Connect to DL series module ▾

Timeout 2000

Delay Between Polls 2000

- **Timeout:** Set a timeout in ms to stop waiting and end the communication if the iKAN device does not receive data from the CL/DL series module within the time interval.
- **Delay Between Polls:** Set the delay time in ms for two Modbus TCP commands. The setting value needs be greater than 50ms.

2. Click the OK button on the pop-up dialog box.

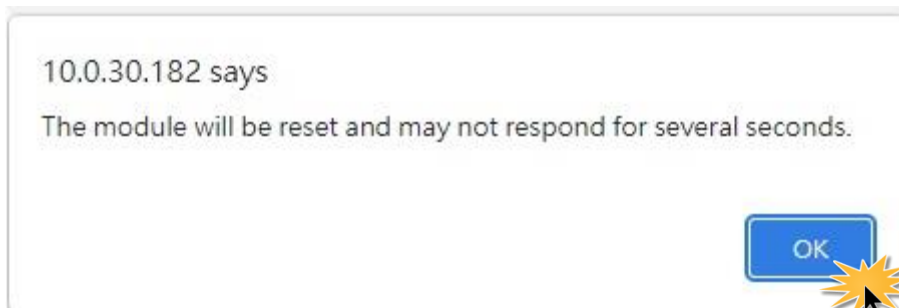

☑ Adding information for connecting CL/DL series module

3. Click the  icon for adding CL/DL series module in the title bar of DL Configuration Table.

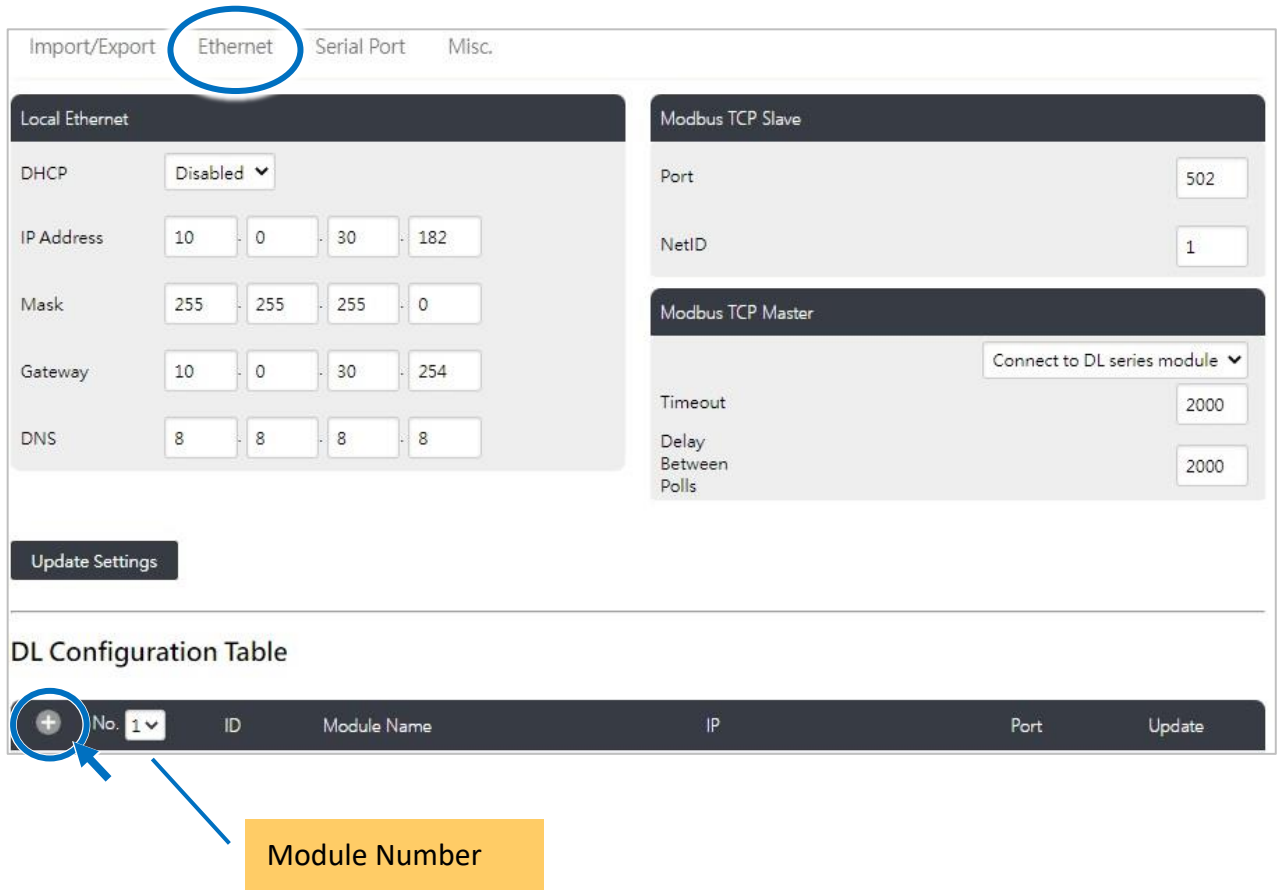

The screenshot displays a configuration interface with several sections:

- Import/Export**: A tab menu with 'Ethernet' selected and circled in blue.
- Local Ethernet**: A panel containing fields for DHCP (set to 'Disabled'), IP Address (10.0.30.182), Mask (255.255.255.0), Gateway (10.0.30.254), and DNS (8.8.8.8).
- Modbus TCP Slave**: A panel with fields for Port (502) and NetID (1).
- Modbus TCP Master**: A panel with a dropdown menu set to 'Connect to DL series module', and fields for Timeout (2000) and Delay Between Polls (2000).
- Update Settings**: A button located below the Local Ethernet panel.
- DL Configuration Table**: A table with columns: No., ID, Module Name, IP, Port, and Update. The 'No.' column has a dropdown menu showing '1'. A blue circle highlights a plus icon (+) in the top-left corner of the table header, with a blue arrow pointing to it. A yellow box labeled 'Module Number' is positioned below the table, with a blue arrow pointing from the plus icon to the box.

4. Enter the information into the relevant fields.

DL Configuration Table The configuration will be updated the next time you reset the iKAN display.

No.	ID	Module Name	IP			Port	Update
1	<input type="text" value="1"/>	DL-100-E	<input type="text" value="10"/>	<input type="text" value="0"/>	<input type="text" value="1"/>	<input type="text" value="1"/>	<input type="text" value="502"/> <input type="button" value="Save"/> <input type="button" value="Delete"/>

1 2 3 4 5 6

Item	Description
1	Checks the Module Number
2	Enters the Modbus ID for the module
3	Selects the model name
4	Enters the IP address of the module
5	Enters the port number for Modbus TCP communication. The standard port number is 502.
6	Clicks the <b>Save</b> button

5. Click the Reset button on the MISC page and wait the iKAN display to restart (about 8 seconds) to make the configuration take effect.

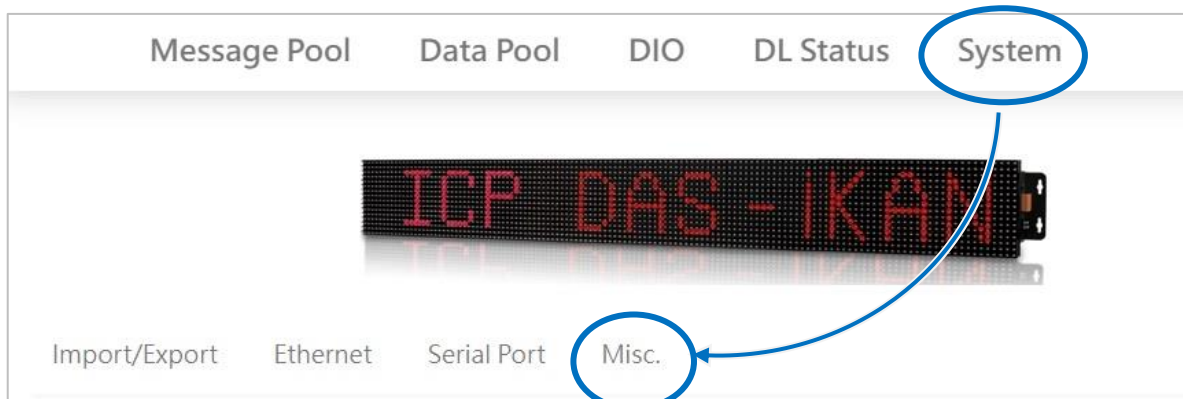

#### Software Reset

This function allows you to reset the display module by clicking the Reset button.



☑ **Obtaining real-time data of the monitoring module**

6. Click the reload icon to reload the entire page, and click LAN item on the **DL status** page to expand the list of module(s) connected over Ethernet.

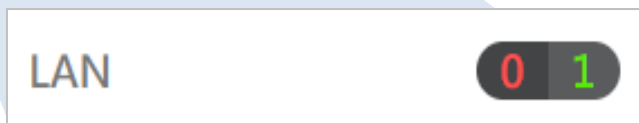
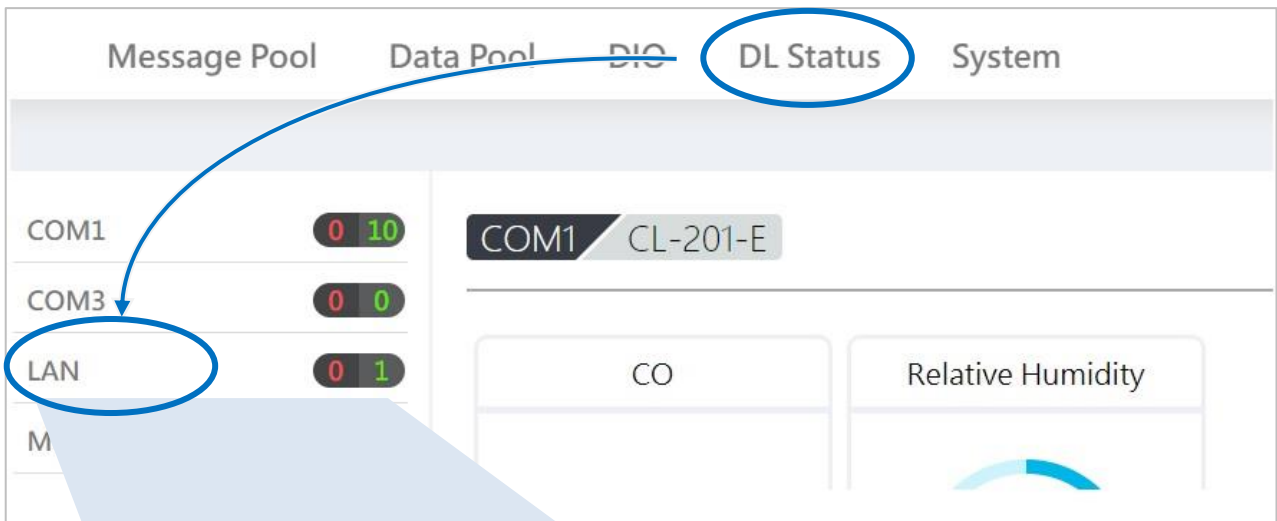

Click LAN to open the list of connected module(s)



7. Click the module in list to view the real-time data from the module.

The screenshot displays the iKAN Series Display interface. On the left, a list of connection interfaces is shown: COM1 (0 10), COM3 (0 0), LAN (CL-201-E (10.1.0.99:502/1)), and Modbus Table. The LAN module is selected, and its real-time data is displayed on the right. The data includes CO (0 ppm) and Relative Humidity (63.29 %). A yellow callout box explains that LAN is the connection interface and CL-201-E is the module name. Another yellow callout box points to the data display area, labeled 'Real-time data'.

Connection Interface	Module Name	CO (ppm)	Relative Humidity (%)
LAN	CL-201-E	0	63.29



☑ **Checking the variable symbol for measured items**

8. Click **Modbus Table** to view the table of contents for measurement items, their Modbus addresses and the variable symbols used to be inserted into a message.

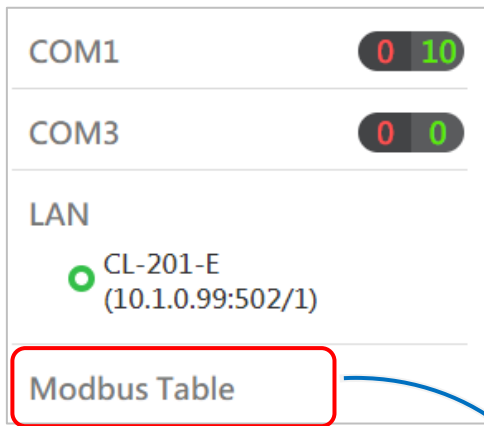

Modbus Register Table for DL Value (3xxxx)



Address (Base 0)	Description	Message Pool Symbol
519	DL-100-E(LAN IP:0.0.0.0/ID:1)Relative Humidity	%y519
520	DL-100-E(LAN IP:0.0.0.0/ID:1)Temperature (°C)	%y520
521	DL-100-E(LAN IP:0.0.0.0/ID:1)Temperature (°F)	%y521
522	DL-100-E(LAN IP:0.0.0.0/ID:1)Dew Point Temperature (°C)	%y522

Labels with arrows pointing to the table:





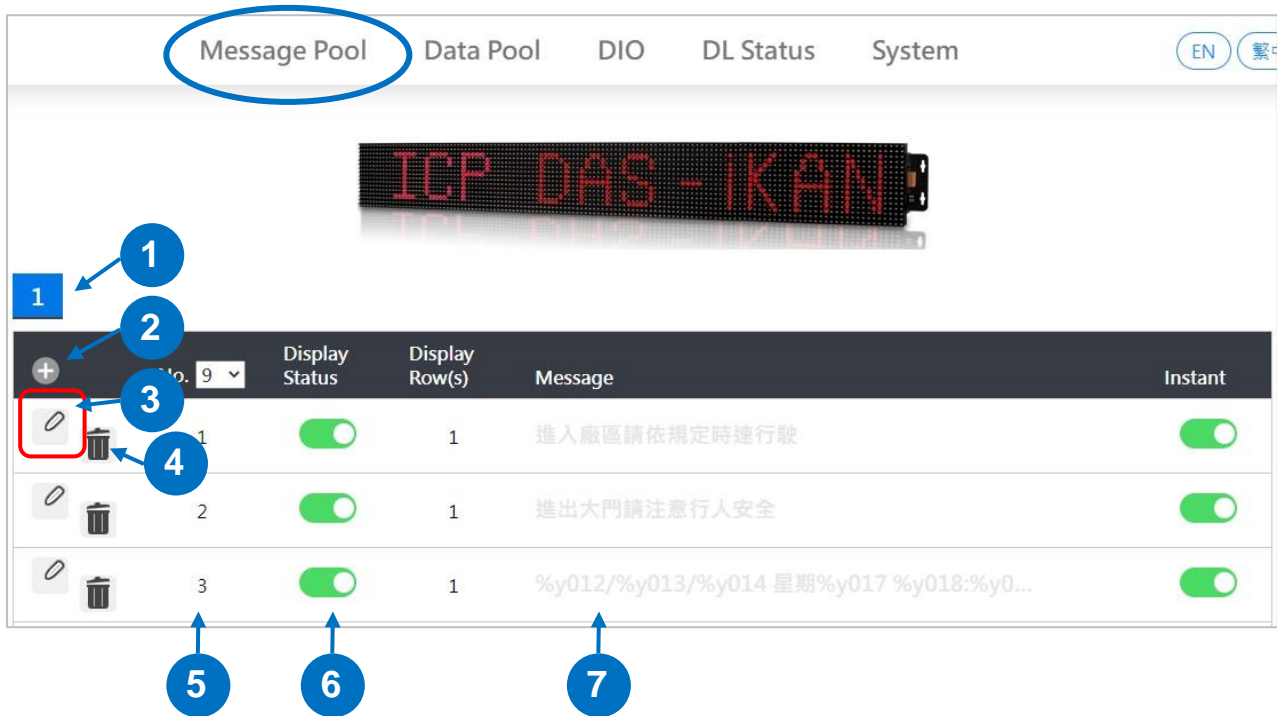

- Modbus address (points to 522)
- Variable symbol (points to %y522)

A large yellow rectangular box is positioned below the table, with an arrow pointing up to the 'Description' column.

☑ **Editing a message with a variable symbol**

9. Click the  icon to add a message and click the  icon to edit the message on the Message Pool page.



Item	Description
1	 The page number in Message Pool
2	 The icon for adding a message
3	 The icon for editing a message
4	 Clicks the icon to delete a message
5	Message number
6	 To Enable/  Disable the display of a message
7	The content of a message

10. Insert the desired variable symbol into a message such as **Temperature: %y520 C** and click the Update button.

No. 1

Display Status  Instant

Message Moving Mode

Row(s)

Color

Message

Temperature: %y520 C

Update

Cancel

11. Check the message is correctly displayed with measured value from the CL/DL series module.

**Temperature: 25.6 C**

## 5.2. Displaying Data from CL/DL Modules Connected to RS-485

### ☑ Enabling the Modbus RTU Master mode

1. Select the COM port used to connect the CL/DL series module.
2. Select **Connect to DL series modules** from the drop-down menu in the Modbus RTU Master section on the Serial Port subpage of System, and then click the **Save Settings** button.

The screenshot displays the configuration interface for the iKAN Series Display. The top navigation bar includes tabs for Message Pool, Data Pool, DIO, DL Status, and System. The System tab is selected and circled in blue. Below the navigation bar is a red LED display showing "ICP DAS iKAN". The main content area has tabs for Import/Export, Ethernet, Serial Port, and Misc. The Serial Port tab is selected and circled in blue. Under the Serial Port tab, there are two sub-sections: "Serial Port > COM1" and "Modbus RTU Master". The "Serial Port > COM1" section contains fields for Baud Rate (115200), Data Bits (8), Stop Bit(s) (1), and Parity (None). The "Modbus RTU Master" section contains a Mode dropdown menu. The dropdown menu is open, showing "Disable" and "Connect to DL series modules" (highlighted in blue). A blue arrow points from the "System" tab to the "Serial Port" tab, and another blue arrow points from the "Serial Port" tab to the "COM 1" tab. A blue circle with the number "1" is placed over the "COM 1" tab. A blue circle with the number "2" is placed over the "Connect to DL series modules" option in the dropdown menu. A blue circle with the number "3" is placed over the "Save Settings" button. A blue arrow points from the "Save Settings" button to a smaller screenshot of the "Modbus RTU Master" section, which shows the Mode dropdown menu set to "Connect to DL series modules" and other fields like Timeout (300) and Delay Between Polls (200).

If necessary, you can adjust the values for **Timeout** and **Delay Between Polls** parameters

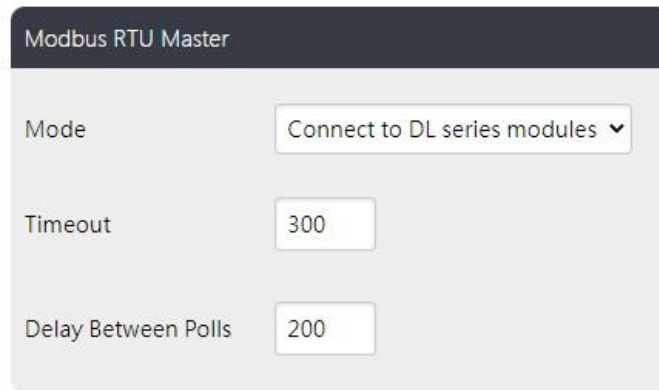

The image shows a configuration dialog box titled "Modbus RTU Master". It contains three settings: "Mode" is set to "Connect to DL series modules" (indicated by a dropdown arrow), "Timeout" is set to "300", and "Delay Between Polls" is set to "200".

- **Timeout:** Set a timeout in ms to stop waiting and end the communication if the iKAN device does not receive data from the CL/DL series module within the time interval.
- **Delay Between Polls:** Set the delay time in ms for two Modbus TCP commands. The setting value needs be greater than 50ms.

3. Click the OK button on the pop-up dialog box.

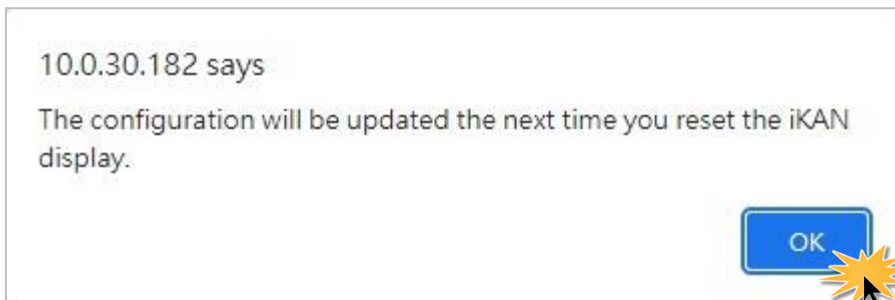

☑ Adding information for connecting CL/DL series module

4. Click the  icon for adding CL/DL series module in the title bar of DL Configuration Table.

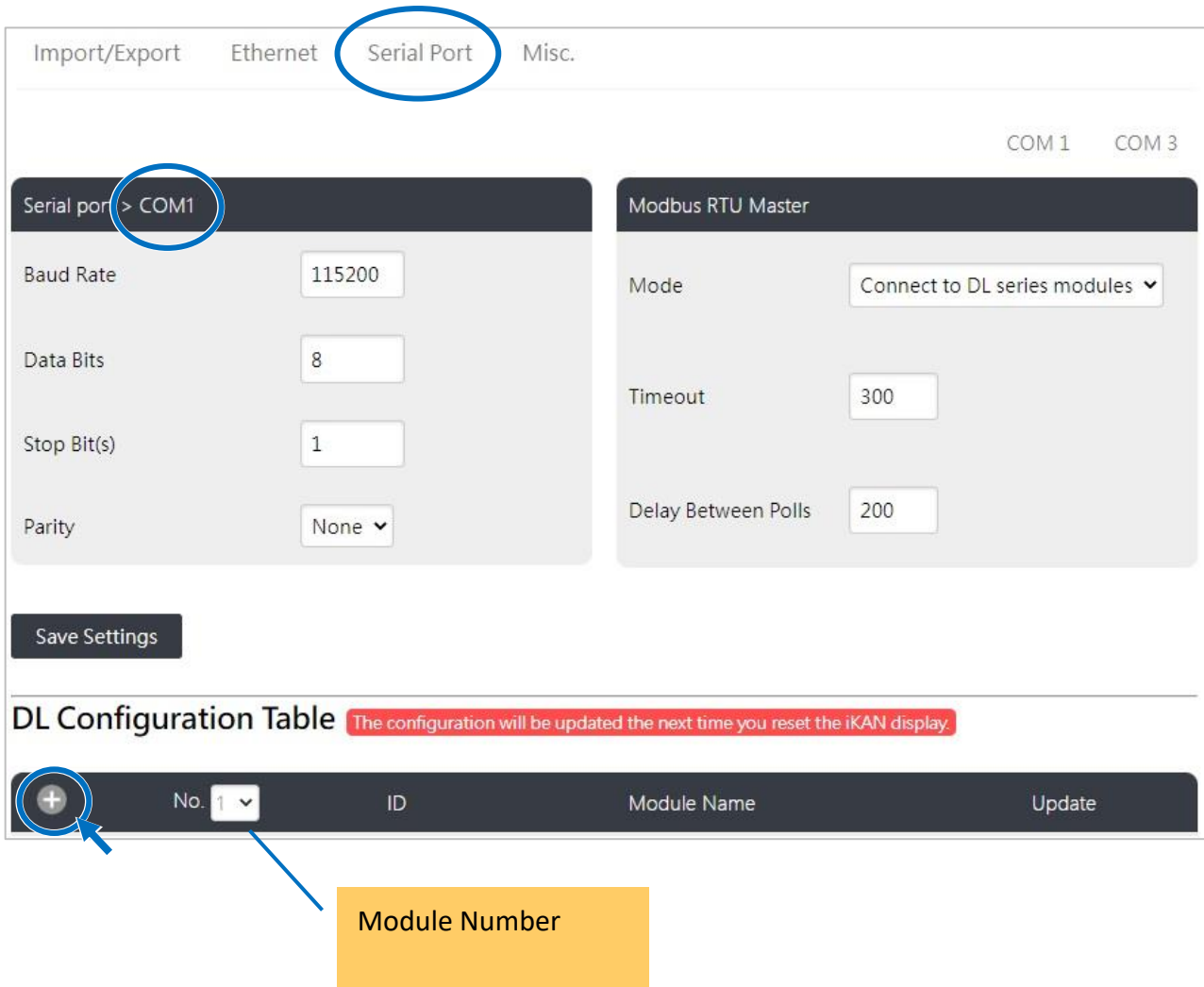

The screenshot displays the configuration interface for the iKAN series display. At the top, there are tabs for 'Import/Export', 'Ethernet', 'Serial Port', and 'Misc.'. The 'Serial Port' tab is selected and circled in blue. Below the tabs, there are two main sections: 'Serial port > COM1' and 'Modbus RTU Master'. The 'Serial port > COM1' section has a dropdown menu circled in blue, showing 'COM1'. Below this are input fields for 'Baud Rate' (115200), 'Data Bits' (8), 'Stop Bit(s)' (1), and 'Parity' (None). The 'Modbus RTU Master' section has a dropdown menu for 'Mode' set to 'Connect to DL series modules', and input fields for 'Timeout' (300) and 'Delay Between Polls' (200). A 'Save Settings' button is located below these sections. At the bottom, there is a 'DL Configuration Table' with a red warning message: 'The configuration will be updated the next time you reset the iKAN display.' The table has columns for 'No.', 'ID', 'Module Name', and 'Update'. The 'No.' column has a dropdown menu showing '1'. A plus icon in the table header is circled in blue, and a yellow box labeled 'Module Number' points to the 'No.' dropdown.

5. Enter the information into the relevant fields.

**DL Configuration Table** The configuration will be updated the next time you reset the iKAN display.

No.	ID	Module Name	Update
1	4	DL-303	Save

1    
 2    
 3    
 4

Item	Description
1	Checks the Module Number
2	Enters the Modbus ID for the module
3	Selects the model name
4	Clicks the <b>Save</b> button

6. Click the Reset button on the MISC page and wait the iKAN display to restart (about 8 seconds) to make the configuration take effect.

The screenshot shows the configuration interface with the following elements:

- Navigation tabs: Message Pool, Data Pool, DIO, DL Status, **System** (circled in blue), Import/Export, Ethernet, Serial Port, **Misc.** (circled in blue).
- Display: A red LED display showing "ICP DAS - iKAN".
- Section: **Software Reset**
- Description: "This function allows you to reset the display module by clicking the Reset button."
- Action: A **Reset** button (circled in blue) with a mouse cursor clicking it.

☑ **Obtaining real-time data of the monitoring module**

7. Click the reload icon to reload the entire page, and click COM Port item on the **DL status** page to expand the list of module(s) connected over Ethernet.

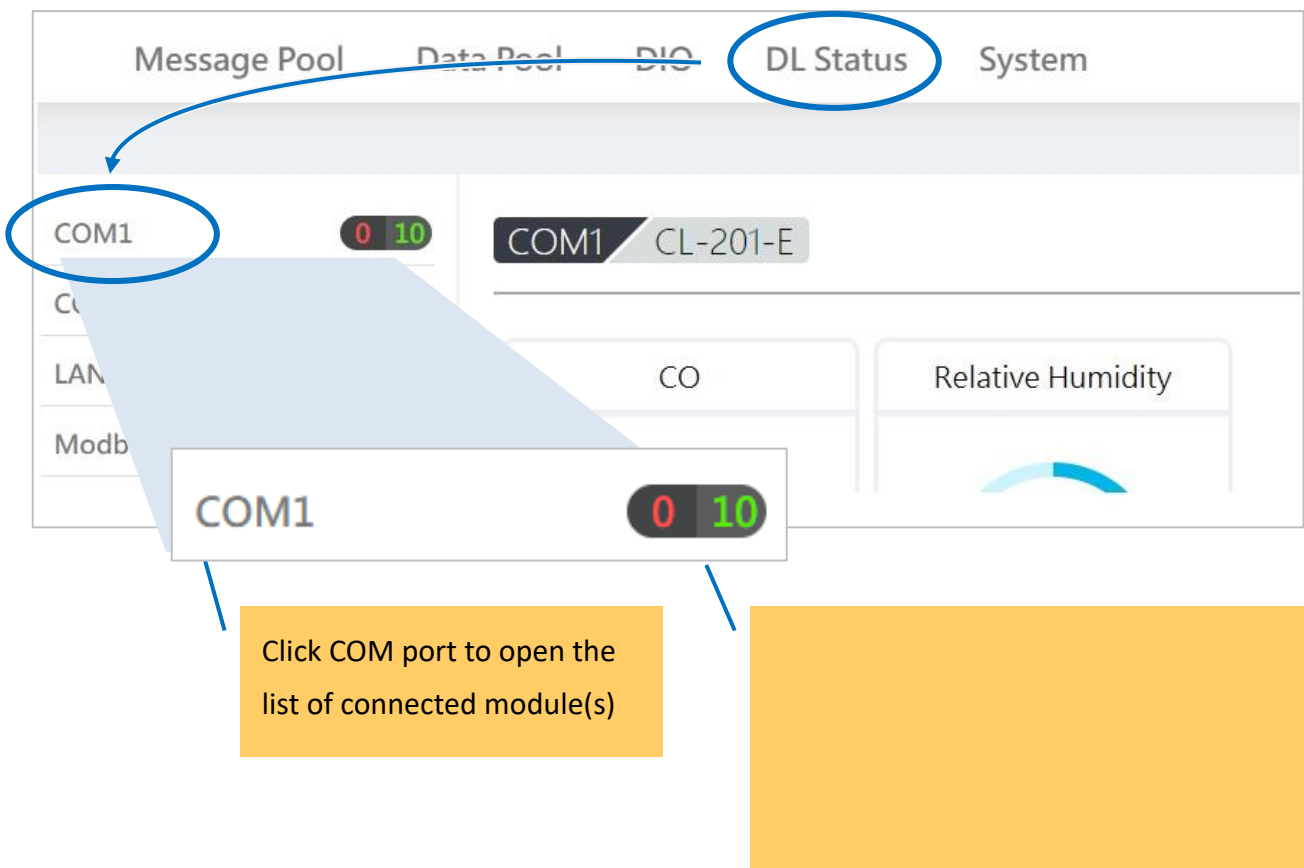



8. Click the module name in list to view the real-time data from the module.

The screenshot displays the iKAN Series Display interface. On the left, a list of modules is shown under the heading 'COM1'. The module 'CL-202-E(193)' is selected and highlighted with a blue circle. On the right, the real-time data for this module is displayed. The data is presented in two panels: 'CO2' showing a value of 734 ppm with a progress bar below it, and 'Relative Humidity' showing a value of 56.25% with a circular gauge. A callout box at the top right explains the interface elements: 'COM1: connection interface' and 'CL-202-E: Module name'. Another callout box at the bottom center points to the data area, labeled 'Real-time data'.

Module Name	CO2 (ppm)	Relative Humidity (%)
CL-201-E(192)		
<b>CL-202-E(193)</b>	<b>734</b>	<b>56.25</b>
CL-203-E(194)		
CL-204-E(195)		
CL-212(196)		
CL-211(197)		
CL-212-E(198)		
CL-213(199)		
CL-208-E(200)		
CL-213-E(201)		

☑ **Checking the variable symbol for measured items**

9. Click **Modbus Table** to view the table of contents for measurement items, their Modbus addresses and the variable symbols used to be inserted into a message.

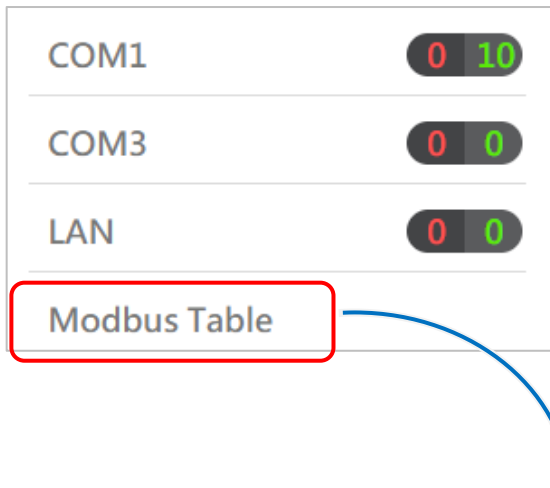

Modbus Register Table for DL Value (3xxxx)



Address (Base 0)	Description	Message Pool Symbol
518	CL-202-E(COM1->ID:193)CO2	%y518
519	CL-202-E(COM1->ID:193)Relative Humidity	%y519
520	CL-202-E(COM1->ID:193)Temperature (°C)	%y520
521	CL-202-E(COM1->ID:193)Temperature (°F)	%y521
522	CL-202-E(COM1->ID:193)Dew Point Temperature	%y522

Labels with arrows pointing to the table:





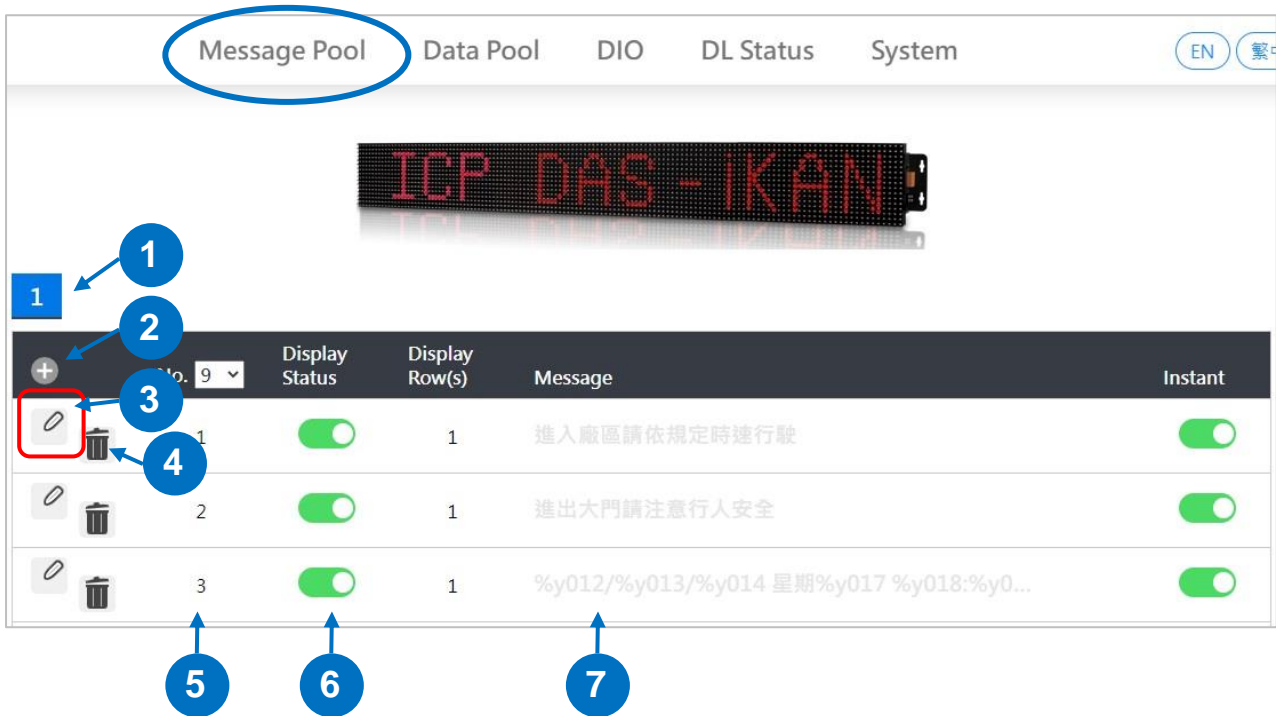

- Modbus address (points to the 'Address' column)
- Variable symbol (points to the 'Message Pool Symbol' column)

A large yellow rectangular box is positioned below the table, with an arrow pointing upwards to the 'Description' column.

**Editing a message with a variable symbol**

10. Click the  icon to add a message and click the  icon to edit the message on the Message Pool page.



Item	Description
1	 The page number in Message Pool
2	 The icon for adding a message
3	 The icon for editing a message
4	 Clicks the icon to delete a message
5	Message number
6	 To Enable/  Disable the display of a message
7	The content of a message

11. Insert the desired variable symbol into a message such as **CO2: %y518 ppm** and click the Update button.

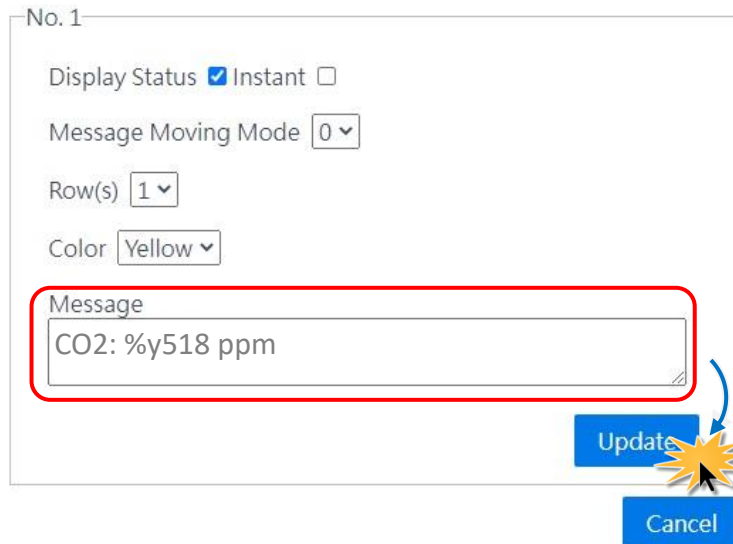

The image shows a configuration dialog box titled "No. 1". It contains several settings: "Display Status" with a checked "Instant" checkbox and an unchecked checkbox; "Message Moving Mode" set to "0"; "Row(s)" set to "1"; and "Color" set to "Yellow". A text input field labeled "Message" contains the text "CO2: %y518 ppm" and is highlighted with a red border. Below the input field are two buttons: "Update" and "Cancel". A mouse cursor is pointing at the "Update" button, and a yellow starburst graphic is positioned over it, indicating a click action.

12. Check the message is correctly displayed with measured value from the CL/DL series module.



The image shows a black rectangular display area containing the text "CO2: 472 ppm" in yellow font.

# Appendix. Variable Types and Modbus Register Map

## Variable Types

The iKAN series device allows data related to items such as the Ethernet configuration, the RTC value, and other information, to be inserted into a message as a system variable.

The format for using a system variable in a message has a length of 5 bytes, as follows:

1	2	3 to 5		
Delimiter Character	Variable Type	Modbus Address: 3-digit decimal number		
%	y: System variable	X	X	X
	b: Coil			
	u: Unsigned integer (0 to 65535)			
	i: Signed integer (-32768 to 32767)			
	f: Float (-3.4E+38 to +3.4E+38)			

The valid range for each type of variable is:

Variable Type	Range
Coil Variables	%b000 to %b039
Integer Variables	%u000 to %u063
	%i000 to %i063
Float Variables	%f128 to %f254
System Variables	%y000 to %y026

**Modbus Register Map**

**Coil-type variables (0xxxx, 0 based)**

Modbus Address		Length	Description	Value Range	Attribute
Decimal	Hex.				
00000 : 00039	0000 : 0027	40	Coil-type variables	-	R/W
00100 : 00227	0064 : 00E3	128	Enables or disables the display of common messages 0 to 127.	0: Disabled 1: Enabled	R/W

## System variables (3xxxx, 0 based)

Modbus Address		Length	Description	Value Range	Attribute
Decimal	Hex.				
30000 : 30003	0000 : 0003	4	The IP address for the iKAN series device	0 to 255	R
30004 : 30007	0004 : 0007	4	The Mask address for the iKAN series device	0 to 255	R
30008 : 30011	0008 : 000B	4	The Gateway address for the iKAN series device	0 to 255	R
30012	000C	1	Year	0 to 9999	R
30013	000D	1	Month	1 to 12	R
30014	000E	1	Day	1 to 31	R
30015	000F	1	Abbreviated day of the week: SUN, MON, TUE, WED, THU, FRI, SAT	0 to 6	R
30016	0010	1	Day of the week: Sunday, Monday, Tuesday, Wednesday, Thursday, Friday, Saturday	0 to 6	R
30017	0011	1	Day of the week in Chinese characters: 日、一、二、三、四、五、六	0 to 6	R
30018	0012	1	Hours (24-hour format)	0 to 23	R
30019	0013	1	Minutes	0 to 59	R
30020	0014	1	Seconds	0 to 59	R

### Integer-type variables/Float-type variables/misc. (4xxxx, 0 based)

Modbus Address		Length	Description	Value Range	Attribute
Decimal	Hex.				
40000 : 40063	0000 : 003F	64	Integer-type variables	0 to 65535	R/W
40128 : 40255	0080 : 00FF	64	Float-type variables	3.4E+38 to +3.4E+38	R/W
40384 : 40447	0180 : 01BF	64	Data mapping arguments: Source Low	0 to 65535	R/W
40512 : 40475	0200 : 023F	64	Data mapping arguments: Source High	0 to 65535	R/W
40640 : 40703	0280 : 02BF	64	Data mapping arguments: Target Low	0 to 65535	R/W
40768 : 40831	0300 : 033F	64	Data mapping arguments: Target High	0 to 65535	R/W
40896 : 40959	0380 : 03BF	64	Data mapping arguments: Decimal Places	0 to 2	R/W
41024 : 41087	0400 : 043F	64	Decimal Places for float-type variables	1 to 3	R/W



Modbus Address		Length	Description	Value Range	Attribute
Decimal	Hex.				
41408 : 41535	0580 : 05FF	128	Color for common messages 0 to 127 in the first row.	1: Blue 2: Green 3: Sky Blue 4: Red 5: Purple 6: Yellow 7: White 8: Random	R/W
41600	0640	1	Brightness for the display, a smaller number means a brighter screen	0 to 4	R/W
41601	0641	1	Message scrolling speed. A smaller value denotes a higher speed.	0 to 9	R/W
41602	0642	1	Modbus Station ID	1 to 254	R/W
41604	0644	1	Modbus TCP Slave port	0 to 65535	R/W
41612	0652	1	The response timeout value for Modbus TCP communication	0 to 65535	R/W
41613	0653	1	The delay between polls for Modbus TCP communication	0 to 65535	R/W
41632 : 41759	0660 : 06DF	128	The priority for messages 0 to 127	0: Common 1: Instant	R/W
41800 : 41831	0708 : 0727	32	The contents of ASCII string 0	ASCII	R/W
41832 : 41863	0728 : 0747	32	The contents of ASCII string 1	ASCII	R/W
41864 : 41895	0748 : 0767	32	The contents of ASCII string 2	ASCII	R/W

Modbus Address		Length	Description	Value Range	Attribute
Decimal	Hex.				
41896 : 41927	0768 : 0787	32	The contents of ASCII string 3	ASCII	R/W
41928 : 41959	0788 : 07A7	32	The contents of ASCII string 4	ASCII	R/W
41960 : 41991	07A8 : 07C7	32	The contents of ASCII string 5	ASCII	R/W
41992 : 42023	07C8 : 07E7	32	The contents of ASCII string 6	ASCII	R/W
42024 : 42055	07E8 : 0808	32	The contents of ASCII string 7	ASCII	R/W
42100 : 42227	0834 : 08B3	128	The color of messages 0 to 127 on the second row.	1: Blue 2: Green 3: Sky Blue 4: Red 5: Purple 6: Yellow 7: White 8: Random	R/W
42300 : 42427	08FC : 097B	128	The message moving type for messages 0 to 127	0 to 3	R/W

Modbus Address		Length	Description	Value Range	Attribute
Decimal	Hex.				
42500 : 42539	08FC : 09EB	40	The color for coil variables 0 to 39	1: Blue 2: Green 3: Sky Blue	R/W
42700 : 42763	0A8C : 0ACB	64	The color for integer variables 0 to 63	4: Red 5: Purple 6: Yellow	R/W
42700 : 42763	0A8C : 0ACB	64	The color for float variables 0 to 63	7: White 8: Random	R/W

## Revision History

The table below shows the revision history.

Revision	Date	Description
1.0.1	September 2019	Initial issue
1.0.2	February 2021	Modify the workflow of iKAN updates in chapter 5.
1.1.0	December 2022	Description update for user interface and new functions.
1.1.1	June 2024	Modify the valid range of values for characters in ASCII and Unicode strings.