



DL-1050
DL-1051
DL-1052
DL-1053
DL-1054
DL-1055
DL-1056
DL-1057
DL-1058

O₂/CO/CO₂/HCHO/TVOC/NH₃/H₂S/Temperature/
 Humidity/Dew Point Data Logger Module

Features

- Able to record O₂, CO, CO₂, HCHO, TVOC, NH₃, H₂S, Temperature, Humidity, and Dew Point Measurements
- Non-dispersive Infrared (NDIR) CO₂ Sensor
- Electrochemical Sensor
- Up to 180,000 records with date and time stamps
- Web-based Configuration Interface
- Simple and Powerful Software Utility, iOS APP and Android App Included
- Supports the DCON, Modbus RTU/TCP, and MQTT Protocols
- Includes RS-485/Ethernet/PoE Communication Interfaces
- Relay Output for Audible/Visual Alarm or IAQ Device Control
- Includes redundant power inputs: PoE (IEEE 802.3af, Class 1) and DC input
- IP 43 Protection Approval



Introduction

The DL-1050 is a series of O₂ and gas measurement module that measures oxygen gas (O₂) in air. In addition, various fume concentrations related to human health can also be measured. For example: CO/CO₂ DL-1000 can record data and send alarm when concentration is too high. It can be used to record O₂, CO, CO₂, Temperature, Point information, including date and time stamps, and are able to store up to 180,000downloadable records. Real-time data can be accessed from the DL-1000 series Data Logger from anywhere and at any time using the free Windows software, the iOS App or the Android App, as long as they are connected to the same local network as the Data Logger. Support is provided for popular industrial protocols such as DCON, Modbus RTU, and Modbus TCP, as well as the emerging machine-to-machine (M2M)/IoT (Internet of Things) connectivity protocol-MQTT. The DL-1000 series Data Logger can be connected via widely used communication interfaces including RS-485, Ethernet and PoE, meaning that the device can be easily integrated into existing HMI or SCADA systems, and is easy to be maintained in a distributed control system. The DL-1000 series is designed for industrial applications in harsh environments that provides IP43 grade protection approval. The rugged RJ-45 ensures tight, robust connections, and guarantees reliable operation, even for applications that are subject to high vibration and shock.

Multi-platform Remote Access Software

Real-time data from the DL-300 Data Logger can be accessed from anywhere and at any time using the DL300 Utility, the iOS or Android App, or via a regular web browser, as long as they are connected to the same local network as the Data Logger.



Supports the MQTT Protocol for IoT Applications

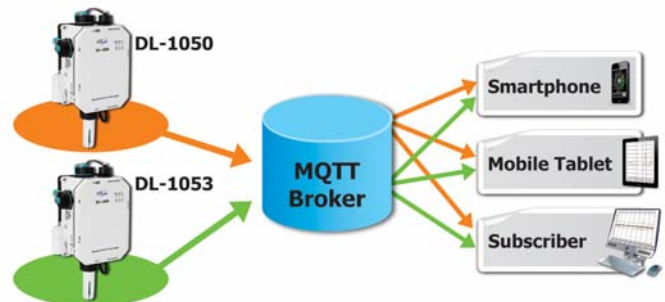

Replaceable Filter Patch (FLT-C001)

Generally, the PM_{2.5} measuring sensor on the market is usually installed in outdoor applications. Because the outdoor air is quite dusty, the measuring channel of PM_{2.5} sensor is easily clogged by aerosol, resulting in continued alarms for the heavy concentration. Due to the error data from the clogged sensor, this module is returned to the factory for repair. Downtime during the repair period often causes significant cost and losses. In order to solve this problem, ICP DAS design the CL-200 series and DL-1000 series with replaceable patch, FLT-C001, which makes it easy for users to replace them without uninstall the devices. Cost of repair and time can be reduced by this innovated mechanical design.



Simple and powerful utility

The DL300 Utility can be used to configure the modules, monitor real-time data, group DL-1000 modules so that the status of distribution groups can be viewed and managed. The utility also allows the log data to be downloaded and exported to a .CSV file that can then be imported into any industry-standard software or spread sheet for analysis.

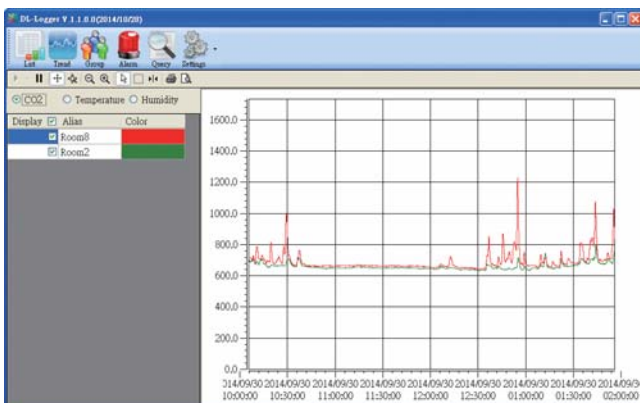

Applications

Intelligent Street Lighting in Smart City

In smart city applications, smart street lights integrate various communication technologies and are no longer illumination only. The high-density construction of streetlights have become one of the most important sources of government collecting road information in recent years. DL-1000 series products, with standard industrial communication protocol Modbus RTU/TCP, can integrate with smart streetlights to achieve outdoor air quality monitoring such as: O₃, CO, CO₂, SO₂, NO₂, TVOC, HCHO, and Particle Matter 1/2.5/10. Due to these aerosol could accumulate around the sensor and would cause error record after using for a period, DL-1000 support replaceable dust filter patch to easily change the patches inside the filter hood rather than uninstall the device.

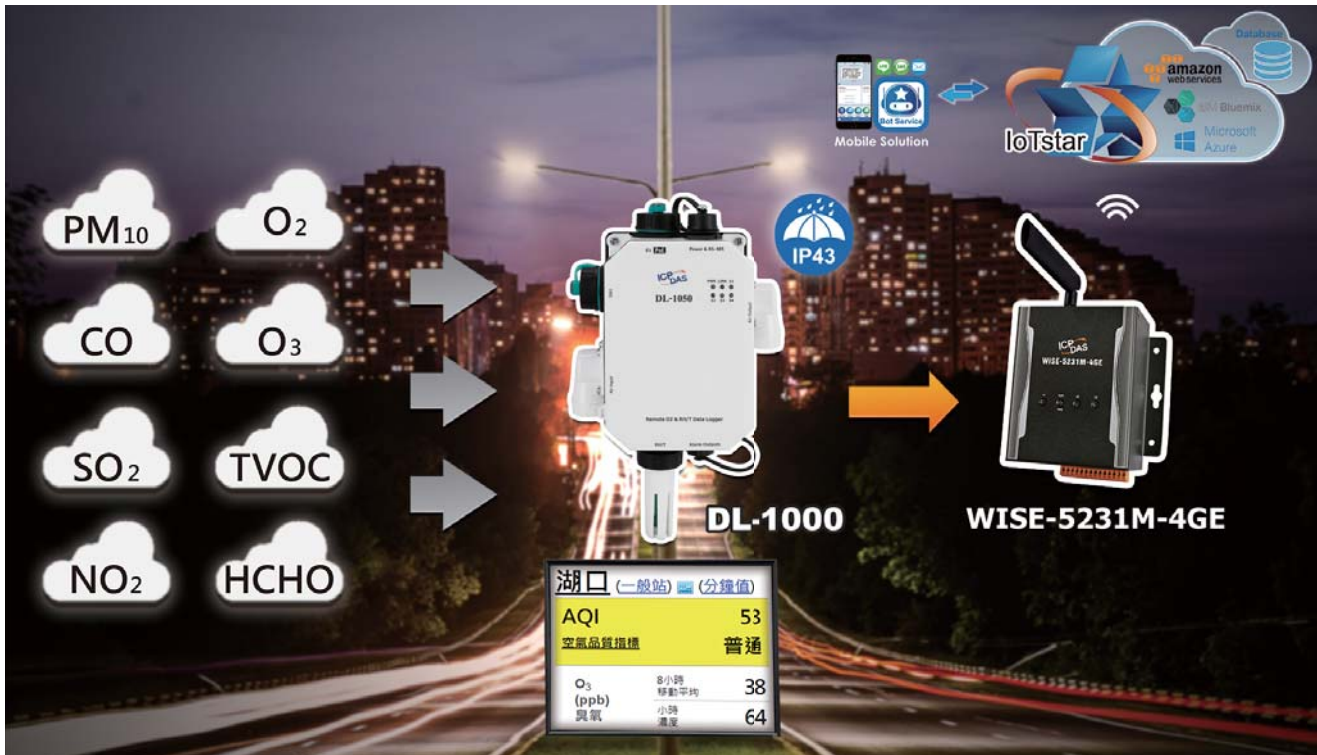

Outdoor Mobile Air Quality Detection Application

In developed countries, the Air Quality detection, statistics and evaluation is the most for improvement. In a vast area, it can only rely on the vehicle moving to record status of air quality, and to offline extract these and send back sorting out.

ICP DAS DL-1000 series can integrate with our 3G/ 4G controllers to transmit data back to control center wirelessly.



Factory Gas Detection Application

In some factories, H₂S is one of the harmful gases. Due to the colorless and odorless are two characteristics quite hard to find or feel it, sometimes the workers inside the factory get injured inevitably. Joint liability from the injury brings the company a massive fines.

DL-1026 H₂S detector module can put in the spot. It equip with standard industrial protocols and with high flexible to integrate information from devices and transmit back to control center. When the concentration of gas is too high, DL-1026 can also send alarm signals to inform relative person to evacuate people there.



DL-10



Particle Matter Sensor

- 1 : PM2.5
- 2 : PM2.5/1/10 + Particle
- 3 : PM2.5/1/10 + Particle + CO+CO₂
- 5 : O₂

PM Size :
0.3µm, 0.5µm,
1µm, 2.5µm,
5µm, 10µm



Types of Gas Sensor

- 0 : -
- 1 : CO
- 2 : CO₂
- 3 : CO+CO₂
- 4 : HCHO + TVOC
- 5 : NH₃
- 6 : N₂S
- 7 : HCHO
- 8 : TVOC



Communication

- : Ethernet/PoE
- : Wi-Fi

DL-10xx Series		Gas Sensor								Communication
Basic Type	Wi-Fi	Particle	Gas Sensor							
		O ₂	CO	CO ₂	HCHO	NH ₃	H ₂ S	TVOC	T & RH	
DL-1050	DL-1050-WF	Yes	-	-	-	-	-	-	Yes	Basic type: RS-485 + Ethernet/PoE WF type: Wi-Fi + RS-485 + Ethernet/PoE
DL-1051	DL-1051-WF	Yes	Yes	-	-	-	-	-	Yes	
DL-1052	DL-1052-WF	Yes	-	Yes	-	-	-	-	Yes	
DL-1053	DL-1053-WF	Yes	Yes	Yes	-	-	-	-	Yes	
DL-1054	DL-1054-WF	Yes	-	-	Yes	-	-	Yes	Yes	
DL-1055	DL-1055-WF	Yes	-	-	-	Yes	-	-	Yes	
DL-1056	DL-1056-WF	Yes	-	-	-	-	Yes	-	Yes	
DL-1057	DL-1057-WF	Yes	-	-	Yes	-	-	-	Yes	
DL-1058	DL-1058-WF	Yes	-	-	-	-	-	Yes	Yes	

System Specifications

Power	Powered from Terminal Block		+12 to +48 VDC
	Powered from PoE		IEEE 802.3af, Class 1 (48 V)
	Power Consumption	PoE	2.7 W MAX
		Non-PoE	2.5 W MAX
System	Alarm		PM1/PM2.5/PM10/O2/CO/CO2/HCHO/TVOC/NH3/H2S/RH/Temperature
	Real Time Clock		Yes
	Data Logger		Yes, up to 180,000 records
	Relay Output		PhotoMos Relay × 4, 100 VDC @ 1 A
LED Indicators	PWR		Green for normal operation
	Link		Green for the Ethernet-linked
	S1 ~ S4		Red for an alarm condition
Environment	Operating Temperature		-20 to +50°C
	Storage Temperature		-30 to +75°C
	Humidity		10 to 90% RH, Non-condensing
	Protection Class		IP43
Communication	RS-485 Port		Baud Rate = 1200 ~ 115200 bps
	Ethernet Port		10/100 Base-TX, 8-Pin RJ-45 x1(Auto-negotiating, Auto-MDI/MDIX, LED indicators)
	Security		IP filter (whitelist) and Password (web)
	Protocol		Modbus/RTU(RS-485), Modbus TCP(Ethernet) and MQTT(Ethernet)
	Dual Watchdog		Yes, Module (2.3 sec), Communication (Programmable)
Mechanical	Installation		DIN-Rail or Wall Mounting
	Dimensions (W x L x H)		130 mm x 211 mm x 70 mm

I/O Specifications

Type of Sensor	Range	Resolution	Accuracy	Response Time	Warm-up Time	Life Time	Re-calibratable	Offset programmable	Replaceable (RMA)
O2	0~25%	0.01%	2% of FSR	< 30 secs (typical)	120 seconds	> 5 years	No	Yes	Yes
CO	0 to 1000 ppm (Electrochemical)	1 ppm	±5% of measured value	30 seconds	60 seconds	5 years	No	Yes	Yes
CO2	0 ~ 9999 ppm (NDIR)	1 ppm	±30 ppm ±3% of measured value	120 seconds	300 seconds	15 years	Yes. (Note)	Yes	Yes
HCHO	0 ppb to 2000 ppb (Electrochemical)	1 ppb	0 ~ 300ppb : ±30ppb > 300ppb : ±10%	≤60 seconds	180 seconds	3 years	No	Yes	Yes
TVOC	0 ppb to 60000 ppb (MEMS Metal Oxide)	1 ppb	±15%	60 seconds	180 seconds	5 years	No	Yes	Yes
NH3	0 to 100 ppm (Electrochemical)	1 ppm	±5% of measured value	< 40 seconds	60 seconds	2 years	No	Yes	Yes
H2S	0 to 100 ppm (Electrochemical)	1 ppm	±5% of measured value	< 30 seconds	60 seconds	2 years	No	Yes	Yes
Temperature	-20 to +50°C	0.1°C	±0.6°C	-	-	10 years	No	Yes	Yes
Relative Humidity	0 to 100% RH, Non-condensing	0.1% RH, Non-condensing	±5% RH, Non-condensing	-	-	10 years	No	Yes	Yes
Dew Point	Calculated using temperature and relative humidity	0.1°C	-	-	-	10 years	No	Yes	Yes

Note: Customers can perform ABC (Automatic Baseline Calibration) by themselves.

Particle	
Sizes	0.3µm, 0.5µm,,1µm, 2.5µm,,5µm, 10µm

Appearance

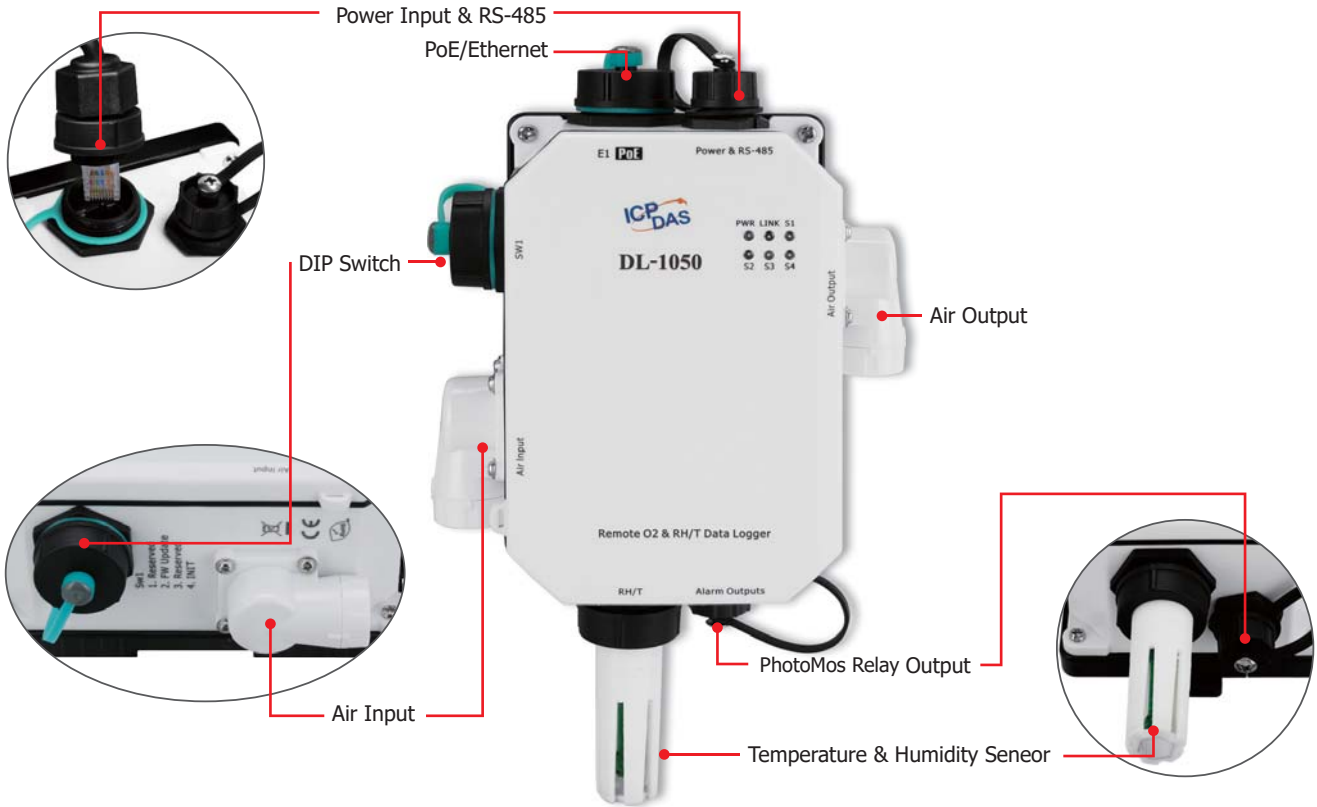

Dimensions (Units: mm)

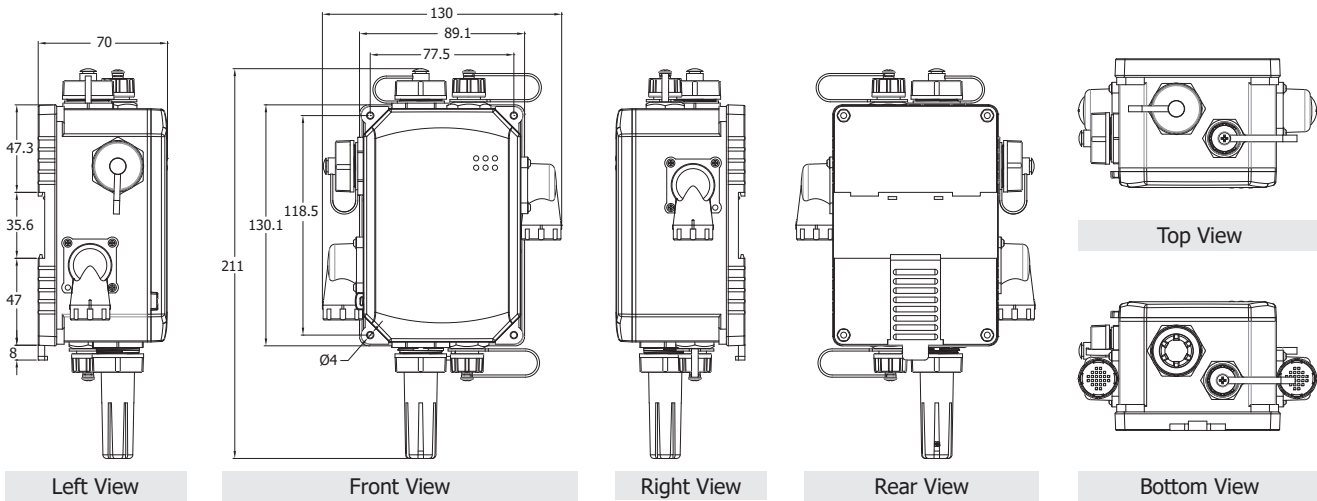

IP65 Ethernet Cap with Tether

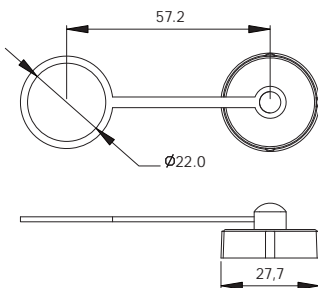

IP65 Ethernet Plug

Cable Dia:
Max. 7.0 mm
Min. 5.5 mm

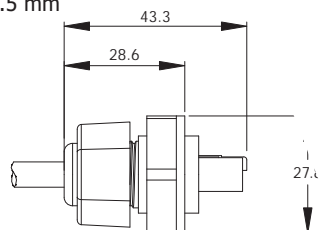

IP65 PWR Plug

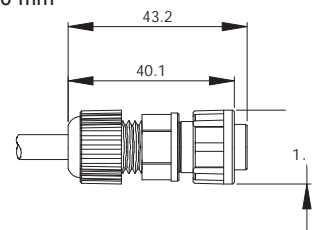

Cable Dia:
Max. 6.5 mm
Min. 5.0 mm



Ordering Information

DL-1050 CR	Remote O2/Temperature/Humidity/Dew Point Data Logger with Ethernet/RS-485 and PoE (RoHS)
DL-1051 CR	Remote O2/CO/Temperature/Humidity/Dew Point Data Logger with Ethernet/RS-485 and PoE (RoHS)
DL-1052 CR	Remote O2/CO2/Temperature/Humidity/Dew Point Data Logger with Ethernet/RS-485 and PoE (RoHS)
DL-1053 CR	Remote O2/CO/CO2/Temperature/Humidity/Dew Point Data Logger with Ethernet/RS-485 and PoE (RoHS)
DL-1054 CR	Remote O2/HCHO/TVOC/Temperature/Humidity/Dew Point Data Logger with Ethernet/RS-485 and PoE (RoHS)
DL-1055 CR	Remote O2/NH3/Temperature/Humidity/Dew Point Data Logger with Ethernet/RS-485 and PoE (RoHS)
DL-1056 CR	Remote O2/H2S/Temperature/Humidity/Dew Point Data Logger with Ethernet/RS-485 and PoE (RoHS)
DL-1057 CR	Remote O2/HCHO/Temperature/Humidity/Dew Point Data Logger with Ethernet/RS-485 and PoE (RoHS)
DL-1058 CR	Remote O2/TVOC/Temperature/Humidity/Dew Point Data Logger with Ethernet/RS-485 and PoE (RoHS)

Accessories

Mode Name	NS-205-IP67	NS-208PSE-IP67	NS-208-IP67
Picture			
PoE	–	802.3af x 8	–
Input Voltage Range	+10 VDC ~ +30 VDC (1 kV Isolated)	+46 VDC ~ +53 VDC	+12 VDC ~ +53 VDC
Installation	Wall Mounting	Wall Mounting	
Dimensions (W x L x H)(Unit: mm)	85 x 76 x 137	190 x 155 x 104	

FLT-C001	Replaceable Filter Patch (Circle) (1 Pack 4 Patches) (RoHS) Size: (OD :16, ID:12)mm
----------	--

IP67 RJ-45 Plug	IP67 Power Plug	Cap with Tether	Replaceable Filter Patch
			
4SASO-001	4SIO1K0000013	4SASO-0004	FLT-C001