

User Manual

Version 2.0.0, Aug. 2023

ECAN-240-FD

(Modbus TCP to 2-port CAN FD Gateway)



Table of Contents

1. INTRODUCTION	6
1.1. FEATURES	7
1.2. APPLICATIONS	7
1.3. WEB SERVER TECHNOLOGY	8
2. HARDWARE INFORMATION	9
2.1. SPECIFICATIONS	9
2.2. APPEARANCE.....	10
2.3. DIMENSIONS	13
2.4. TERMINAL RESISTOR NOTES FOR CAN INTERFACE.....	14
3. GETTING STARTED FOR ECAN-240-FD	15
3.1. CONNECTING THE POWER SUPPLY AND THE HOST PC.....	15
3.2. CONFIGURING THE NETWORK SETTINGS	17
3.3. CONFIGURING THE CAN PORT.....	19
3.4. SELF-TEST	21
4. WEB CONFIGURATION	24
4.1. LOGGING IN TO THE ECAN-240-FD WEB SERVER	24
4.2. HOME PAGE.....	26
4.3. CAN PORT PAGE	27
4.3.1. <i>Port1/2 Settings</i>	27
4.3.2. <i>Specific CAN ID Settings</i>	30
4.4. NETWORK PAGE.....	31
4.4.1. <i>IP Address Settings</i>	31
4.4.2. <i>General Settings</i>	34
4.4.3. <i>Restore Factory Defaults</i>	37
4.4.4. <i>Import/Export Settings</i>	39
4.5. FILTER PAGE	40
4.6. MONITOR PAGE	42
4.7. PASSWORD PAGE	44
4.8. LOGOUT PAGE	45
5. CGI CONFIGURATION.....	46
5.1. CGI URL SYNTAX.....	46

5.2. CGI COMMAND LIST.....	47
6. MODBUS INFORMATION	52
6.1. MODBUS/CAN MAPPING TABLE	52
6.1.1 <i>Input Data Area</i>	53
6.1.1.1 CAN Rx Message Format.....	54
6.1.1.2 CAN Rx FIFO Address	55
6.1.1.3 CAN Status Address	56
6.1.1.4 CAN Rx Buffer Address.....	58
6.1.1.5 Others	61
6.1.2 <i>Output Data Area</i>	62
6.1.2.1 CAN Tx Message Format	63
6.1.2.2 CAN Tx FIFO Address.....	64
6.1.2.3 Others	65
6.2. MODBUS/CAN FD MAPPING TABLE	66
6.2.1 <i>Input Data Area</i>	67
6.2.1.1 CAN FD Rx Message Format	68
6.2.1.2 CAN FD Rx FIFO Address	70
6.2.1.3 CAN Status Address	71
6.2.1.4 CAN FD Rx Buffer Address.....	73
6.2.1.5 Others	76
6.2.2 <i>Output Data Area</i>	77
6.2.2.1 CAN FD Tx Message Format.....	78
6.2.2.2 CAN FD Tx FIFO Address.....	80
6.2.2.3 Others	81
7. ETHERNET COMMAND INFORMATION	82
7.1. ETHERNET/CAN COMMAND.....	83
7.2. ETHERNET/CAN FD COMMAND.....	84
7.2.1 <i>Command Header Field</i>	84
7.2.2 <i>Command Data Field</i>	86
7.2.3 <i>Ethernet command Examples</i>	88
8. TYPICAL APPLICATIONS.....	94
8.1. MODBUS TCP SERVER APPLICATION.....	94
8.2. TCP/UDP TRANSPARENT APPLICATION.....	95
8.3. CAN PAIR CONNECTION APPLICATION.....	96
APPENDIX A. TROUBLESHOOTING.....	97

A.1.	HOW DO I RESTORE THE WEB PASSWORD FOR THE MODULE TO THE FACTORY DEFAULT PASSWORD?	97
APPENDIX B. GLOSSARY		99
1.	ARP (ADDRESS RESOLUTION PROTOCOL)	99
2.	RARP (REVERSE ADDRESS RESOLUTION PROTOCOL)	99
3.	CLIENTS AND SERVERS	100
4.	ETHERNET	100
5.	FIRMWARE	100
6.	ICMP (INTERNET CONTROL MESSAGE PROTOCOL)	100
7.	INTERNET	100
8.	IP (INTERNET PROTOCOL) ADDRESS	101
9.	SUBNET MASK	101
10.	GATEWAY	101
11.	MAC (MEDIA ACCESS CONTROL) ADDRESS	101
12.	PACKET	101
13.	PING	102
14.	SOCKET	102
15.	TCP (TRANSMISSION CONTROL PROTOCOL)	102
16.	TCP/IP	102
17.	UDP (USER DATAGRAM PROTOCOL)	102
APPENDIX C. VALID DATA PHASE BIT RATE OF CAN FD		103
APPENDIX D. REVISION HISTORY		105

Important Information

Warranty

All products manufactured by ICP DAS are under warranty regarding defective materials for a period of one year, beginning from the date of delivery to the original purchaser.

Warning

ICP DAS assumes no liability for any damage resulting from the use of this product. ICP DAS reserves the right to change this manual at any time without notice. The information furnished by ICP DAS is believed to be accurate and reliable. However, no responsibility is assumed by ICP DAS for its use, not for any infringements of patents or other rights of third parties resulting from its use.

Copyright

Copyright © 2023 by ICP DAS Co., Ltd. All rights are reserved.

Trademark

Names are used for identification purpose only and may be registered trademarks of their respective companies.

Contact us

If you encounter any problems while operating this device, feel free to contact us via mail at: service@icpdas.com.

1. Introduction

The IoT (Internet of Things) has been a much discussed topic in recent years. Using the IoT concept, it is easy to integrate the environment of heterogeneous network and let all of the things into be digitized making life more convenient. In order to provide additional access to IoT applications related to industry based on the CAN bus, ICPDAS has developed a new Ethernet product, the ECAN-240-FD. The ECAN-240-FD module is a Modbus TCP to 2-port CAN FD (CAN with Flexible Data-Rate) Gateway. As its functionality, that provides communications via the Ethernet based on the Modbus TCP industrial protocol, meaning that the module can be easily integrated with an industrial network. The ECAN-240-FD module includes two CAN bus interfaces, meaning that more various CAN applications can be supported

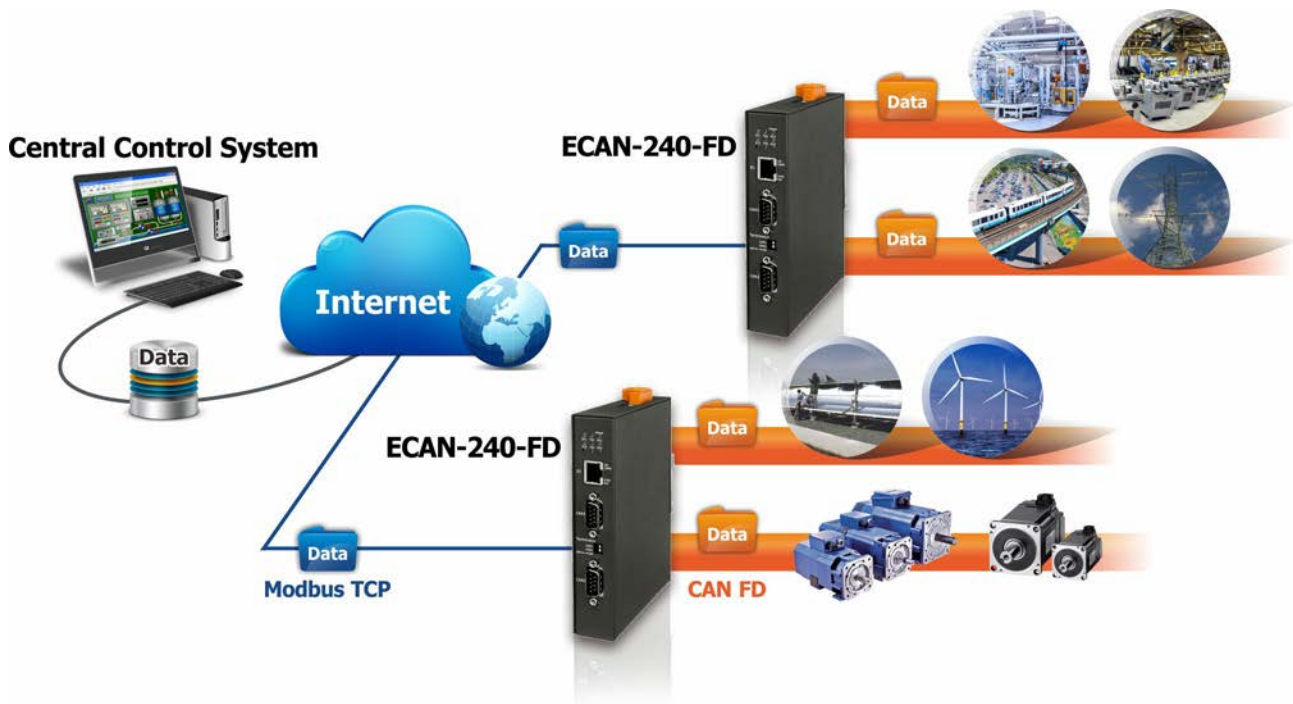

1.1. Features

Hardware

- ◆ Compatible with the ISO 11898-2 standard
- ◆ Compatible with CAN specification 2.0 A/B and FD
- ◆ CAN FD support for ISO and Non-ISO (Bosch) standards switchable
- ◆ CAN FD bit rates for data field from 100 kbps to 10000 kbps
- ◆ CAN bit rates from 10 kbps to 1000 kbps
- ◆ Built-in DIP-switch to enable/disable the CAN bus terminal resistor
- ◆ Two CAN bus interfaces with 9 pin D-sub connector

Software

- ◆ Web configuration
- ◆ CAN bus ID filter
- ◆ Modbus TCP server function
- ◆ TCP/UDP to CAN transparent communication
- ◆ CAN pair connection via UDP communication
- ◆ UDP responder for device discovery
- ◆ Static IP or DHCP network configuration

1.2. Applications

- ◆ Control System
- ◆ Building Automation
- ◆ Factory Automation
- ◆ Distributed data acquisition



1.3. Web Server Technology

Web server technology enables the ECAN-240-FD to be configured via a standard web browser interface, e.g. Google Chrome, Internet Explorer, or Firefox, etc. This means that it is easy to check the configuration of the ECAN-240-FD via an Ethernet network without needing to install any other software tools, thereby reducing the learning curve required for maintaining the device.

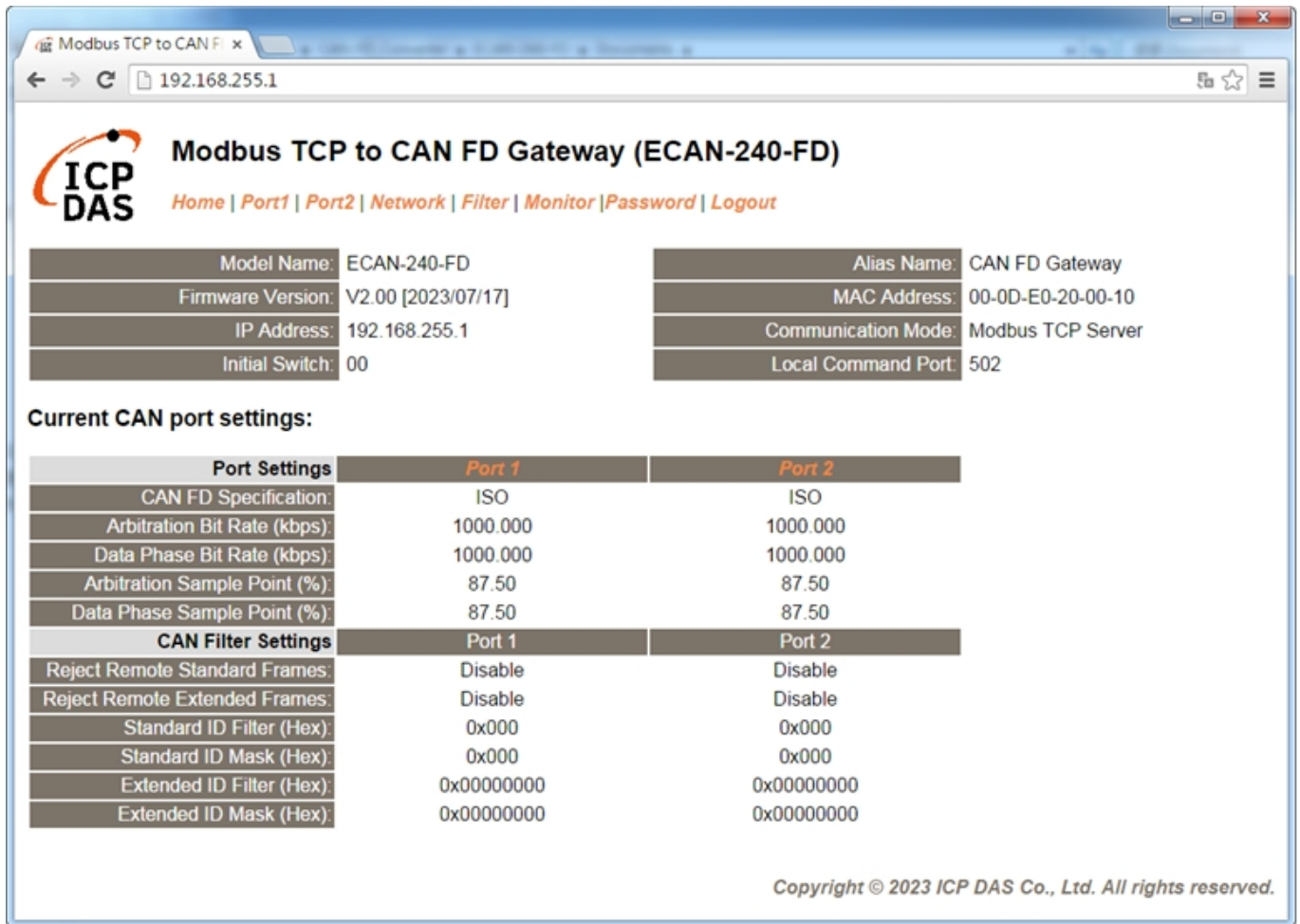



2. Hardware Information

This chapter provides a detailed description of the front panel, the hardware specifications and the dimensions for the ECAN-240-FD module.

2.1. Specifications

CAN Bus Interface	
Channels	2
Connector	9-pin D-sub male x 2
Transmission Speed	CAN bit rates: 10 ~ 1000 kbps, CAN FD bit rates for data field: 100 ~ 10000 kbps
Terminal Resistor	DIP switch for the 120 Ω terminal resistor
Isolation	3 kV VDC for DC to DC, 2500 Vrms for photo couple
Specification	ISO 11898-2, CAN 2.0 A/B and FD
Ethernet Interface	
Ethernet	10/100 Base-TX, 8-pin RJ-45 x 1, (Auto-negotiating, Auto-MDI/MDIX, LED indicator)
Protocol	Modbus TCP, TCP, UDP, HTTP, BOOTP, TFTP
LED Indicators	
Status	1 x Power status, 3 x CAN1 status, 3 x CAN2 status
Power	
Power Supply	Unregulated +10 ~ +30 VDC
Power Consumption	0.05A @ 24V _{DC}
Mechanical	
Installation	DIN-Rail
Casing	Metal
Dimension (mm)	122.0 x 160.0 x 28.0 (W x L x H)
Environment	
Operating Temperature	-25 °C ~ +75 °C
Storage Temperature	-30 °C ~ +80 °C
Relative Humidity	10 ~ 90% RH, Non-condensing

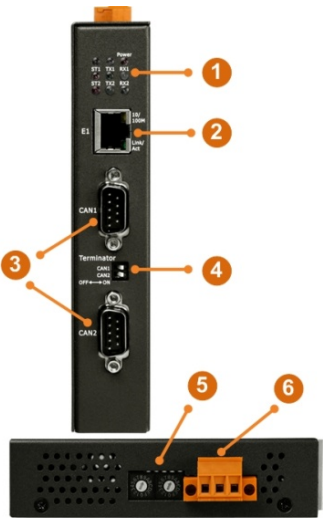
2.2. Appearance

Front View	1. LED indicator																								
 <p>The image shows the front view of the ECAN-240-FD module. It is a vertical black PCB with several ports and components. Callout 1 points to the Power LED indicator. Callout 2 points to the E1 Ethernet port. Callout 3 points to the CAN1 port. Callout 4 points to the Terminator switch. Callout 5 points to the CAN2 port. Callout 6 points to the power connector on the bottom of the module.</p>	<p>Once power is supplied to the ECAN-240-FD module, the LED indicator will illuminate. An overview of the LED functions is given below:</p>  <table border="1" data-bbox="526 851 1468 1724"> <thead> <tr> <th>LED</th> <th>Color</th> <th>Description</th> </tr> </thead> <tbody> <tr> <td>Power</td> <td>Red</td> <td>When power on the ECAN-240-FD, this LED is turned on.</td> </tr> <tr> <td>ST1</td> <td>Red</td> <td>If the ECAN-240-FD detects the CAN error-warning, error-passive and bus-off status on the CAN1 bus, this LED flashes once per 100 ms.</td> </tr> <tr> <td>ST2</td> <td>Red</td> <td>If the ECAN-240-FD detects the CAN error-warning, error-passive and bus-off status on the CAN2 bus, this LED flashes once per 100 ms.</td> </tr> <tr> <td>TX1</td> <td>Green</td> <td>When the ECAN-240-FD transmits one CAN/CAN FD message to CAN1 bus, this LED flashes once.</td> </tr> <tr> <td>RX1</td> <td>Green</td> <td>When the ECAN-240-FD receives one CAN/CAN FD message from CAN1 bus, this LED flashes once.</td> </tr> <tr> <td>TX2</td> <td>Green</td> <td>When the ECAN-240-FD transmits one CAN/CAN FD message to CAN2 bus, this LED flashes once.</td> </tr> <tr> <td>RX2</td> <td>Green</td> <td>When the ECAN-240-FD receives one CAN/CAN FD message from CAN2 bus, this LED flashes once.</td> </tr> </tbody> </table>	LED	Color	Description	Power	Red	When power on the ECAN-240-FD, this LED is turned on.	ST1	Red	If the ECAN-240-FD detects the CAN error-warning, error-passive and bus-off status on the CAN1 bus, this LED flashes once per 100 ms.	ST2	Red	If the ECAN-240-FD detects the CAN error-warning, error-passive and bus-off status on the CAN2 bus, this LED flashes once per 100 ms.	TX1	Green	When the ECAN-240-FD transmits one CAN/CAN FD message to CAN1 bus, this LED flashes once.	RX1	Green	When the ECAN-240-FD receives one CAN/CAN FD message from CAN1 bus, this LED flashes once.	TX2	Green	When the ECAN-240-FD transmits one CAN/CAN FD message to CAN2 bus, this LED flashes once.	RX2	Green	When the ECAN-240-FD receives one CAN/CAN FD message from CAN2 bus, this LED flashes once.
LED	Color	Description																							
Power	Red	When power on the ECAN-240-FD, this LED is turned on.																							
ST1	Red	If the ECAN-240-FD detects the CAN error-warning, error-passive and bus-off status on the CAN1 bus, this LED flashes once per 100 ms.																							
ST2	Red	If the ECAN-240-FD detects the CAN error-warning, error-passive and bus-off status on the CAN2 bus, this LED flashes once per 100 ms.																							
TX1	Green	When the ECAN-240-FD transmits one CAN/CAN FD message to CAN1 bus, this LED flashes once.																							
RX1	Green	When the ECAN-240-FD receives one CAN/CAN FD message from CAN1 bus, this LED flashes once.																							
TX2	Green	When the ECAN-240-FD transmits one CAN/CAN FD message to CAN2 bus, this LED flashes once.																							
RX2	Green	When the ECAN-240-FD receives one CAN/CAN FD message from CAN2 bus, this LED flashes once.																							

2. Ethernet RJ-45 Jack



The ECAN-240-FD module is equipped with an RJ-45 jack that is used as the 10/100 Base-TX Ethernet port and features networking capabilities. When an Ethernet link is detected and an Ethernet packet is received, the Link/Act LED (Green) indicator will be illuminated. When Ethernet running at 100 Mbps, the 10/100M LED (Orange) indicator will be illuminated.

3. 9-pin D-Sub male connector

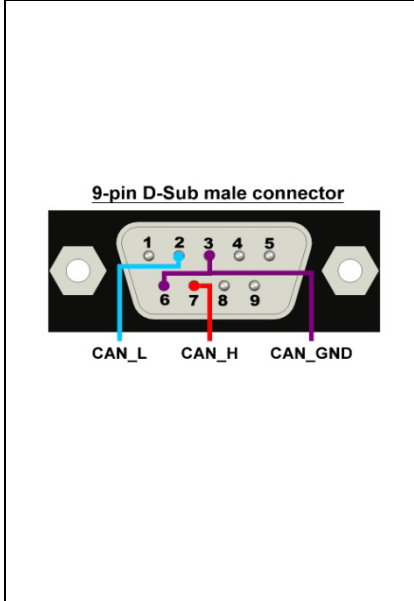

Pin assignments of CAN Bus Connector

Pin	Description
1	N/A
2	CAN Low
3	CAN Ground
4	N/A
5	N/A
6	CAN Ground
7	CAN High
8	N/A
9	N/A

4. CAN Bus Terminal Resistor

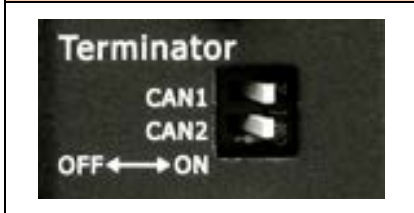

Enable/Disable 120Ω terminal resistor on CAN1/2 port.
 ON → Enable 120Ω terminal resistor
 OFF → Disable 120Ω terminal resistor

5. Rotary Switch (SW1/SW2)

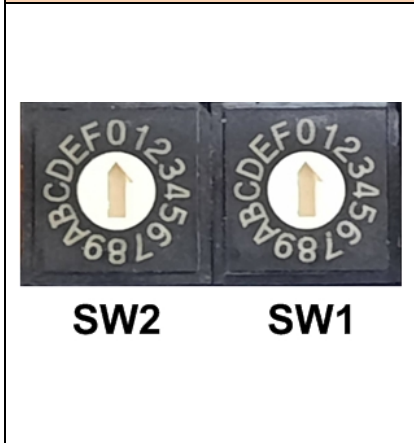

SW2	SW1	Description
F	F	When booting up, ECAN-240-FD will into firmware upgrade mode. If there is no update action after 5 seconds, the module will work with factory default setting.
F	E	When booting up, ECAN-240-FD will restore and work with factory default setting.
Others		User-defined

6.	+10 to +30 V_{DC} Terminal Block
 <p data-bbox="193 577 419 613">+Vs GND F.G.</p>	<p>The ECAN-240-FD is equipped with a +10 V_{DC} to +30 V_{DC} 3-pin terminal block that can be used to connect a DC power supply.</p>

2.3. Dimensions

The following diagrams provide the dimensions of the ECAN-240-FD module. All dimensions are in millimeters.

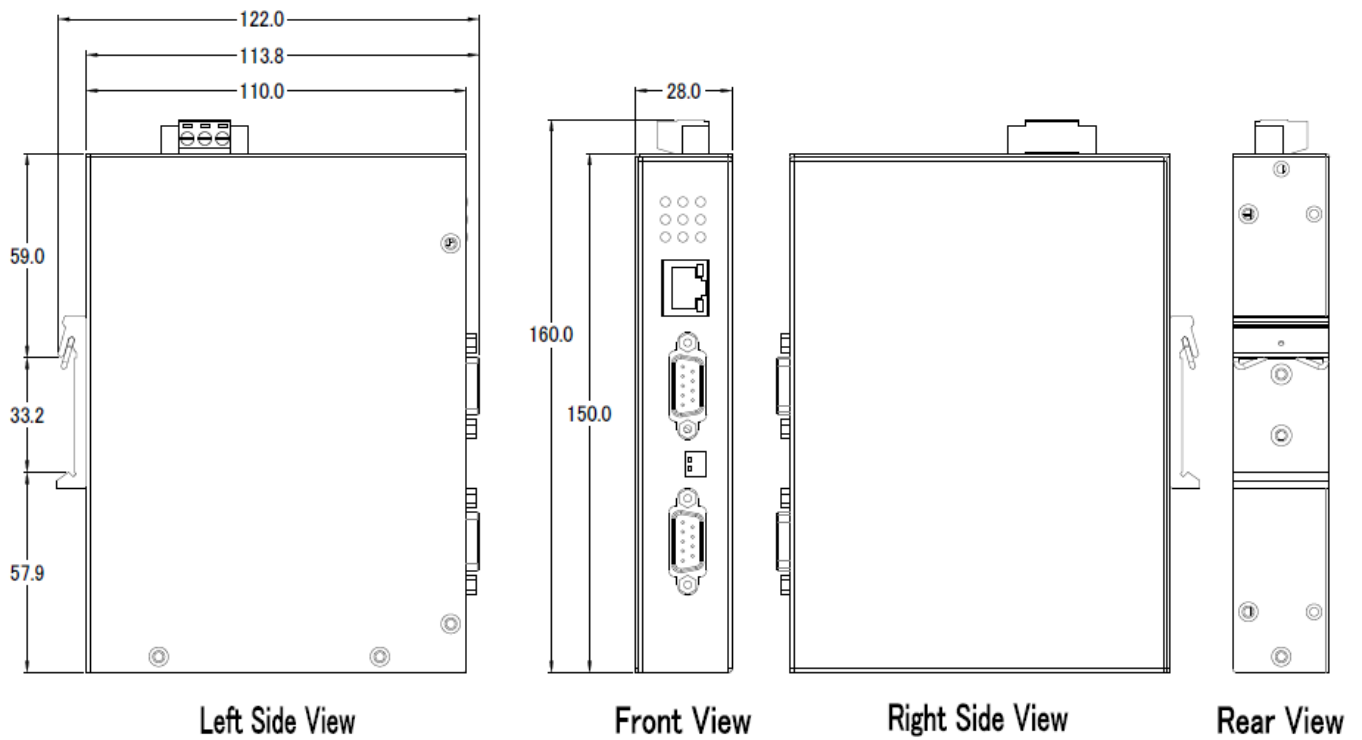

2.4. Terminal Resistor Notes for CAN Interface

In order to minimize the effects of reflection on the CAN Bus, the bus must be terminated using a terminal resistor at each end. According to the specifications given in ISO 11898-2, each terminal resistor should be 120Ω (or between 96Ω and 144Ω). The bus topology and the positions of these terminal resistors are shown below.

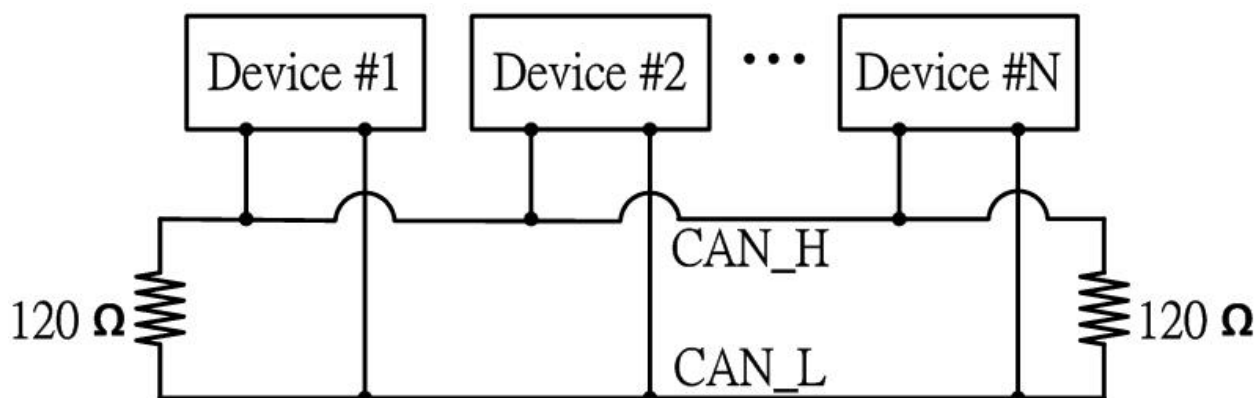

The ECAN-240-FD module includes two CAN ports and terminal resistors are provided for each CAN port. The terminal resistor can be enabled or disabled via the terminator DIP-switches as illustrated in following figure.



As indicated in the figure, when the DIP-switch is in the OFF position, the terminal resistor function is disabled. Similarly, when the DIP-switch is in the ON position, the terminal resistor function is enabled.

3. Getting Started for ECAN-240-FD

This chapter provides detailed information about how to use the ECAN-240-FD module. Before using the module, Ethernet configuration and eSearch utility installation procedures must first be fully completed. Follow the procedure described below:

3.1. Connecting the Power Supply and the Host PC

1. Ensure that the network settings on your PC are configured correctly.
2. Ensure that the Windows firewall or any Anti-Virus firewall software is correctly configured or temporarily disable these functions; otherwise the **“Search Servers”** function in the eSearch Utility may not work as required. You may need to contact your System Administrator for more details of how to do this.
3. Check that the SW1/SW2 switch is in the **“0/0”** position

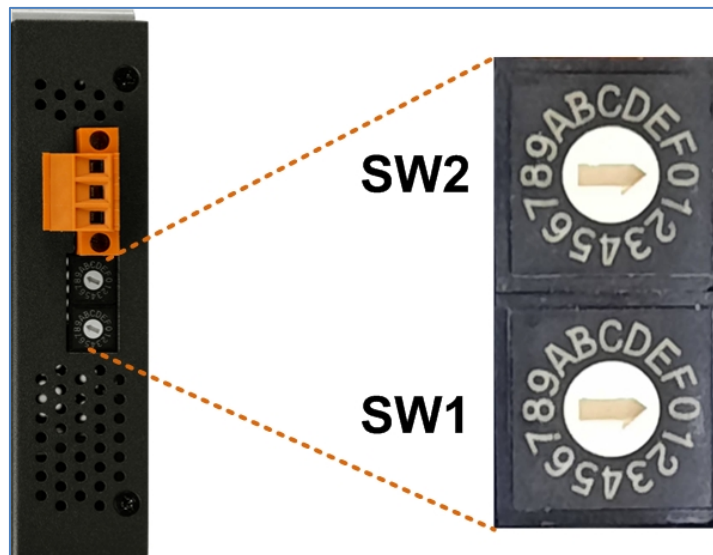

4. Connect both the ECAN-240-FD and the Host computer to the same sub-network or the same Ethernet Switch, and then power on the ECAN-240-FD. Refer to following figure for illustrations of how to do this.

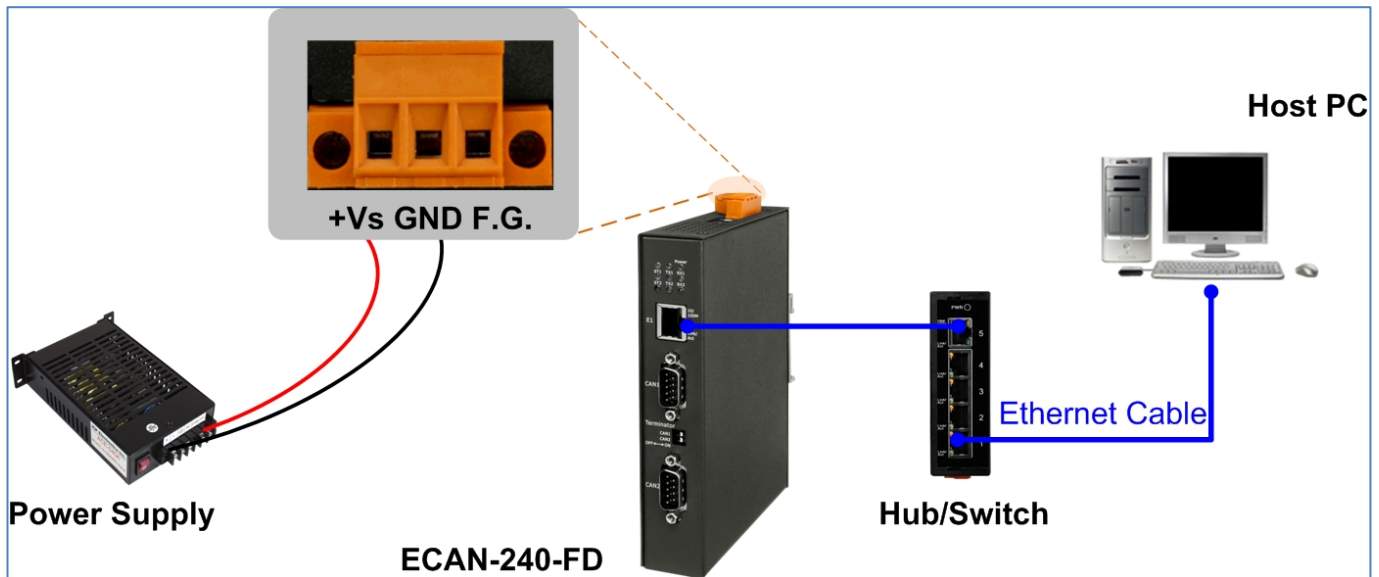

5. Verify that the Power LED indicator is illuminated.

3.2. Configuring the Network Settings

1. Downloaded the eSearch Utility and installed according to the installation instructions. The eSearch Utility can be obtained from the ICP DAS web site. The location of the install files on the download address is shown below:

<https://www.icpdas.com/tw/download/show.php?num=6710&nation=TW&kind1=&model=&kw=esearch>



Note: The version of the eSearch Utility must be v1.3.0 or higher.

2. Open the eSearch Utility and then click the **“Search Server”** button to search for the ECAN-240-FD module.
3. Once the search process is complete, double-click the name of the ECAN-240-FD module to open the **“Configure Server”** dialog box.

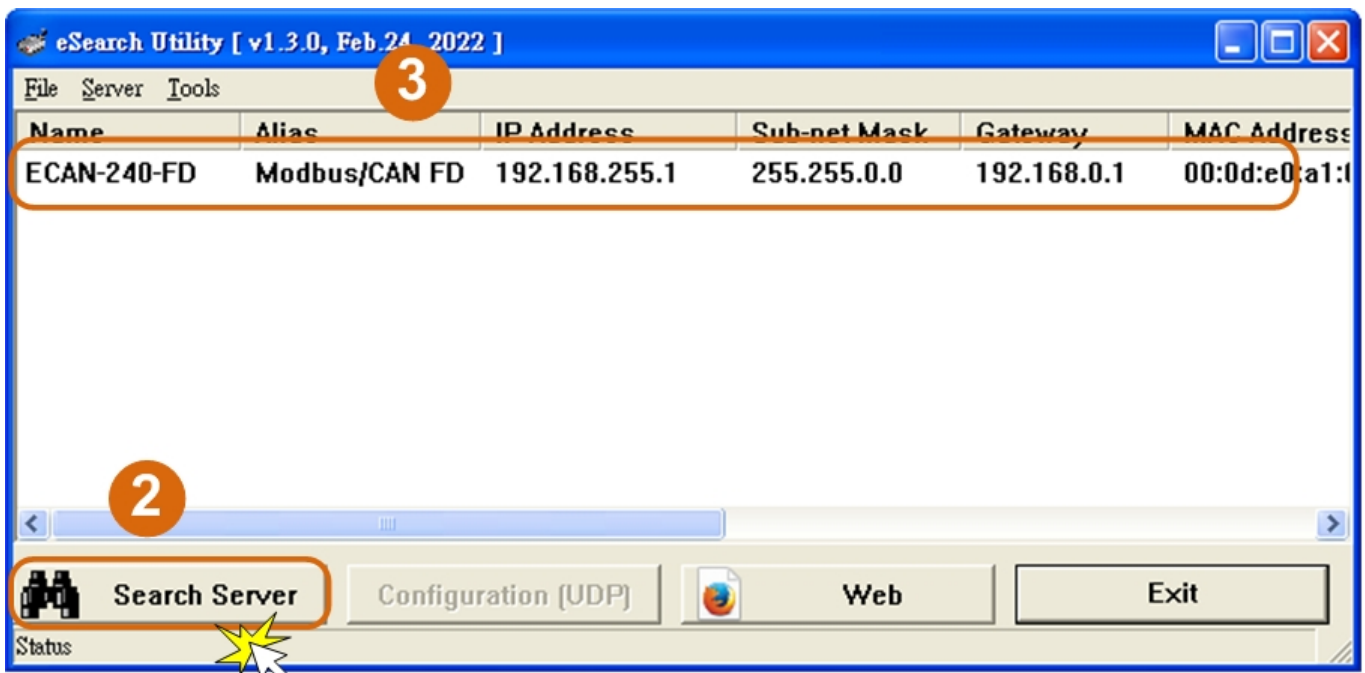

4. Enter the network settings information, including the IP, Mask and Gateway addresses, and then click **“OK”** button. The new settings for the ECAN-240-FD will take effect within 2 seconds. If you don't know the correct network configuration information, contact your Network Administrator to obtain the details.

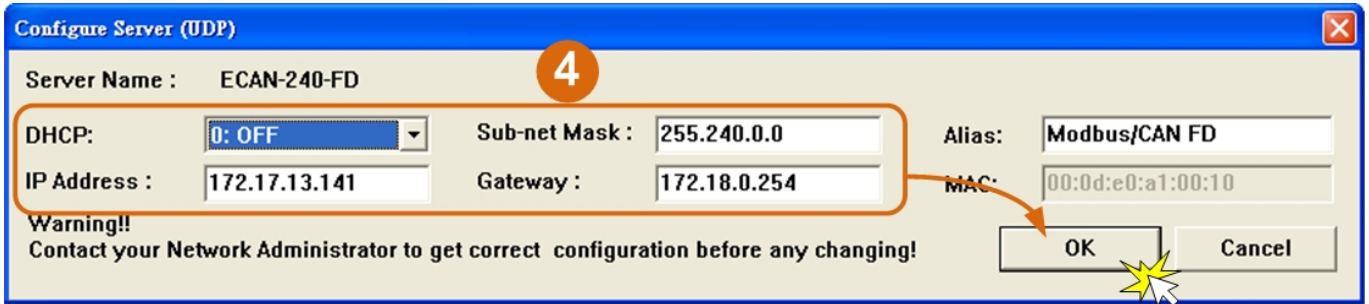

- Wait 2 seconds and click **“Search Server”** button again to ensure the ECAN-240-FD is working well with new configuration.

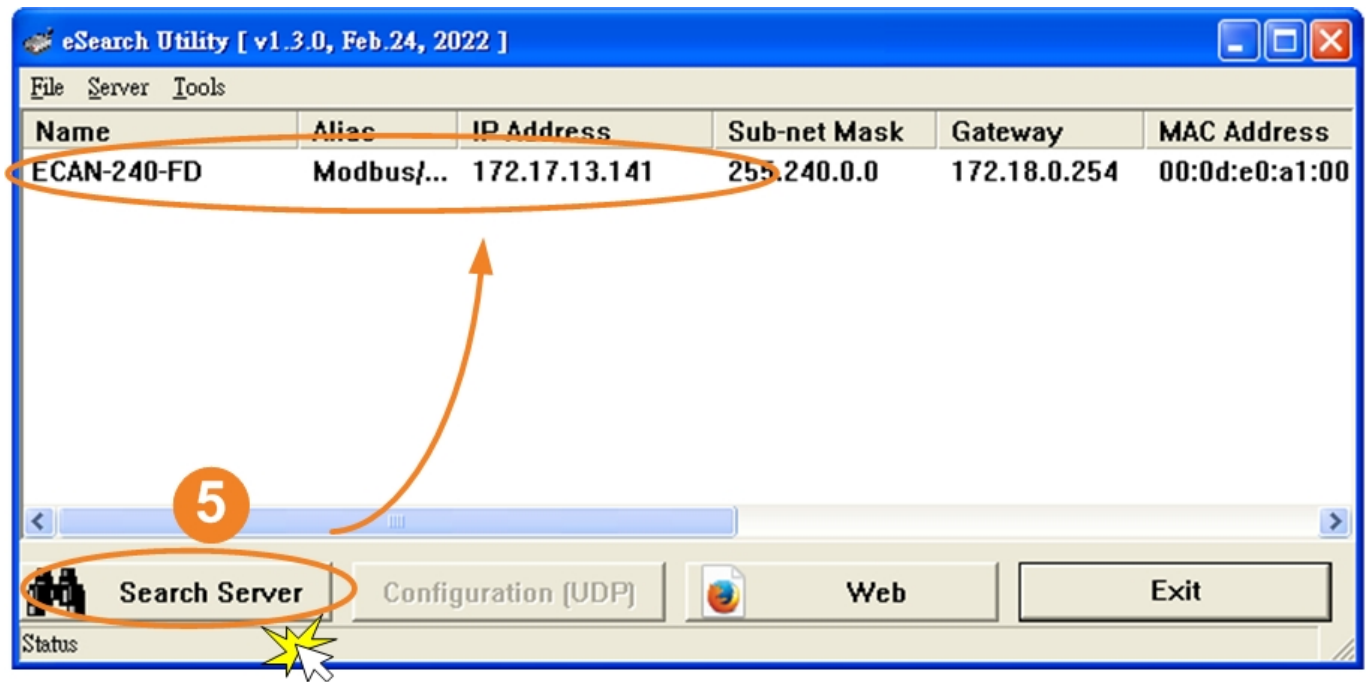

Factory Default Settings of ECAN-240-FD Module:

IP Address	192.168.255.1
Subnet Mask	255.255.0.0
Gateway	192.168.0.1

3.3. Configuring the CAN Port

1. Open a web browser, such as Google Chrome, Internet Explorer, or Firefox, and enter the URL for the ECAN-240-FD module in the address bar of the browser, or click the “**Web**” button in the eSearch Utility. You can right click the IP address field and click the “Copy to Clipboard” to copy the IP address.
2. When the login screen is displayed, enter the password (use the default password: **admin**) in the login password field, and then click the “**Submit**” button to enter the configuration web page.

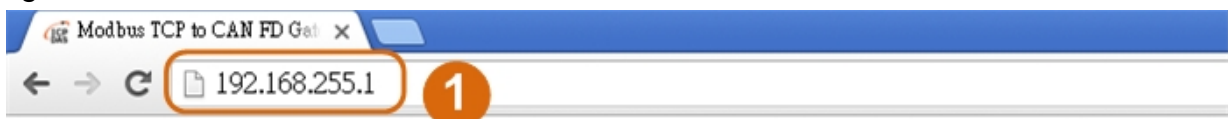

The system is logged out.

To enter the web configuration page, please type password in the following field.



Note: For the first time to use the ECAN-240-FD device, you may need to change the default password to other value.

3. Click the “Port1” tab to display the Port1 Settings page.



Model Name:	ECAN-240-FD	Alias Name:	CAN FD Gateway
Firmware Version:	V2.00 [2023/07/17]	MAC Address:	00-0D-E0-20-00-10
IP Address:	192.168.255.1	Communication Mode:	Modbus TCP Server
Initial Switch:	00	Local Command Port:	502

- Select the appropriate CAN Port and Filter Settings from the relevant drop down options. Click **“Update Settings”** to save your settings.

CAN Port 1 Settings

CAN Port Settings	Current	Updated	Comment
CAN FD Specification:	ISO	ISO ▾	ISO/Non-ISO sp
Arbitration Bit Rate (kbps):	1000.000	1000.000	e.g.: 1000.000,
Data Phase Bit Rate (kbps):	1000.000	1000.000	e.g.: 1000.000,
Arbitration Sample Point (%):	87.50	87.50	e.g.: 87.50, 1.00
Data Phase Sample Point (%):	87.50	87.50	e.g.: 87.50, 1.00
CAN Filter Settings	Current	Updated	Comment
Reject Remote Standard Frames:	Disable	Disable ▾	Disable/Enable
Reject Remote Extended Frames:	Disable	Disable ▾	Disable/Enable
Standard ID Filter (Hex):	0x000	000	11-bit ID filter, 0
Standard ID Mask (Hex):	0x000	000	11-bit ID mask, 0
Extended ID Filter (Hex):	0x00000000	00000000	29-bit ID filter, 0
Extended ID Mask (Hex):	0x00000000	00000000	29-bit ID mask, 0

4 

Update Settings

3.4. Self-Test

Writing a CAN message to CAN1 and reading a CAN message from CAN2 via Modbus Poll Tool.

1. Connect the CAN1 “CAN_H/CAN_L” pins with CAN2 port.

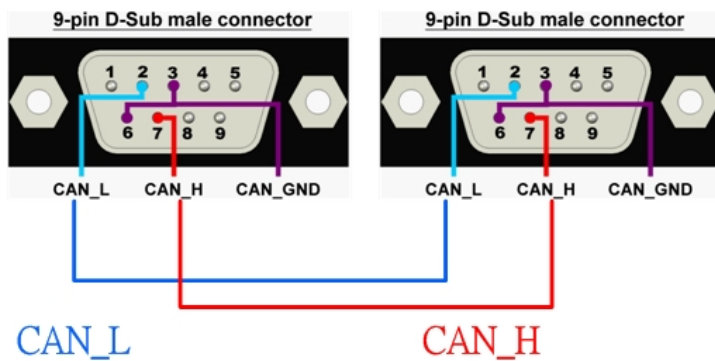

2. Download and install the “Modbus Poll” test program at below link.

<https://www.modbustools.com/download.html>

3. Double-click the Modbus Poll shortcut to open.



4. Select the “Read/Write Definition...” item from the “Setup” menu to open the “Read/Write Definition” dialog box.
5. Configure the setting for writing a CAN/CAN FD message to “CAN1 Tx FIFO #1” address (00000).
6. Configure the setting for reading a CAN/CAN FD message from “CAN2 Rx FIFO #1” address (04096).

Note: Refer to section 6 for Modbus address definition of ECAN-240-FD.

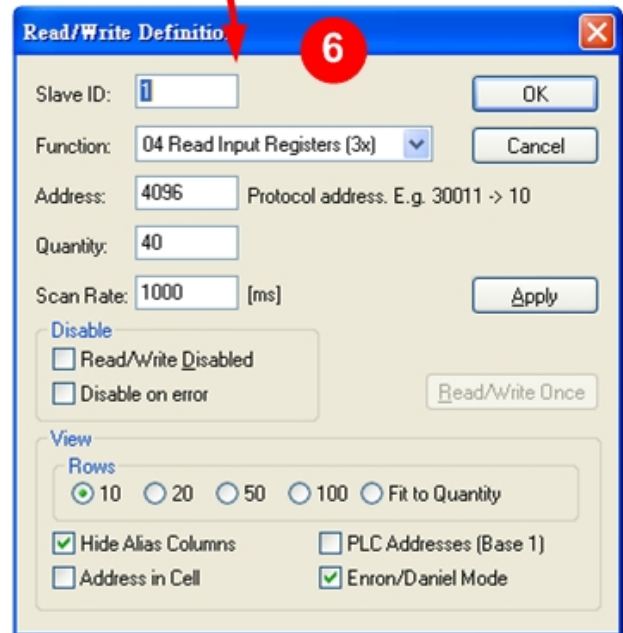
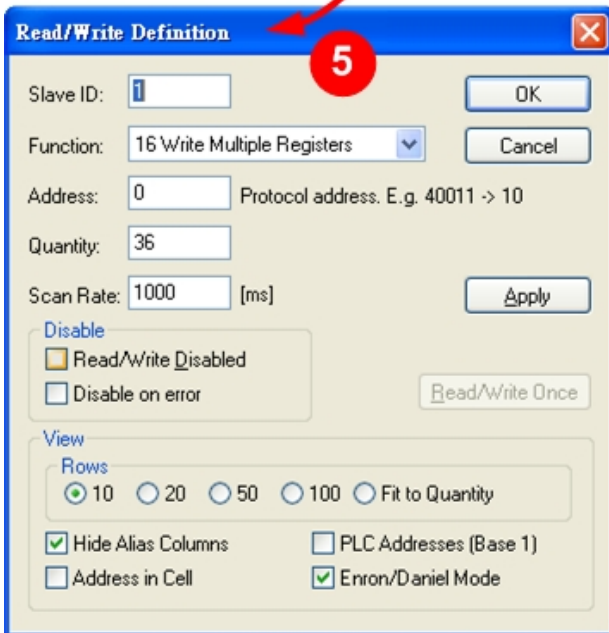
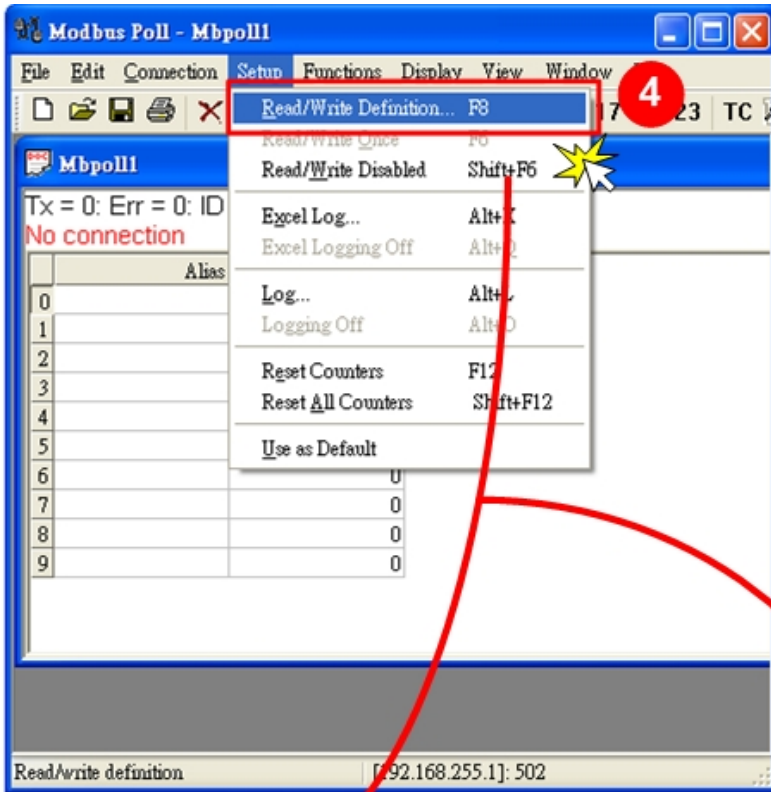

7. Select the “Connect...”item from the “Connection” menu to open the “Connection Setup” dialog box.
8. Configure the Ipv4 address and TCP port (default: 502) of ECAN-240-FD click “OK” to connect the ECAN-240-FD for testing.

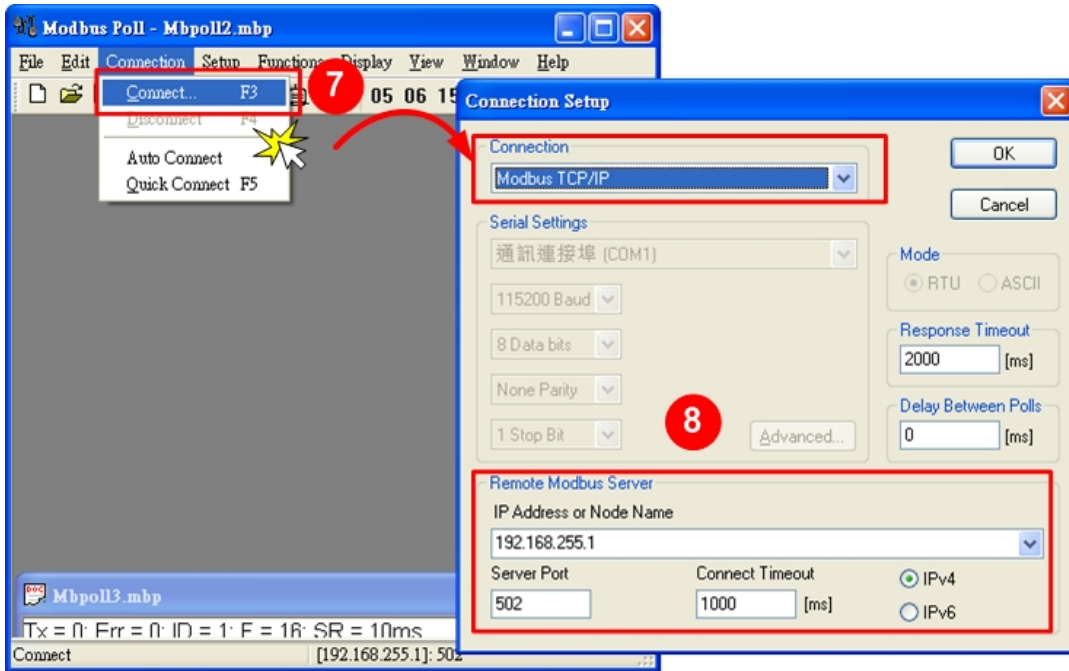

9. Write a CAN/CAN FD message to “CAN1 Tx FIFO #1” address (0000)
10. Read a CAN/CAN FD message from “CAN2 Rx FIFO #1” address (04096).

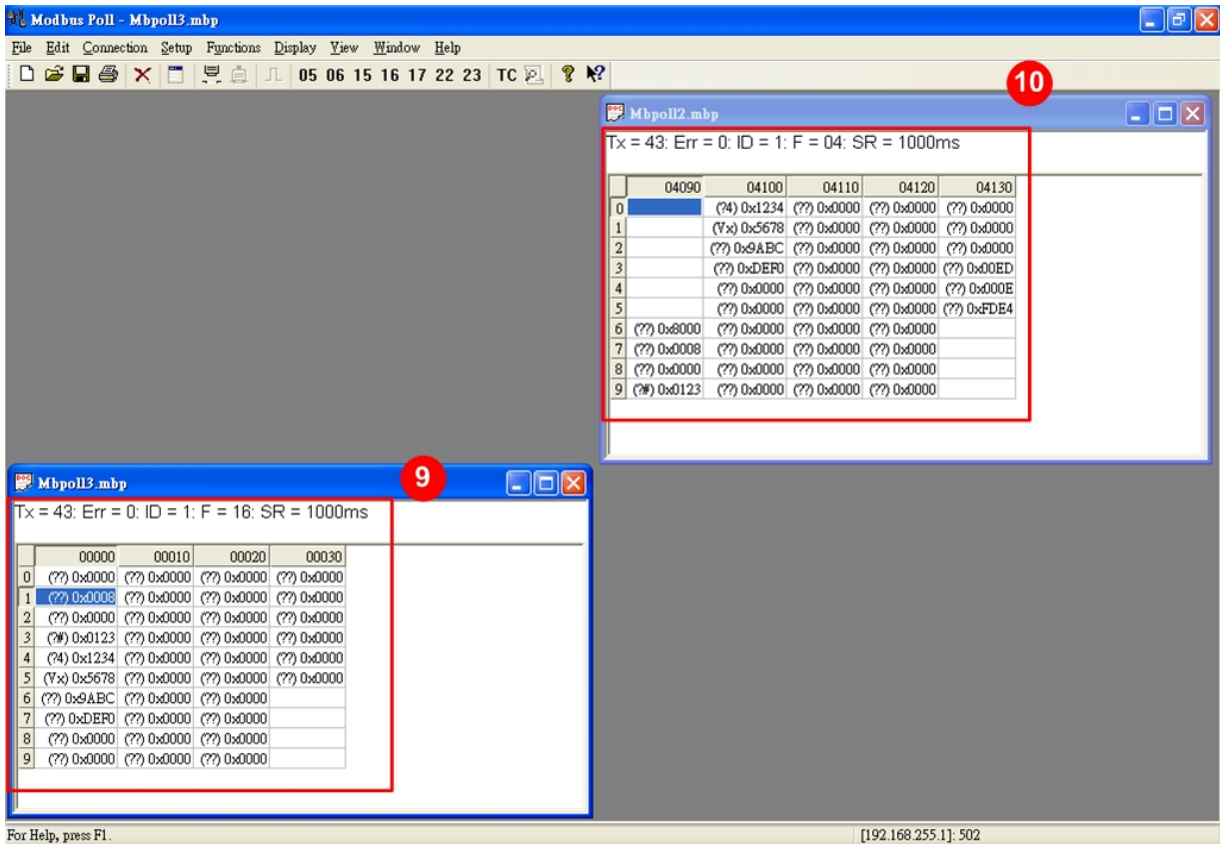

11. If there is no “Err” count in the request/response messages, the test was successful.

4. Web Configuration

Once the ECAN-240-FD module has been correctly configured and is functioning on the network normally, the configuration details can be retrieved or modified using either the eSearch Utility or a standard web browser.

4.1. Logging in to the ECAN-240-FD Web Server

The embedded ECAN-240-FD web server can be accessed from any computer that has an Internet connection.

Step 1: Open a new browser window.

Open a web browser, for example, Google Chrome, Firefox or Internet Explorer, which are reliable and popular Internet browsers that can be used to configure ECAN-240-FD module.



Note that if you intend to use Internet Explorer, ensure that the cache function is disabled in order to prevent browser access errors.

Step 2: Enter the URL for the ECAN-240-FD web server

Ensure that you have correctly configured the network settings for the ECAN-240-FD module (refer to [Chapter 3 Setting up the ECAN-240-FD module](#) for detailed instructions), and then enter the URL for the ECAN-240-FD web server in the address bar of the browser.



Step 3: Enter the Password

After the main login page is displayed, enter a password (the factory default password is “admin”), and then click the “Submit” button to continue.

Note: For the first time to use the ECAN-240-FD device, you may need to change the default password to other value.

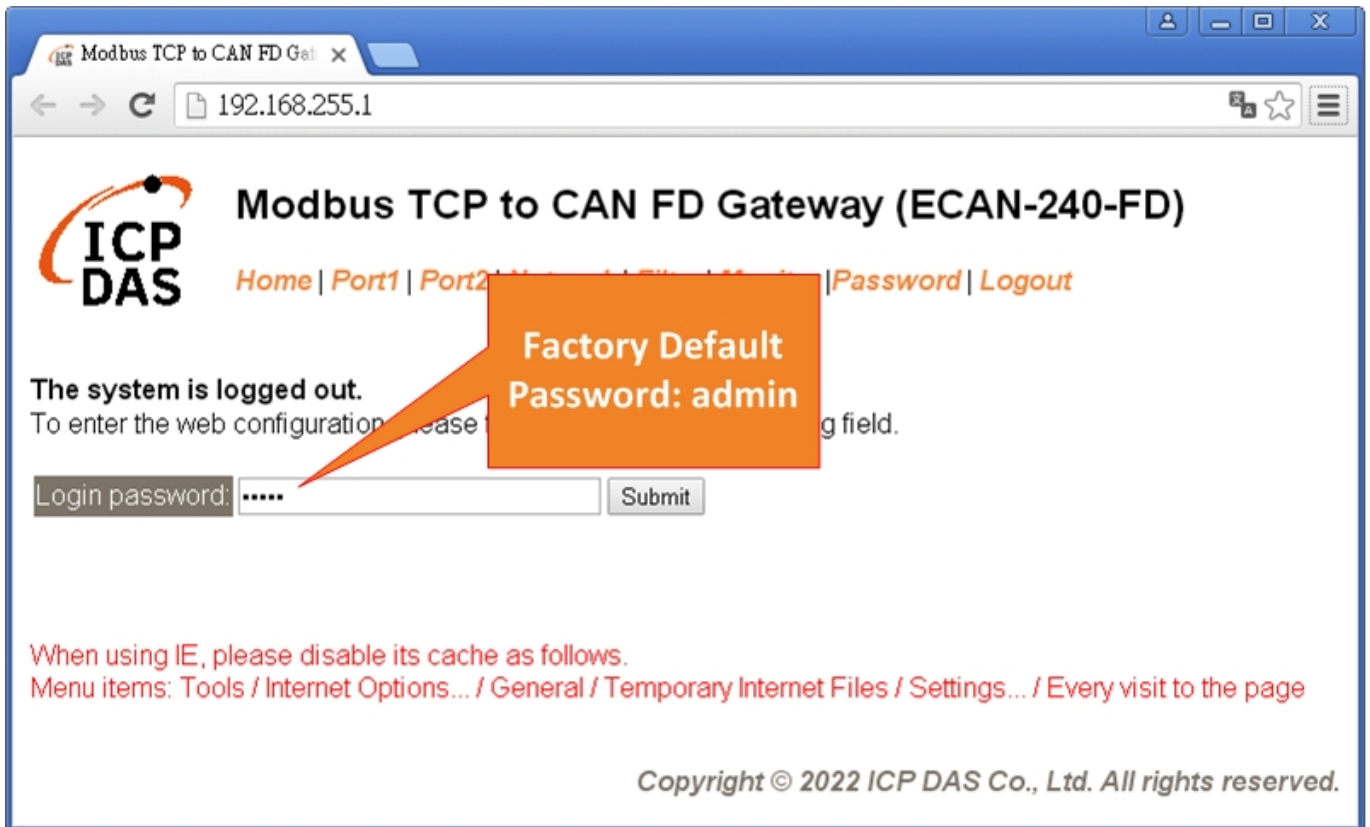

Step 4: Log in to the ECAN-240-FD Web Server

After logging into the ECAN-240-FD web server, the main page will be displayed.

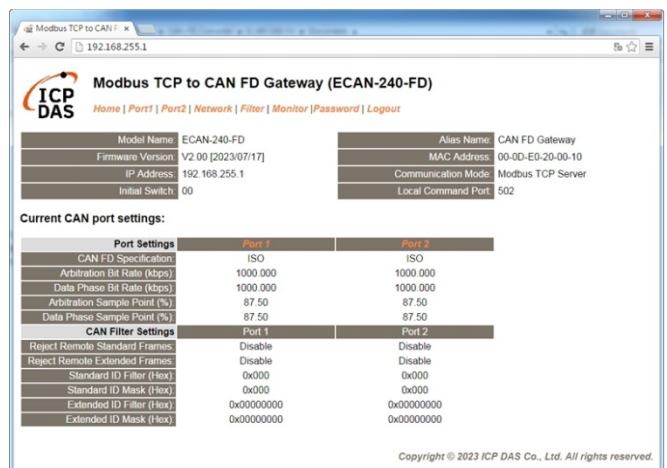

4.2. Home Page

The Home link connects to the main page, which contains two parts.



The first part of this page provides basic information about the ECAN-240-FD hardware and software

Model Name:	ECAN-240-FD	Alias Name:	CAN FD Gateway
Firmware Version:	V2.00 [2023/07/17]	MAC Address:	00-0D-E0-20-00-10
IP Address:	192.168.255.1	Communication Mode:	Modbus TCP Server
Initial Switch:	00	Local Command Port:	502

The software and hardware information section includes information related to the Model Name, the current Firmware version, the IP Address, the current position of the Initial Switch, the Alias, the MAC Address, and the Communication Mode, and the Local Command Port values. **If you update the firmware for the ECAN-240-FD module, this page can be used to check the version information** of the ECAN-240-FD software.

The second part of this page provides the status of the port settings.

Current CAN port settings:

Port Settings	Port 1	Port 2
CAN FD Specification:	ISO	ISO
Arbitration Bit Rate (kbps):	1000.000	1000.000
Data Phase Bit Rate (kbps):	1000.000	1000.000
Arbitration Sample Point (%):	87.50	87.50
Data Phase Sample Point (%):	87.50	87.50
CAN Filter Settings	Port 1	Port 2
Reject Remote Standard Frames:	Disable	Disable
Reject Remote Extended Frames:	Disable	Disable
Standard ID Filter (Hex):	0x000	0x000
Standard ID Mask (Hex):	0x000	0x000
Extended ID Filter (Hex):	0x00000000	0x00000000
Extended ID Mask (Hex):	0x00000000	0x00000000

4.3. CAN Port Page



Modbus TCP to CAN FD Gateway (ECAN-240-FD)

Home | **Port1** | **Port2** | Network | Filter | Monitor | Password | Logout

Model Name:	ECAN-240-FD	Alias Name:	CAN FD Gateway
Firmware Version:	V2.00 [2023/07/17]	MAC Address:	00-0D-E0-20-00-10
IP Address:	192.168.255.1	Communication Mode:	Modbus TCP Server
Initial Switch:	00	Local Command Port:	502

4.3.1. Port1/2 Settings

The Port1/2 Settings section provides functions allowing items such as CAN port and filter settings to be configured.

CAN Port 1 Settings

CAN Port Settings	Current	Updated	Comment
CAN FD Specification:	ISO	ISO ▾	ISO/Non-ISO specification
Arbitration Bit Rate (kbps):	1000.000	<input type="text" value="1000.000"/>	e.g.: 1000.000, 10.000 ~ 1000.000 kbps
Data Phase Bit Rate (kbps):	1000.000	<input type="text" value="1000.000"/>	e.g.: 1000.000, 100.000 ~ 10000.000 kbps
Arbitration Sample Point (%):	87.50	<input type="text" value="87.50"/>	e.g.: 87.50, 1.00 ~ 99.00 %
Data Phase Sample Point (%):	87.50	<input type="text" value="87.50"/>	e.g.: 87.50, 1.00 ~ 99.00 %
CAN Filter Settings	Current	Updated	Comment
Reject Remote Standard Frames:	Disable	Disable ▾	Disable/Enable reject function
Reject Remote Extended Frames:	Disable	Disable ▾	Disable/Enable reject function
Standard ID Filter (Hex):	0x000	<input type="text" value="000"/>	11-bit ID filter, 0x000 ~ 0x7FF
Standard ID Mask (Hex):	0x000	<input type="text" value="000"/>	11-bit ID mask, 0x000 ~ 0x7FF
Extended ID Filter (Hex):	0x00000000	<input type="text" value="00000000"/>	29-bit ID filter, 0x00000000 ~ 0x1FFFFFFF
Extended ID Mask (Hex):	0x00000000	<input type="text" value="00000000"/>	29-bit ID mask, 0x00000000 ~ 0x1FFFFFFF
<input type="button" value="Update Settings"/>			

The following is an overview of the parameters contained in the Port1/2 Settings section:

Item	Description	Default
CAN Port Settings		
CAN FD Specification	CAN FD specification: ISO or Non-ISO specification	ISO
Arbitration Bit Rate (kbps)	CAN/CAN FD arbitration bit rate, valid range: 10.000 ~ 1000.000 kbps	1000.000
Data Phase Bit Rate (kbps)	CAN FD data phase bit rate, valid range: 100.000 ~ 10000.000 kbps	1000.000
Arbitration Sample Point (%)	CAN/CAN FD arbitration bit timing sample point, valid range: 1.00 ~ 99.00 %.	87.50
Data Phase Sample Point (%)	CAN FD data phase bit timing sample point, valid range: 1.00 ~ 99.00 %.	87.50
CAN Filter Settings		
Reject Remote Standard Frames	Reject remote standard CAN/CAN FD frame Disable: disable this reject function Enable: enable this reject function	Disable
Reject Remote Extended Frames	Reject remote extended CAN/CAN FD frame Disable: disable this reject function Enable: enable this reject function	Disable
Standard ID Filter (Hex)	Filter ID setting of standard CAN frame, valid range: 000 ~ 7FF. A filter that accepts frame whose identifier verifies: identifier & "standard Mask ID" == "standard Filter ID" & "standard Mask ID"	000
Standard ID Mask (Hex)	Mask ID setting of standard CAN frame, valid range: 000 ~ 7FF. A filter that accepts frame whose identifier verifies: identifier & "standard Mask ID" == "standard Filter ID" & "standard Mask ID"	000
Extended ID Filter (Hex)	Filter ID setting of extended CAN frame, valid range: 00000000 ~ 1FFFFFFF. A filter that accepts frame whose identifier verifies: identifier & "extended Mask ID" == "extended Filter ID" & "extended Mask ID"	00000000
Extended ID Mask	Mask ID setting of extended CAN frame, valid range: 00000000	00000000

(Hex)	~ 1FFFFFFF. A filter that accepts frame whose identifier verifies: identifier & "extended Mask ID" == "extended Filter ID" & "extended Mask ID"	
Update Settings	Click this button to save the revised settings to the ECAN-240-FD. All settings will take effect after rebooting the device.	

4.3.2. Specific CAN ID Settings

This section provides functions allowing items such as specific CAN ID settings, which CAN frame will be saved into the Modbus address of “CAN Rx buffer”, to be configured. This function is applicable when the module is set to Modbus TCP Server mode.

Port1 Specific CAN ID Settings

Specific CAN ID List	Current	Updated	Comment
Spec. CAN ID Mode	Disable	Disable ▾	Disable/Enable Specific CAN ID function
		Enable	
Specific CAN ID List	Current	Updated	Comment
Spec. CAN ID Mode	Disable	Enable ▾	Disable/Enable Specific CAN ID function
ID #00	N/A	N/A ▾ 0	#00, N/A:no used ; STD:2.0A ; EXT:2.0B
ID #01	N/A	N/A ▾ 0	#01
ID #02	N/A	N/A ▾ 0	#02
ID #03	N/A	N/A ▾ 0	#03
ID #04	N/A	N/A ▾ 0	#04
ID #05	N/A	N/A ▾ 0	#05
ID #06	N/A	N/A ▾ 0	#06
ID #07	N/A	N/A ▾ 0	#07
ID #21	N/A	N/A ▾ 0	#21
ID #22	N/A	N/A ▾ 0	#22
ID #23	N/A	N/A ▾ 0	#23
ID #24	N/A	N/A ▾ 0	#24
ID #25	N/A	N/A ▾ 0	#25
ID #26	N/A	N/A ▾ 0	#26
ID #27	N/A	N/A ▾ 0	#27
ID #28	N/A	N/A ▾ 0	#28
ID #29	N/A	N/A ▾ 0	#29
Update Settings			

Item	Description	Default
Specific CAN ID List		
Spec. CAN ID Mode	Disable/Enable the Specific CAN ID function of this port	Disable
ID #00 ~ ID #29	<p>Specific CAN ID #00 ~ #29 settings (hexadecimal format). When received CAN frame's ID matched these “Specific CAN ID #00 ~ #29” settings, this frame will be save into related Modbus addresses of “CAN Rx Buffer Message #00 ~ #29”. Refer to Section 6.1.1.4 CAN Rx Buffer and Section 6.2.1.4 CAN FD Rx Buffer for more details.</p> <p>N/A: this field no used. STD: using standard (2.0A) CAN ID, valid range: 000 ~ 7FF. EXT: using extended (2.0B) CAN ID, valid range: 00000000 ~ 1FFFFFFF.</p>	N/A, 0
Update Settings	Click this button to save the revised settings to the ECAN-240-FD. All settings will take effect after rebooting the device.	

4.4. Network Page



Modbus TCP to CAN FD Gateway (ECAN-240-FD)

Home | Port1 | Port2 | **Network** | Filter | Monitor | Password | Logout

Model Name:	ECAN-240-FD	Alias Name:	CAN FD Gateway
Firmware Version:	V2.00 [2023/07/17]	MAC Address:	00-0D-E0-20-00-10
IP Address:	192.168.255.1	Communication Mode:	Modbus TCP Server
Initial Switch:	00	Local Command Port:	502

4.4.1. IP Address Settings

The **Address Type**, **Static IP Address**, **Subnet Mask** and **Default Gateway** values are the most important network settings and should always correspond to the LAN configuration. If they do not match, the ECAN-240-FD module will not operate correctly. If the settings are changed while the module is operating, any connection currently in use will be lost and an error will occur.

IP Address Settings

IP Address	
Address Type:	Static IP ▾
Static IP Address:	192 . 168 . 255 . 1
Subnet Mask:	255 . 255 . 0 . 0
Default Gateway:	192 . 168 . 0 . 1
User-defined MAC Address:	FF-FF-FF-FF-FF-FF (Format: FF-FF-FF-FF-FF-FF)
<input type="button" value="Update Settings"/>	

The following is an overview of the parameters contained in the IP Address Settings section:

Item	Description
IP Address	
Address Type	Static IP: If no DHCP server is installed on the network, the network settings can be configured manually. Refer to Manual Configuration for more details.
	DHCP: The Dynamic Host Configuration Protocol (DHCP) is a network application protocol that automatically assigns an IP address to each device. Refer to Dynamic Configuration for more details.
Static IP Address	Each ECAN-240-FD connected to the network must have its own unique IP address. This parameter is used to assign a specific IP address.
Subnet Mask	This parameter is used to assign the subnet mask for the ECAN-240-FD device. The subnet mask indicates which portion of the IP address is used to identify the local network or subnet.
Default Gateway	This parameter is used to assign the subnet mask for the ECAN-240-FD device. The subnet mask indicates which portion of the IP address is used to identify the local network or subnet.
User-defined MAC Address	This parameter is used to set a user-defined MAC address, which must be in the format FF-FF-FF-FF-FF-FF.
Update Settings	Click this button to save the revised settings to the ECAN-240-FD. All settings will take effect after rebooting the device.

Manual Configuration

When using manual configuration, the network settings should be assigned in the following manner:

Step 1: Select the “Static IP” option from the “Address Type” drop-down menu.

Step 2: Enter the relevant details in the respective network settings fields.

Step 3: Click the “Update Settings” button to complete the configuration.

IP Address Settings

IP Address	
Address Type:	Static IP 1
Static IP Address:	192 . 168 . 255 . 1 2
Subnet Mask:	255 . 255 . 0 . 0
Default Gateway:	192 . 168 . 0 . 1
User-defined MAC Address:	FF-FF-FF-FF-FF-FF (Format: FF-FF-FF-FF-FF-FF)
Update Settings 3	

Dynamic Configuration

Dynamic configuration is very easy to perform. If a DHCP server is connected to you network, a network address can be dynamically configured by using the following procedure:

Step 1: Select the “DHCP” option from the “Address Type” drop-down menu.

Step 2: Click the “Update Settings” button to complete the configuration.

IP Address Settings

IP Address	
Address Type:	DHCP 1
Static IP Address:	192 . 168 . 255 . 1
Subnet Mask:	255 . 255 . 0 . 0
Default Gateway:	192 . 168 . 0 . 1
User-defined MAC Address:	FF-FF-FF-FF-FF-FF (Format: FF-FF-FF-FF-FF-FF)
Update Settings 2	

4.4.2. General Settings

The General Settings provides functions allowing items such as the Operation Settings, Network and Misc. setting to be configured.

General Settings

Operation Settings	
Operation Mode:	CAN FD ▾ (CAN, CAN FD Mode)
Communication Mode:	Modbus TCP Server ▾ (Modbus TCP Server, TCP/UDP Transparent)
Modbus Net ID:	1 (Default: 1)
Local Command Port:	502 (Default: 502)
Command Port Timeout: (Socket Watchdog)	180 (1 ~ 65535 seconds, 180=default, 0=disable)
Network	
HTTP port:	80 (Default: 80)
System Idle:	300 (30 ~ 65535 seconds, 300=default, 0=disable)
Web Auto-logout:	10 (1 ~ 255 minutes, 10=default, 0=disable)
CGI Configuration:	Enable ▾ (Enable/Disable the assign.cgi, Enable=default.)
UDP Configuration:	Enable ▾ (Enable/Disable the UDP Configuration, Enable=default.)
Misc.	
Alias Name:	CAN FD Gateway (Max. 18 characters)
Update Settings	

Operation settings will be different depending on the communication mode.

Modbus TCP Server Mode

Communication Mode:	Modbus TCP Server ▾ (Modbus TCP Server, TCP/UDP Transparent)
Modbus Net ID:	1 (Default: 1)
Local Command Port:	502 (Default: 502)

TCP Transparent Mode

Communication Mode:	TCP Transparent ▾ (Modbus TCP Server, TCP/UDP Transparent)
Transmission Interval:	10 (1 ~ 65535 milliseconds, 10=default, 0=no wait)
Local Command Port:	502 (Default: 502)

UDP Transparent Mode

Communication Mode:	UDP Transparent ▾ (Modbus TCP Server, TCP/UDP Transparent)
Remote Device IP:	192 . 168 . 255 . 10
Remote Device Port:	10003 (Default: 10003)
Transmission Interval:	10 (1 ~ 65535 milliseconds, 10=default, 0=no wait)
Local Command Port:	502 (Default: 502)

The following is an overview of the parameters contained in the General Settings section:

Item	Description	Default
Operation Settings		
Operation Mode	CAN or CAN FD operation mode The Modbus and Ethernet commands used by the module vary depending on the operation mode.	CAN FD
Communication Mode	Modbus TCP Server User can get/set CAN messages via Modbus TCP method. This device will act as a Modbus TCP server. The client can make TCP connection with it and using Modbus TCP command to get/set CAN messages from/to the CAN ports.	Modbus TCP Server
	TCP Transparent User can get/set CAN messages via TCP method. This device will act as a TCP server. The client can make TCP connection the “Local command Port”. And messages came from CAN ports will be sent to the connected client.	
	UDP Transparent User can get/set CAN messages via UDP method. This device will act as a UDP server. The client can make UDP connection to the “Local command Port”. And messages came from the CAN ports will be sent to the UDP client device with “Remote Device IP” and “Remote UDP Port ” settings	
Modbus Net ID	For Modbus TCP Server Mode. This parameter is used to configure the Modbus Net ID. of this module	1
Remote Device IP	For UDP Transparent Mode. The IP setting of the remote device.	192.168. 255.10
Remote Device Port	For UDP Transparent Mode. The port setting of the remote device.	10003
Transmission Interval	For TCP and UDP Transparent Mode. Interval for polling the CAN port and sending data to Ethernet Settings range value: 1 ~ 65535 (millisecond)	10
Local Command	This parameter is used to configure the device local command	502

Port	port to a custom value depending on your requirement.	
Command Port Timeout (Socket Watchdog)	If the local command port does not receive any data for a certain period, the ECAN-240-FD can disconnect the socket. Settings range value: 1 ~ 65535 (seconds); Disabled: 0;	180
Network		
HTTP Port	The HTTP port number of the Web server function.	80
System Idle (Network Watchdog)	This parameter is used to configure the system timeout value. If there is no activity on the network for a specific period of time, the system will be rebooted based on the configured system timeout value. Timeout value range: 30 to 65535 (seconds); Disable = 0.	300
Web Auto-logout	This parameter is used to configure the automatic logout value. If there is no activity on the web server for a certain period of time, the current user account will be automatically logged out. Range: 1 to 65535 (minutes); Disable = 0.	10
CGI Configuration	This parameter is used to enable or disable CGI configuration function. For detailed CGI command and configuration information, refer to Section 5 "CGI Configuration" for more details.	Enable
UDP Configuration	This parameter is used to enable or disable UDP configuration function of eSearch tool.	Enable
Misc.		
Alias Name	This parameter is used to assign an alias for each ECAN-240-FD device to assist with easy identification.	CAN FD Gateway
Update Settings	Click this button to save the revised settings to the ECAN-240-FD device. All settings will take effect after rebooting the device.	

4.4.3. Restore Factory Defaults

Use the following procedure to reset all parameters to their original factory default settings:

Step 1: Click the “Restore Defaults” button to reset the configuration.

Step 2: Click the “OK” button in the message dialog box.

Step 3: Reboot the device and check whether the module has been reset to the original factory default settings for use with the eSearch Utility. Refer to [Chapter 3 Getting started for ECAN-240-FD](#) for more details.

Restore Factory Defaults

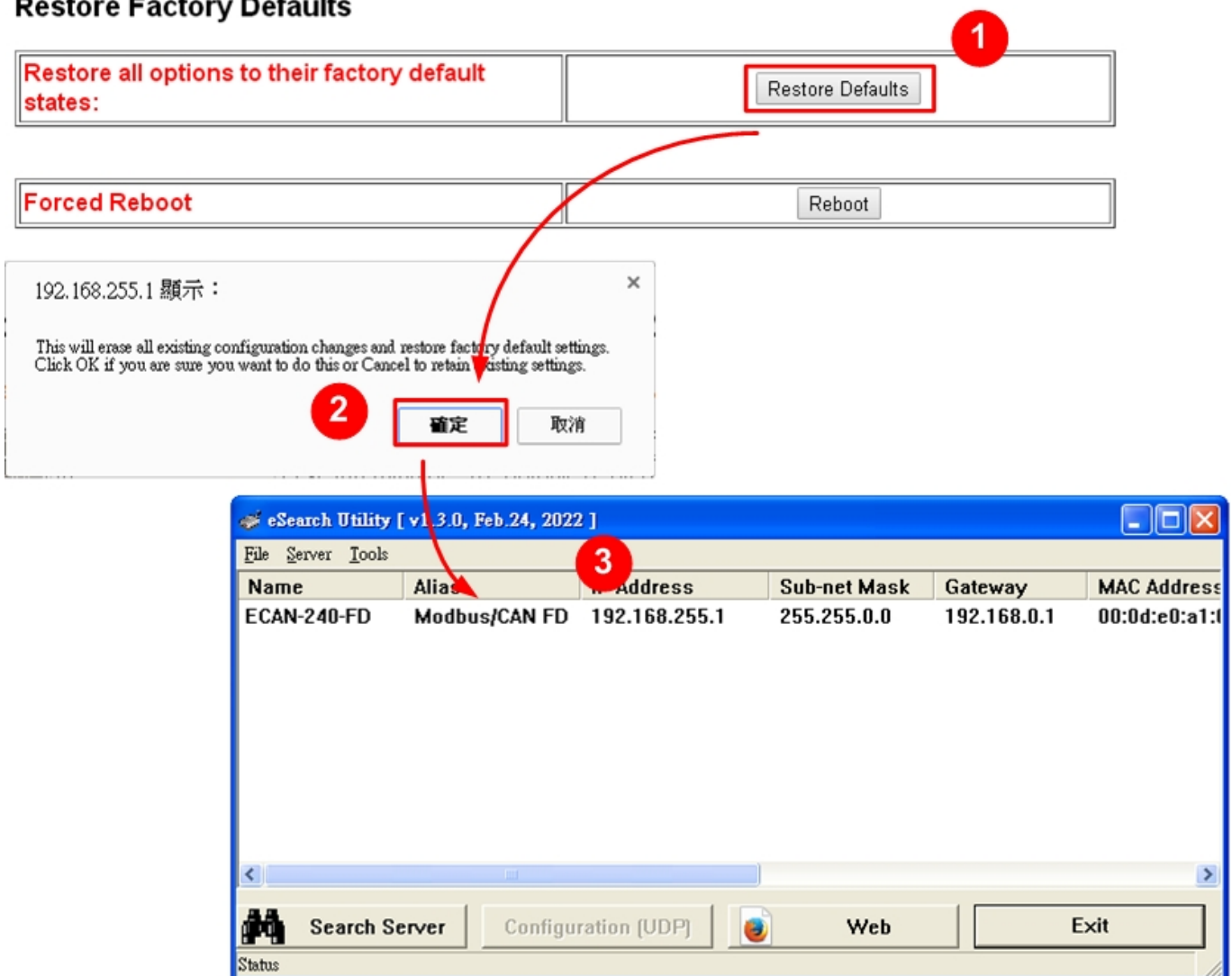

The following is an overview of the factory default settings:

Factory Default Settings			
Network Settings		Basic Settings	
IP Address	192.168.255.1	Alias	CAN FD Gateway
Gateway Address	192.168.0.1		
Subnet Mask	255.255.0.0		
DHCP	Disabled		

The **Forced Reboot** function: can be used to force the ECAN-240-FD to reboot the device.

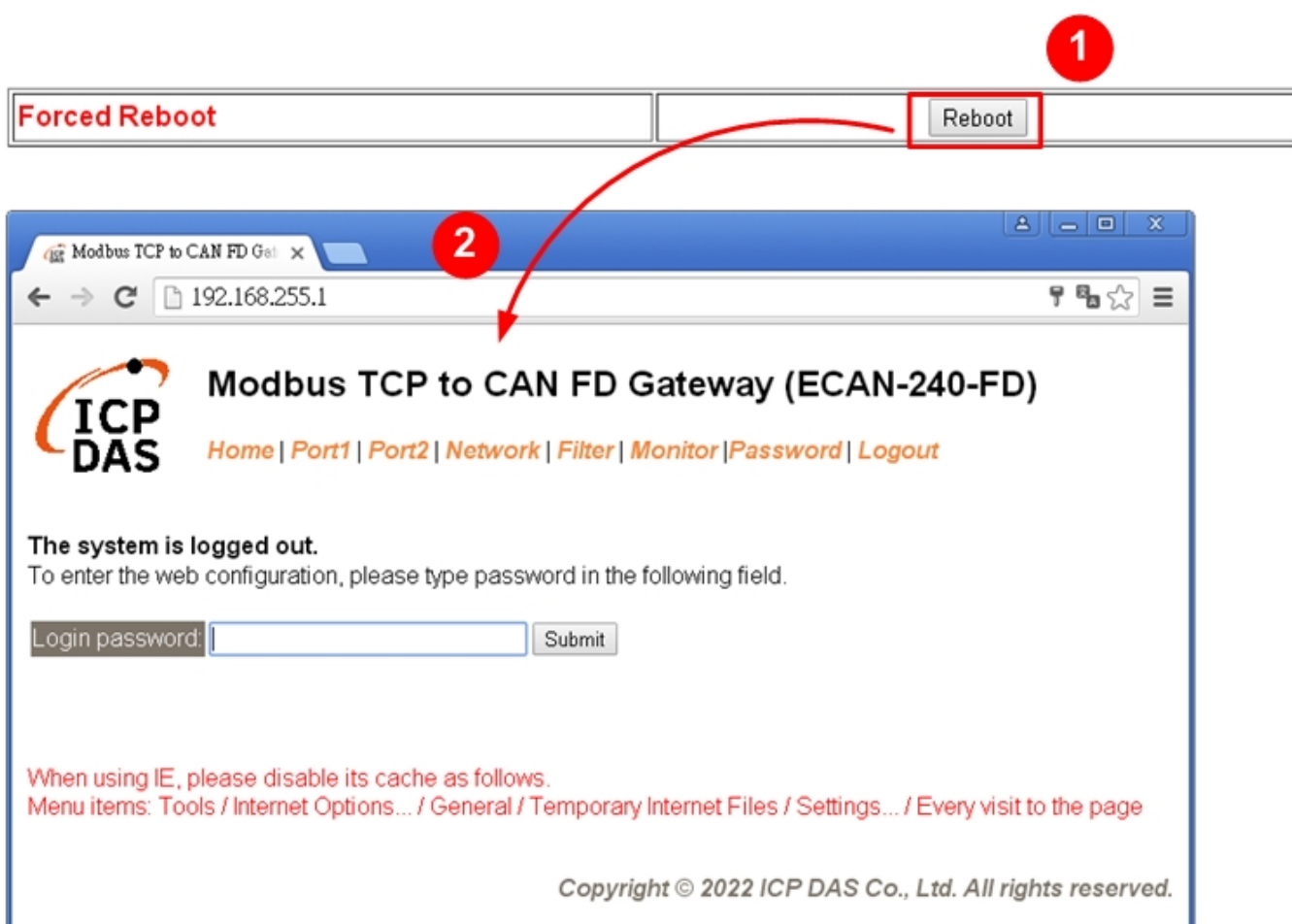

4.4.4. Import/Export Settings

The “Import/Export Settings” provides functionality that allows the user to import settings from an XML file into the module and export settings from the module to an XML file. All settings will take effect after rebooting the device.

Import/Export Settings

Import settings to module	<input type="button" value="選擇檔案"/> <input type="button" value="未選擇任何檔案"/>	<input type="button" value="Import"/>
Export settings from module		<input type="button" value="Export"/>
Note: The "CGI Configuration" setting must be enabled before this feature can be used.		

4.5. Filter Page



Modbus TCP to CAN FD Gateway (ECAN-240-FD)

[Home](#) |
 [Port1](#) |
 [Port2](#) |
 [Network](#) |
 [Filter](#) |
 [Monitor](#) |
 [Password](#) |
 [Logout](#)

Model Name:	ECAN-240-FD	Alias Name:	CAN FD Gateway
Firmware Version:	V2.00 [2023/07/17]	MAC Address:	00-0D-E0-20-00-10
IP Address:	192.168.255.1	Communication Mode:	Modbus TCP Server
Initial Switch:	00	Local Command Port:	502

The Accessible IP Settings page is used to query or edit the IP Filter List. The IP Filter List restricts the access of packets based on the IP header. If one or more IP address are saved to the IP Filter table, only clients whose IP is specified in the IP Filter List can access the ECAN-240-FD.

Accessible IP (filter is disabled when all zero):

IP Filter List	IP Address
IP0:	0.0.0.0
IP1:	0.0.0.0
IP2:	0.0.0.0
IP3:	0.0.0.0
IP4:	0.0.0.0

- Add . . . To The List
 - Add Range . . . & Mask: . . .
 - Delete IP# (Number: 0 ~ 4)
 - Delete ALL
 - Save Configuration (finish)
-

The following is an overview of the parameters contained in the Filter Settings (white list) section:

Item	Description
Add “IP” To The List	Add an IP address to the IP Filter List.
Add Range “IP” & Mask “IP”	Add an IP address range to the IP Filter List.
Delete IP# “Number”	Delete a specific IP# address from the IP Filter List. (Number: 0 ~ 4)
Delete All	Delete all items from the IP Filter List.
Save Configuration (finish)	Save a new IP Filter List to the Flash memory.
Submit	Click this button to save the revised settings to the ECAN-240-FD. All settings will take effect after rebooting the device.

4.6. Monitor Page



Modbus TCP to CAN FD Gateway (ECAN-240-FD)

Home | Port1 | Port2 | Network | Filter | **Monitor** | Password | Logout

Model Name:	ECAN-240-FD	Alias Name:	CAN FD Gateway
Firmware Version:	V2.00 [2023/07/17]	MAC Address:	00-0D-E0-20-00-10
IP Address:	192.168.255.1	Communication Mode:	Modbus TCP Server
Initial Switch:	00	Local Command Port:	502

After clicking the **Monitor** tab, the **Current Status (CAN)** page will be displayed showing detailed information regarding the current status of the CAN port for the ECAN-240-FD module.

Current Status (CAN):

Port Number	Port 1	Port 2
CAN Status:	00000000	00000000
Tx frames per second:	0	0
Rx frames per second:	0	0
Total Tx count:	0	0
Total Rx count:	0	0

CAN Status			
Bit	Symbol	Value	Description
0	RX		CAN1/CAN2 receive software buffer status
		0	Receive software buffer underrun
		1	Receive software buffer overrun
1	TX		CAN1/CAN2 transmit software buffer status
		0	Transmit software buffer underrun
		1	Transmit software buffer overrun
3:2	-		Reserved
4	EW		CAN1/2 Error Warning status.
		0	Both error counters are below the Error Warning limit of 96
		1	At least one of error counter has reached the Error Warning

			limit of 96
5	EP		CAN1/2 Error passive status
		0	The CAN is in Error Active state.
		1	The CAN is in the Error Passive state
6	BO		CAN1/2 Bus Off status
		0	The CAN is not in Bus OFF state.
		1	The CAN is in the Bus OFF state
7	-		Reserved
8	MR		CAN1/CAN2 to Modbus receiver software buffer status
		0	Receive software buffer underrun
		1	Receive software buffer overrun
9	ET		CAN1/CAN2 to Ethernet Transmit software buffer status
		0	Transmit software buffer underrun
		1	Transmit software buffer overrun
31:10	-	-	Reserved

4.7. Password Page

For the first time to use the ECAN-240-FD device or clicking the **Password** tab, the **Change Password** page will be displayed. To change a password, first enter the old password in the **“Current password”** field (use the default password **“admin”**) and then enter a new password in the **“New password”** field. Re-enter the new password in the **“Confirm new password”** field, and then click the **“Submit”** button to update the password.



Note: *If you forgot your password, please refer to [section A1. How to restore the factory default web password of the module?](#)*

4.8. Logout Page

After clicking the **Logout** tab, you will be immediately logged out from the system and be returned to the login page.

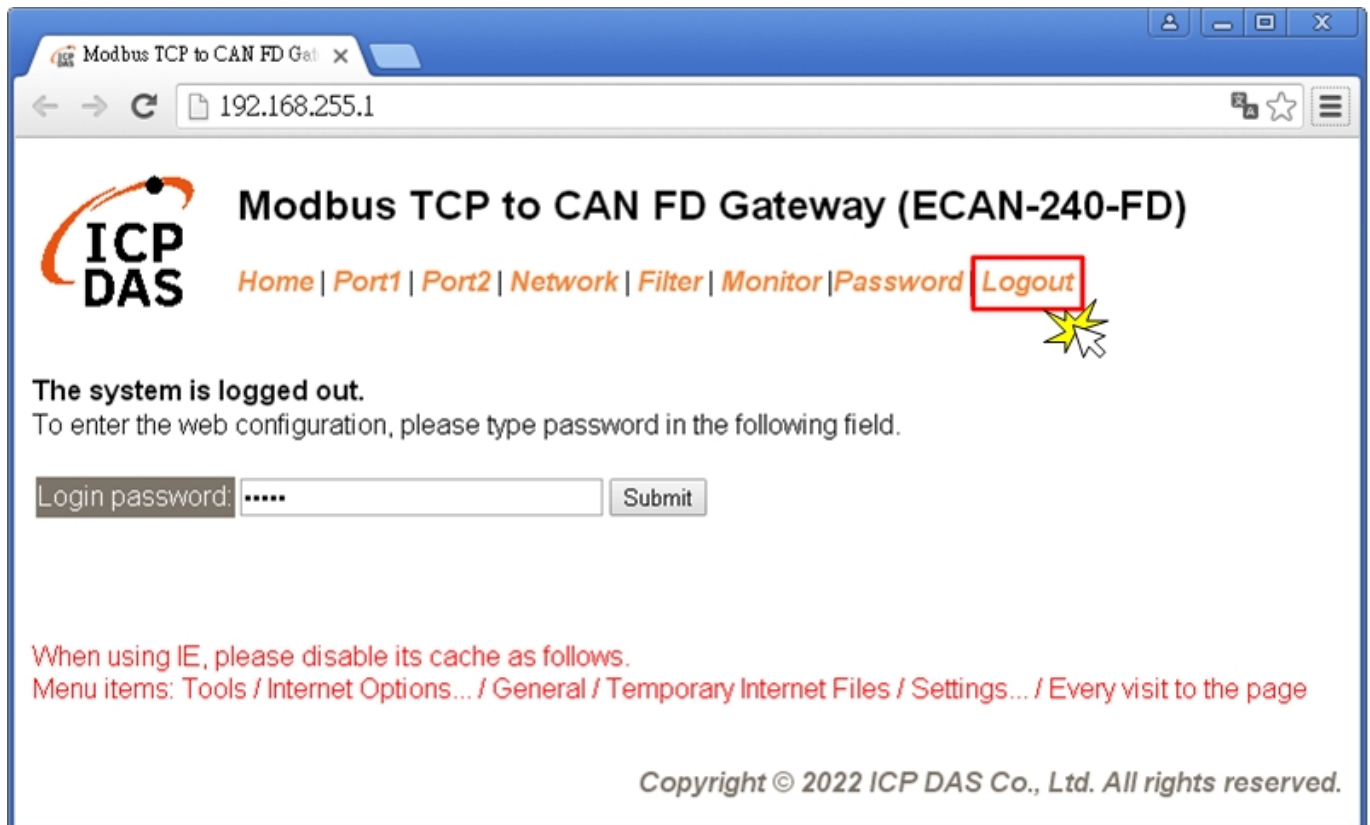

5. CGI Configuration

The ECAN-240-FD can be configured via convenient URL commands. This section lists the commands in URL format corresponding to the basic functions of ECAN-240-FD. Please make sure you have correctly configured the network settings for the ECAN-240-FD before using CGI configuration.

5.1. CGI URL Syntax

Please refer to Sec. 5.2 CGI Command List

Syntax: `http:// <IP address of ECAN-240-FD>/<CGI>?<Parameter Name>=<Value>`

Example: `http://192.168.255.10/assign.cgi?ip=192.168.255.10&gway=192.168.0.1&mask=255.255.0.0`

1. Type the CGI command in the browser.

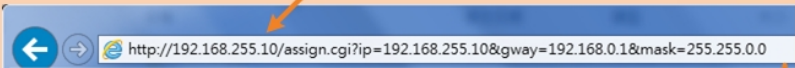

2. Complete

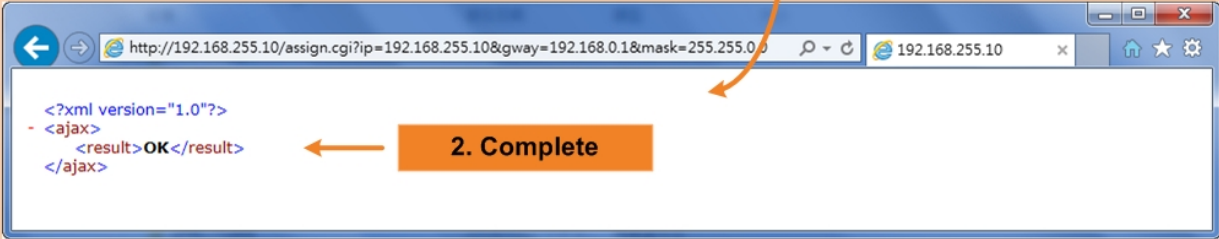

5.2. CGI Command List

Network Settings				
No.	Function Name	Parameter Name	Value Constraint	CGI
01	Set Address Type	dhcp	0,1 0: Disable; 1: Enable;	assign.cgi
02	Set IP Address	ip	xxx.xxx.xxx.xxx	
03	Set Gateway	gway	xxx.xxx.xxx.xxx	
04	Set Net Mask	mask	xxx.xxx.xxx.xxx	
05	Set MAC Address	mac	Format: FF-FF-FF-FF-FF-FF	

Network Filter Settings				
No.	Function Name	Parameter Name	Value Constraint	CGI
01	Add IP to List (white list)	fip0 ~ fip4 fipm0 ~ fipm4 (mask)	xxx.xxx.xxx.xxx	assign.cgi
02	Delete IP#	delfip	0 ~ 4	
03	Delete All	delfip	all	

General Configuration Settings				
No.	Function Name	Parameter Name	Value Constraint	CGI
01	Set operation mode	cctl	0, 1 0: CAN mode; 1: CAN FD mode;	assign.cgi
02	Set communication mode	comm	0, 1, 2 0: Modbus TCP Server 1: TCP Transparent 2: UDP Transparent Default: 0	
03	Set Local Command Port	cmdport	1~65532 Default: 502	
04	Set Command Port	cmdwdt	1~65535 seconds,	

	Timeout (Socket Watchdog)		Default: 180; Disable: 0;
05	Set Transparent Command Interval	cmdintv	1~65535 milliseconds Default: 10 No wait: 0
06	Set Modbus Net ID	netid	1 ~ 247 Default: 1
07	Set remote Device UDP IP	rip	xxx.xxx.xxx.xxx Default: 192.168.255.10
08	Set remote Device UDP Port	rport	1~65535 Default: 10003
09	Set System Timeout	syswdt	30 ~ 65535 seconds, Default: 300; Disable: 0
10	Set Alias Name	aliname	Max. 18 chars Default: "CAN FD Gateway"
11	Set HTTP port	hport	1~65532 Default: 80
12	Set Web password	webpwd	Max. 11 chars Default: "admin"
13	Set assign CGI function	acgi	0,1 0: Disable; 1: Enable; Default: 1
14	Set UDP Search function	ucfg	0,1 0: Disable; 1: Enable; Default: 1

CAN Port Settings (Parameter Name → 0: CAN1, 1: CAN2)				
No.	Function Name	Parameter Name	Value Constraint	CGI
01	Set CAN FD specification	cspec0 & cspec1	0, 1 0: ISO mode; 1: Non-ISO mode; Default: 0	assign.cgi
02	Set CAN arbitration bit rate	cabr0 & cabr1	10,000~1,000,000 bps Default: 1,000,000 bps;	
03	Set CAN FD data phase bit rate	cdbr0 & cdbr1	100,000~10,000,000 bps Default: 1,000,000 bps;	
04	Set CAN arbitration bit rate sample point	casp0 & casp1	1.00~99.00 (%) Default: 87.50 (%);	
05	Set CAN FD data phase bit rate sample point	cdsp0 & cdsp1	1.00~99.00 (%) Default: 87.50 (%);	
06	Reject remote standard ID	crsf0 & crsf1	0,1 0: Disable; 1: Enable;	
07	Reject remote extended ID	cref0 & cref1	0,1 0: Disable; 1: Enable;	
08	Set CAN standard ID filter	csidf0 & csidf1	000~7FF (hexadecimal format) Default: 000;	
09	Set CAN standard ID mask	csidm0 & csidm1	000~7FF (hexadecimal format) Default: 000;	
10	Set CAN extended ID filter	ceidf0 & ceidf1	00000000~1FFFFFFF (hexadecimal format) Default: 00000000;	
11	Set CAN extended ID mask	ceidm0 & ceidm1	00000000~1FFFFFFF (hexadecimal format) Default: 00000000;	

12	Set specific CAN ID Mapping function	scide0 & scide1	0,1 0: Disable; 1: Enable; Default: 0	
----	--------------------------------------	-----------------	--	--

Reset CAN Port status (Parameter Name → 0: CAN1, 1: CAN2)

No.	Function Name	Parameter Name	Value Constraint	CGI
01	Clear CAN port tx/rx data lost status	clr0 & clr1	1 1: clear	assign.cgi

Specific CAN ID Settings

No.	Function Name	Parameter Name	Value Constraint	CGI
01	Set CAN1 #00~29 specific CAN id format	scid0f00, scid0f01, ... scid0f29	0, 1, 2 ; 0: no used; 1: 11-bit CAN id 2: 29-bit CAN id	assign.cgi
02	Set CAN2 #00~29 specific CAN id format	scid1f00, scid1f01, ... scid1f29	0, 1, 2 ; 0: no used; 1: 11-bit CAN id 2: 29-bit CAN id	
03	Set CAN1 #00~29 specific CAN id	scid0i00, scid0i01, ... scid0i29	CAN id format = 1 (11-bit CAN id): 000 ~ 7FF CAN id format = 2 (29-bit CAN id): 00000000 ~ 1FFFFFFF	
04	Set CAN2 #00~29 specific CAN id	scid1i00, scid1i01, ... scid1i29	CAN id format = 1 (11-bit CAN id): 000 ~ 7FF CAN id format = 2 (29-bit CAN id): 00000000 ~ 1FFFFFFF	

Restore Factory Defaults				
No.	Function Name	Parameter Name	Value Constraint	CGI
01	Reboot device	-	-	reboot.cgi
02	Reset all parameters To Factory (No reboot device)	-	-	reset.cgi

Queries Setting Status				
No.	Function Name	Parameter Name	Value Constraint	CGI
01	Get module status.	-	-	status.cgi
02	Get the CAN port configuration information.	-	-	conf_port.cgi
03	Get the network configuration information.	-	-	conf_net.cgi
04	Get the CAN1 specific CAN ID information.	-	-	conf_p1sid.cgi
05	Get the CAN2 specific CAN ID information	-	-	conf_p2sid.cgi

6. Modbus Information

The ECAN-240-FD supports the Modbus TCP protocol when its communication mode is "Modbus TCP Server". Users can use the following two Modbus function codes (0x04 and 0x10) to communicate with it and get/set CAN/CAN FD messages.

Code	Function	Description
04 (0x04)	Read the Input Registers	This function code is used to read either the input registers of received CAN/CAN FD messages or the current CAN bus status in input data area.
16 (0x10)	Preset Multiple Registers	This function code is used to set multiple output registers that are used to store one or many CAN/CAN FD messages that want to be transmitted out in output data area

6.1. Modbus/CAN Mapping Table

When the “Operation Mode” setting is “CAN” mode, users can access the CAN messages by using these Modbus address defined by ECAN-240-FD module. These Modbus address can be divided into two parts as below.

- Input Data Area (access by Modbus Function Code 0x04)
- Output Data Area (access by Modbus Function Code 0x10)

Input/Output Data to data field of Modbus command is transmitted in 8-, 16- and 32-bit format. The data for 16-bit registers is transmitted in high-byte first format. For example: 0x0A0B → 0x0A, 0x0B. The data for 32-bit registers is transmitted as two 16-bit registers, and is high-word first. For example: 0x0A0B0C0D → 0x0A, 0x0B, 0x0C, 0x0D.

6.1.1 Input Data Area

The “Input Data Area” including “CAN Rx FIFO”, “CAN Status” and “CAN Rx Buffer” information for user to use Modbus Function Code 0x04 to get CAN messages and CAN status from ECAN-240-FD.

Input Data Area of ECAN-240-FD (CAN Mode)	
Protocol Base Address (0xxxx)	Description
00000 ~ 00089	CAN1 Rx FIFO Message #1 ~ #10
Reserved	
00512 ~ 00519	CAN1 Status
Reserved	
01024 ~ 02223	CAN1 Rx Buffer Message #00 ~ #29
Reserved	
04096 ~ 04185	CAN2 Rx FIFO Message #1~ #10
Reserved	
04608 ~ 04615	CAN2 Status
Reserved	
05120 ~ 05389	CAN2 Rx Buffer Message #0 ~ #29
Reserved	
08193 ~ 08194	Others: Firmware version, rotary switch value...etc.

6.1.1.1 CAN Rx Message Format

The content of CAN Rx message in the Rx FIFO/Buffer is described in below table. Each CAN Rx message will occupy 9 words space of the Modbus address.

CAN Rx Frame Format (CAN Mode)		
Word No	Description	Note
1	Bit 15: Valid CAN message (1:Valid) Bit 6~14: Reserved Bit 5: xtd (CAN Frame Type, 0:STD or 1:EXT) Bit 4: rtr (CAN Frame Type, 0:DATA or 1:REMOTE) Bit 0~3: dlc (Data Length Code) *NOTE1	STD: standard frame (11-bit CAN id) EXT: extended frame (29-bit CAN id)
2, 3	Bit 29~31: Reserved Bit 0~28: id (CAN Frame Identifier)	
4	CAN Data 0, 1	High Byte: Data 0, Low Byte: Data 1
5	CAN Data 2, 3	
6	CAN Data 4, 5	
7	CAN Data 6, 7	
8	Receive frame timestamp in milliseconds	high word
9	Receive frame timestamp in milliseconds	low word

***NOTE1:** dlc (Data Length Code) of CAN frame data length

dlc (Hexadecimal)	Frame data length (Decimal)
0x0	0
0x1	1
0x2	2
0x3	3
0x4	4
0x5	5
0x6	6
0x7	7

6.1.1.2 CAN Rx FIFO Address

The CAN1/2 port support CAN Rx FIFO. By using Modbus function code 0x04 read command to read the protocol base address of “0” or “4096” and data length in multiples of 9 words, user can get maximum 10 CAN Messages from CAN1/2 Rx FIFO at one time.

CAN1 Rx FIFO Message #1 ~ #10			
Protocol Base Address (0xxxx)	PLC Base Address (3xxxx)	Words	Description
00000 ~ 00089	30001 ~ 30090	9 * 10	CAN1 Rx FIFO Message #1 ~ #10 (N: 1~10) Read “Protocol Base Address: 00000” and “Word No: 9 * N”, you can get N CAN messages from CAN1 Rx FIFO (N: maximum 10 messages). When there is no data in Rx FIFO #N, the corresponding 9 words data content will be 0.
CAN2 Rx FIFO Message #1 ~ #10			
Protocol Base Address (0xxxx)	PLC Base Address (3xxxx)	Words	Description
04096 ~ 04185	34097 ~ 34186	9 * 10	CAN2 Rx FIFO Message #1~ #10 (N: 1~10) Read “Protocol Base Address: 04096” and “Word No 9 * N”, you can get N CAN messages from CAN2 Rx FIFO (N: maximum 10 messages). When there is no data in Rx FIFO #N, the corresponding 9 words data content will be 0.

6.1.1.3 CAN Status Address

Status information of CAN1/2 ports, including CAN bus status, CAN FIFO overflow status, CAN Tx/Rx frame count and FPS (frame per second).

CAN1 Status			
Protocol Base Address (0xxxx)	PLC Base Address (3xxxx)	Words	Description
00512 ~ 00513	30513 ~ 30514	2	CAN1 Status Bit 10-31: reserved Bit 9: Ethernet Tx FIFO overflow Bit 8: Modbus Rx FIFO overflow Bit 7: reserved Bit 6: CAN bus off Bit 5: CAN error passive Bit 4: CAN error warning Bit 2-3: reserved Bit 1: CAN Tx FIFO overflow Bit 0: CAN Rx FIFO overflow
00514 ~ 00515	30515 ~ 30516	2	CAN1 Tx data count
00516 ~ 00517	30517 ~ 30518	2	CAN1 Rx data count
00518 ~ 00518	30519 ~ 30519	1	CAN1 Tx FPS (frame per second)
00519 ~ 00519	30520 ~ 30520	1	CAN1 Rx FPS (frame per second)
CAN2 Status			
Protocol Base Address (0xxxx)	PLC Base Address (3xxxx)	Words	Description
04608 ~ 04609	34609 ~ 34610	2	CAN2 Status Bit 10-31: reserved Bit 9: Ethernet Tx FIFO overflow Bit 8: Modbus Rx FIFO overflow

			Bit 7: reserved Bit 6: CAN bus off Bit 5: CAN error passive Bit 4: CAN error warning Bit 2-3: reserved Bit 1: CAN Tx FIFO overflow Bit 0: CAN Rx FIFO overflow
04610 ~ 04611	34611 ~ 34612	2	CAN2 Tx data count
04612 ~ 04613	34613 ~ 34614	2	CAN2 Rx data count
04614 ~ 04614	34615 ~ 34615	1	CAN2 Tx FPS
04615 ~ 04615	34616 ~ 34616	1	CAN2 Rx FPS

6.1.1.4 CAN Rx Buffer Address

The CAN1/2 port support CAN Rx Buffer. When enable the “**Spec. CAN ID Mode**” and the received CAN frame matched the “Specific CAN ID” setting (refer to [Section 4.3.2 Sepecific CAN ID Settings](#)), this CAN frame will be saved into the relative “CAN Rx Buffer” (if there is no match, this CAN frame will be saved in the “CAN FD Rx FIFO”). By using Modbus function code 0x04 read command to read the protocol base address of “1024~1293” and “5120~5389”, user can get the received CAN message from CAN1/2 Rx Buffer.

CAN1 Rx Buffer Message #00 ~ #29			
Protocol Base Address (0xxxx)	PLC Base Address (3xxxx)	Words	Description
01024 ~ 01032	31025 ~ 31033	9	CAN1 Rx Buffer Message #00
01033 ~ 01041	31034 ~ 31042	9	CAN1 Rx Buffer Message #01
01042 ~ 01050	31043 ~ 31051	9	CAN1 Rx Buffer Message #02
01051 ~ 01059	31052 ~ 31060	9	CAN1 Rx Buffer Message #03
01060 ~ 01068	31061 ~ 31069	9	CAN1 Rx Buffer Message #04
01069 ~ 01077	31070 ~ 31078	9	CAN1 Rx Buffer Message #05
01078 ~ 01086	31079 ~ 31087	9	CAN1 Rx Buffer Message #06
01087 ~ 01095	31088 ~ 31096	9	CAN1 Rx Buffer Message #07
01096 ~ 01104	31097 ~ 31105	9	CAN1 Rx Buffer Message #08
01105 ~ 01113	31106 ~ 31114	9	CAN1 Rx Buffer Message #09
01114 ~ 01122	31115 ~ 31123	9	CAN1 Rx Buffer Message #10
01123 ~ 01131	31124 ~ 31132	9	CAN1 Rx Buffer Message #11
01132 ~ 01140	31133 ~ 31141	9	CAN1 Rx Buffer Message #12
01141 ~ 01149	31142 ~ 31150	9	CAN1 Rx Buffer Message #13
01150 ~ 01158	31151 ~ 31159	9	CAN1 Rx Buffer Message #14
01159 ~ 01167	31160 ~ 31168	9	CAN1 Rx Buffer Message #15
01168 ~ 01176	31169 ~ 31177	9	CAN1 Rx Buffer Message #16
01177 ~ 01185	31178 ~ 31186	9	CAN1 Rx Buffer Message #17
01186 ~ 01194	31187 ~ 31195	9	CAN1 Rx Buffer Message #18
01195 ~ 01203	31196 ~ 31204	9	CAN1 Rx Buffer Message #19
01204 ~ 01212	31205 ~ 31213	9	CAN1 Rx Buffer Message #20
01213 ~ 01221	31214 ~ 31222	9	CAN1 Rx Buffer Message #21

01222 ~ 01230	31223 ~ 31231	9	CAN1 Rx Buffer Message #22
01231 ~ 01239	31232 ~ 31240	9	CAN1 Rx Buffer Message #23
01240 ~ 01248	31241 ~ 31249	9	CAN1 Rx Buffer Message #24
01249 ~ 01257	31250 ~ 31258	9	CAN1 Rx Buffer Message #25
01258 ~ 01266	31259 ~ 31267	9	CAN1 Rx Buffer Message #26
01267 ~ 01275	31268 ~ 31276	9	CAN1 Rx Buffer Message #27
01276 ~ 01284	31277 ~ 31285	9	CAN1 Rx Buffer Message #28
01285 ~ 01293	31286 ~ 31294	9	CAN1 Rx Buffer Message #29
CAN2 Rx Buffer Message #00 ~ #29			
Protocol Base Address (0xxxx)	PLC Base Address (3xxxx)	Words	Description
05120 ~ 05128	35121 ~ 35129	9	CAN2 Rx Buffer Message #00
05129 ~ 05137	35130 ~ 35138	9	CAN2 Rx Buffer Message #01
05138 ~ 05146	35139 ~ 35147	9	CAN2 Rx Buffer Message #02
05147 ~ 05155	35148 ~ 35156	9	CAN2 Rx Buffer Message #03
05156 ~ 05164	35157 ~ 35165	9	CAN2 Rx Buffer Message #04
05165 ~ 05173	35166 ~ 35174	9	CAN2 Rx Buffer Message #05
05174 ~ 05182	35175 ~ 35183	9	CAN2 Rx Buffer Message #06
05183 ~ 05191	35184 ~ 35192	9	CAN2 Rx Buffer Message #07
05192 ~ 05200	35193 ~ 35201	9	CAN2 Rx Buffer Message #08
05201 ~ 05209	35202 ~ 35210	9	CAN2 Rx Buffer Message #09
05210 ~ 05218	35211 ~ 35219	9	CAN2 Rx Buffer Message #10
05219 ~ 05227	35220 ~ 35228	9	CAN2 Rx Buffer Message #11
05228 ~ 05236	35229 ~ 35237	9	CAN2 Rx Buffer Message #12
05237 ~ 05245	35238 ~ 35246	9	CAN2 Rx Buffer Message #13
05246 ~ 05254	35247 ~ 35255	9	CAN2 Rx Buffer Message #14
05255 ~ 05263	35256 ~ 35264	9	CAN2 Rx Buffer Message #15
05264 ~ 05272	35265 ~ 35273	9	CAN2 Rx Buffer Message #16
05273 ~ 05281	35274 ~ 35282	9	CAN2 Rx Buffer Message #17
05282 ~ 05290	35283 ~ 35291	9	CAN2 Rx Buffer Message #18
05291 ~ 05299	35292 ~ 35300	9	CAN2 Rx Buffer Message #19
05300 ~ 05308	35301 ~ 35309	9	CAN2 Rx Buffer Message #20
05309 ~ 05317	35310 ~ 35318	9	CAN2 Rx Buffer Message #21

05318 ~ 05326	35319 ~ 35327	9	CAN2 Rx Buffer Message #22
05327 ~ 05335	35328 ~ 35336	9	CAN2 Rx Buffer Message #23
05336 ~ 05344	35337 ~ 35345	9	CAN2 Rx Buffer Message #24
05345 ~ 05353	35346 ~ 35354	9	CAN2 Rx Buffer Message #25
05354 ~ 05362	35355 ~ 35363	9	CAN2 Rx Buffer Message #26
05363 ~ 05371	35364 ~ 35372	9	CAN2 Rx Buffer Message #27
05372 ~ 05380	35373 ~ 35381	9	CAN2 Rx Buffer Message #28
05381 ~ 05389	35382 ~ 35390	9	CAN2 Rx Buffer Message #29

6.1.1.5 Others

“Others” information, including firmware version and rotary switch values of ECAN-240-FD module.

Others			
Protocol Base Address (0xxxx)	PLC Base Address (3xxxx)	Words	Description
08193 ~ 08193	38194 ~ 38194	1	Firmware Version
08194 ~ 08194	38195 ~ 38195	1	Rotary Switch Values of SW2/SW1

6.1.2 Output Data Area

The “Output Data Area” including “CAN Tx FIFO”, “Reboot System”, “Restore default setting” and “Clear CAN status” information for user to use Modbus Function Code 0x10 to set CAN Tx messages and module status of ECAN-240-FD.

Output Data Area of ECAN-240-FD (CAN Mode)	
Protocol Base Address (0xxxx)	Description
00000 ~ 00034	CAN1 Tx FIFO Message #1 ~ #5
Reserved	
01024 ~ 01058	CAN2 Tx FIFO Message #1 ~ #5
Reserved	
02049 ~ 02052	Others “System Reboot”, “Restore default setting”, Clear CAN status ... etc

6.1.2.1 CAN Tx Message Format

The content of CAN Tx message in the Tx FIFO is described in below table. Each CAN Tx message will occupy 7 words space of the Modbus address.

CAN Tx Frame Format		
Word No	Description	Note
1	Bit 6~15:Reserved Bit 5: xtd (CAN Frame Type, 0:STD or 1:EXT) Bit 4: rtr (CAN Frame Type, 0:DATA or 1:REMOTE) Bit 0~3: dlc (Data Length Code) *NOTE1	STD: standard frame (11-bit CAN id) EXT: extended frame (29-bit CAN id)
2, 3	Bit 29~31: Reserved Bit 0~28: id (CAN Frame Identifier)	CAN ID
4	CAN Data 0, 1 (High Byte: Data0, Low Byte: Data 1)	CAN Data
5	CAN Data 2, 3	
6	CAN Data 4, 5	
7	CAN Data 6, 7	

***NOTE1:** dlc (Data Length Code) of CAN frame data length

dlc (Hexadecimal)	Frame data length (Decimal)
0x0	0
0x1	1
0x2	2
0x3	3
0x4	4
0x5	5
0x6	6
0x7	7

6.1.2.2 CAN Tx FIFO Address

The CAN1/2 port support CAN Tx FIFO. By using Modbus function code 0x10 write command to write the protocol base address of “0” or “1024” and the data length in multiples of 7 words, user can set maximum 5 CAN Messages to CAN1/2 Tx FIFO at one time.

CAN1 Tx FIFO Message #1 ~ #5			
Protocol Base Address (0xxxx)	PLC Base Address (4xxxx)	Words	Description
00000 ~ 00034	40001 ~ 40035	7 * 5	CAN1 Tx FIFO Message #1 ~ #5 (N: 1~5) Write “Protocol Base Address: 00000” and “Word No: 7 * N”, you can set N CAN messages to CAN1 Tx FIFO (N: maximum 5 messages).
CAN2 Tx FIFO Message #1 ~ #5			
Protocol Base Address (0xxxx)	PLC Base Address (4xxxx)	Words	Description
01024 ~ 01058	41025 ~ 41059	7 * 5	CAN2 Tx FIFO Message #1~ #5 (N: 1~5) Write “Protocol Base Address: 01024” and “Word No: 7 * N”, you can set N CAN messages to CAN2 Tx FIFO (N: maximum 5 messages).

6.1.2.3 Others

“Others” information, including “Reboot system”, “Restore default setting” and “Clear CAN status” of ECAN-240-FD module.

Others			
Protocol Base Address (0xxxx)	PLC Base Address (4xxxx)	Words	Description
02049 ~ 02049	42050 ~ 42050	1	System Reboot 0x55AA: Reboot system Others: do nothing
02050 ~ 02050	42051 ~ 42051	1	Restore default setting 0x55AA: Restore default Others: do nothing
02051 ~ 02051	42052 ~ 42052	1	Clear CAN1 status 1: clear Others: do nothing
02052 ~ 02052	42053 ~ 42053	1	Clear CAN2 status 1: clear Others: do nothing

6.2. Modbus/CAN FD Mapping Table

When the “Operation Mode” setting is “CAN FD” mode, users can access the CAN FD messages by using these Modbus address defined by ECAN-240-FD module. These Modbus address can be divided into two parts as below.

- Input Data Area (access by Modbus Function Code 0x04)
- Output Data Area (access by Modbus Function Code 0x10)

Input/Output Data to data field of Modbus command is transmitted in 8-, 16- and 32-bit format. The data for 16-bit registers is transmitted in high-byte first format. For example: 0x0A0B → 0x0A, 0x0B. The data for 32-bit registers is transmitted as two 16-bit registers, and is high-word first. For example: 0x0A0B0C0D → 0x0A, 0x0B, 0x0C, 0x0D.

6.2.1 Input Data Area

The “Input Data Area” including “CAN Rx FIFO”, “CAN Status” and “CAN Rx Buffer” information for user to use Modbus Function Code 0x04 to get CAN FD messages and CAN status from ECAN-240-FD.

Input Data Area of ECAN-240-FD (CAN FD Mode)	
Protocol Base Address (0xxxx)	Description
00000 ~ 00399	CAN1 Rx FIFO Message #1 ~ #10
Reserved	
00512 ~ 00519	CAN1 Status
Reserved	
01024 ~ 02223	CAN1 Rx Buffer Message #0 ~ #29
Reserved	
04096 ~ 04495	CAN2 Rx FIFO Message #1~ #10
Reserved	
04608 ~ 04615	CAN2 Status
Reserved	
05120 ~ 06319	CAN2 Rx Buffer Message #0 ~ #29
Reserved	
08193 ~ 08194	Others: Firmware version, rotary switch value...etc.

6.2.1.1 CAN FD Rx Message Format

The content of CAN FD Rx message in the Rx FIFO/Buffer is described in below table.
Each CAN FD Rx message will occupy 40 words space of the Modbus address.

CAN Rx Frame Format (CAN FD Mode)		
Word No	Description	Note
1, 2	Bit 31:Valid CAN message (1:Valid) Bit 8~30:Reserved Bit 7: fdf (CAN FD format, 0:CAN or 1: CANFD) Bit 6: brs (Bit Rate Switch, 1:Switch) Bit 5: xtd (CAN Frame Type, 0:STD or 1:EXT) Bit 4: rtr (CAN Frame Type, 0:DATA or 1:REMOTE) Bit 0~3: dlc (Data Length Code) *NOTE1	STD: standard frame (11-bit CAN id) EXT: extended frame (29-bit CAN id)
3, 4	Bit 29~31: Reserved Bit 0~28: id (CAN Frame Identifier)	
5	CAN Data 0, 1 (High Byte: Data0, Low Byte: Data 1)	
6	CAN Data 2, 3	
7	CAN Data 4, 5	
8	CAN Data 6, 7	
9	CAN Data 8, 9	No used for CAN frame
10	CAN Data 10, 11	
11	CAN Data 12, 13	
12	CAN Data 14, 15	
13	CAN Data 16, 17	
14	CAN Data 18, 19	
15	CAN Data 20, 21	
16	CAN Data 22, 23	
17	CAN Data 24, 25	
18	CAN Data 26, 27	
19	CAN Data 28, 29	
20	CAN Data 30, 31	
21	CAN Data 32, 33	
22	CAN Data 34, 35	
23	CAN Data 36, 37	
24	CAN Data 38, 39	
25	CAN Data 40, 41	
26	CAN Data 42, 43	
27	CAN Data 44, 45	
28	CAN Data 46, 47	
29	CAN Data 48, 49	
30	CAN Data 50, 51	
31	CAN Data 52, 53	
32	CAN Data 54, 55	
33	CAN Data 56, 57	

34	CAN Data 58, 59	
35	CAN Data 60, 61	
36	CAN Data 62, 63	
37, 38	Sec (Receive frame timestamp in seconds)	
39, 40	Usec (Receive frame timestamp in micro-seconds)	

***NOTE1:** dlc (Data Length Code) of CAN FD frame data length

dlc (Hexadecimal)	Frame data length (Decimal)	dlc (Hexadecimal)	Frame data length (Decimal)
0x0	0	0x8	8
0x1	1	0x9	12
0x2	2	0xA	16
0x3	3	0xB	20
0x4	4	0xC	24
0x5	5	0xD	32
0x6	6	0xE	48
0x7	7	0xF	64

6.2.1.2 CAN FD Rx FIFO Address

The CAN1/2 port support CAN FD Rx FIFO. By using Modbus function code 0x04 read command to read the protocol base address of “0” or “4096” and data length in multiples of 40 words, user can get maximum 10 CAN FD Messages from CAN1/2 Rx FIFO at one time.

CAN1 Rx FIFO Message #1 ~ #10			
Protocol Base Address (0xxxx)	PLC Base Address (3xxxx)	Words	Description
00000 ~ 00399	30001 ~ 30400	40 * 10	CAN1 Rx FIFO Message #1 ~ #10 (N: 1~10) Read “Protocol Base Address: 00000” and “Word No: 40 * N”, you can get N CAN messages from CAN1 Rx FIFO (N: maximum 10 messages). When there is no data in Rx FIFO #N, the corresponding 40 words data content will be 0.
CAN2 Rx FIFO Message #1 ~ #10			
Protocol Base Address (0xxxx)	PLC Base Address (3xxxx)	Words	Description
04096 ~ 04495	34097 ~ 34496	40 * 10	CAN2 Rx FIFO Message #1~ #10 (N: 1~10) Read “Protocol Base Address: 04096” and “Word No 40 * N”, you can get N CAN messages from CAN2 Rx FIFO (N: maximum 10 messages). When there is no data in Rx FIFO #N, the corresponding 40 words data content will be 0.

6.2.1.3 CAN Status Address

Status information of CAN1/2 ports, including CAN bus status, CAN FIFO overflow status, CAN Tx/Rx frame count and FPS (frame per second).

CAN1 Status			
Protocol Base Address (0xxxx)	PLC Base Address (3xxxx)	Words	Description
00512 ~ 00513	30513 ~ 30514	2	CAN1 Status Bit 10-31: reserved Bit 9: Ethernet Tx FIFO overflow Bit 8: Modbus Rx FIFO overflow Bit 7: reserved Bit 6: CAN bus off Bit 5: CAN error passive Bit 4: CAN error warning Bit 2-3: reserved Bit 1: CAN Tx FIFO overflow Bit 0: CAN Rx FIFO overflow
00514 ~ 00515	30515 ~ 30516	2	CAN1 Tx data count
00516 ~ 00517	30517 ~ 30518	2	CAN1 Rx data count
00518 ~ 00518	30519 ~ 30519	1	CAN1 Tx FPS (frame per second)
00519 ~ 00519	30520 ~ 30520	1	CAN1 Rx FPS (frame per second)
CAN2 Status			
Protocol Base Address (0xxxx)	PLC Base Address (3xxxx)	Words	Description
04608 ~ 04609	34609 ~ 34610	2	CAN2 Status Bit 10-31: reserved Bit 9: Ethernet Tx FIFO overflow Bit 8: Modbus Rx FIFO overflow

			Bit 7: reserved Bit 6: CAN bus off Bit 5: CAN error passive Bit 4: CAN error warning Bit 2-3: reserved Bit 1: CAN Tx FIFO overflow Bit 0: CAN Rx FIFO overflow
04610 ~ 04611	34611 ~ 34612	2	CAN2 Tx data count
04612 ~ 04613	34613 ~ 34614	2	CAN2 Rx data count
04614 ~ 04614	34615 ~ 34615	1	CAN2 Tx FPS
04615 ~ 04615	34616 ~ 34616	1	CAN2 Rx FPS

6.2.1.4 CAN FD Rx Buffer Address

The CAN1/2 port support CAN Rx Buffer. When enable “**Spec. CAN ID Mode**” and the received CAN frame matched the “Specific CAN ID” setting (refer to [Section 4.3.2 Sepecific CAN ID Settings](#)), this CAN frame will be saved into the relative “CAN FD Rx Buffer” (if there is no match, this CAN frame will be saved in the “CAN FD Rx FIFO”). By using Modbus function code 0x04 read command to read the protocol base address of “1024~2223” and “5120~6319”, user can get the received CAN FD message from CAN1/2 Rx Buffer.

CAN1 Rx Buffer Message #00 ~ #29			
Protocol Base Address (0xxxx)	PLC Base Address (3xxxx)	Words	Description
01024 ~ 01063	31025 ~ 31064	40	CAN1 Rx Buffer Message #00
01064 ~ 01103	31065 ~ 31104	40	CAN1 Rx Buffer Message #01
01104 ~ 01143	31105 ~ 31144	40	CAN1 Rx Buffer Message #02
01144 ~ 01183	31145 ~ 31184	40	CAN1 Rx Buffer Message #03
01184 ~ 01223	31185 ~ 31224	40	CAN1 Rx Buffer Message #04
01224 ~ 01263	31225 ~ 31264	40	CAN1 Rx Buffer Message #05
01264 ~ 01303	31265 ~ 31304	40	CAN1 Rx Buffer Message #06
01304 ~ 01343	31305 ~ 31344	40	CAN1 Rx Buffer Message #07
01344 ~ 01383	31345 ~ 31384	40	CAN1 Rx Buffer Message #08
01384 ~ 01423	31385 ~ 31424	40	CAN1 Rx Buffer Message #09
01424 ~ 01463	31425 ~ 31464	40	CAN1 Rx Buffer Message #10
01464 ~ 01503	31465 ~ 31504	40	CAN1 Rx Buffer Message #11
01504 ~ 01543	31505 ~ 31544	40	CAN1 Rx Buffer Message #12
01544 ~ 01583	31545 ~ 31584	40	CAN1 Rx Buffer Message #13
01584 ~ 01623	31585 ~ 31624	40	CAN1 Rx Buffer Message #14
01624 ~ 01663	31625 ~ 31664	40	CAN1 Rx Buffer Message #15
01664 ~ 01703	31665 ~ 31704	40	CAN1 Rx Buffer Message #16
01704 ~ 01743	31705 ~ 31744	40	CAN1 Rx Buffer Message #17
01744 ~ 01783	31745 ~ 31784	40	CAN1 Rx Buffer Message #18
01784 ~ 01823	31785 ~ 31824	40	CAN1 Rx Buffer Message #19
01824 ~ 01863	31825 ~ 31864	40	CAN1 Rx Buffer Message #20
01864 ~ 01903	31865 ~ 31904	40	CAN1 Rx Buffer Message #21

01904 ~ 01943	31905 ~ 31944	40	CAN1 Rx Buffer Message #22
01944 ~ 01983	31945 ~ 31984	40	CAN1 Rx Buffer Message #23
01984 ~ 02023	31985 ~ 32024	40	CAN1 Rx Buffer Message #24
02024 ~ 02063	32025 ~ 32064	40	CAN1 Rx Buffer Message #25
02064 ~ 02103	32065 ~ 32104	40	CAN1 Rx Buffer Message #26
02104 ~ 02143	32105 ~ 32144	40	CAN1 Rx Buffer Message #27
02144 ~ 02183	32145 ~ 32184	40	CAN1 Rx Buffer Message #28
02184 ~ 02223	32185 ~ 32224	40	CAN1 Rx Buffer Message #29
CAN2 Rx Buffer Message #00 ~ #29			
Protocol Base Address (0xxxx)	PLC Base Address (3xxxx)	Words	Description
05120 ~ 05159	35121 ~ 35160	40	CAN2 Rx Buffer Message #0
05160 ~ 05199	35161 ~ 35200	40	CAN2 Rx Buffer Message #1
05200 ~ 05239	35201 ~ 35240	40	CAN2 Rx Buffer Message #2
05240 ~ 05279	35241 ~ 35280	40	CAN2 Rx Buffer Message #3
05280 ~ 05319	35281 ~ 35320	40	CAN2 Rx Buffer Message #4
05320 ~ 05359	35321 ~ 35360	40	CAN2 Rx Buffer Message #5
05360 ~ 05399	35361 ~ 35400	40	CAN2 Rx Buffer Message #6
05400 ~ 05439	35401 ~ 35440	40	CAN2 Rx Buffer Message #7
05440 ~ 05479	35441 ~ 35480	40	CAN2 Rx Buffer Message #8
05480 ~ 05519	35481 ~ 35520	40	CAN2 Rx Buffer Message #9
05520 ~ 05559	35521 ~ 35560	40	CAN2 Rx Buffer Message #10
05560 ~ 05599	35561 ~ 35600	40	CAN2 Rx Buffer Message #11
05600 ~ 05639	35601 ~ 35640	40	CAN2 Rx Buffer Message #12
05640 ~ 05679	35641 ~ 35680	40	CAN2 Rx Buffer Message #13
05680 ~ 05719	35681 ~ 35720	40	CAN2 Rx Buffer Message #14
05720 ~ 05759	35721 ~ 35760	40	CAN2 Rx Buffer Message #15
05760 ~ 05799	35761 ~ 35800	40	CAN2 Rx Buffer Message #16
05800 ~ 05839	35801 ~ 35840	40	CAN2 Rx Buffer Message #17
05840 ~ 05879	35841 ~ 35880	40	CAN2 Rx Buffer Message #18
05880 ~ 05919	35881 ~ 35920	40	CAN2 Rx Buffer Message #19
05920 ~ 05959	35921 ~ 35960	40	CAN2 Rx Buffer Message #20
05960 ~ 05999	35961 ~ 36000	40	CAN2 Rx Buffer Message #21

06000 ~ 06039	36001 ~ 36040	40	CAN2 Rx Buffer Message #22
06040 ~ 06079	36041 ~ 36080	40	CAN2 Rx Buffer Message #23
06080 ~ 06119	36081 ~ 36120	40	CAN2 Rx Buffer Message #24
06120 ~ 06159	36121 ~ 36160	40	CAN2 Rx Buffer Message #25
06160 ~ 06199	36161 ~ 36200	40	CAN2 Rx Buffer Message #26
06200 ~ 06239	36201 ~ 36240	40	CAN2 Rx Buffer Message #27
06240 ~ 06279	36241 ~ 36280	40	CAN2 Rx Buffer Message #28
06280 ~ 06319	36281 ~ 36320	40	CAN2 Rx Buffer Message #29

6.2.1.5 Others

“Others” information, including firmware version and rotary switch values of ECAN-240-FD module.

Others			
Protocol Base Address (0xxxx)	PLC Base Address (3xxxx)	Words	Description
08193 ~ 08193	38194 ~ 38194	1	Firmware Version
08194 ~ 08194	38195 ~ 38195	1	Rotary Switch Values of SW2/SW1

6.2.2 Output Data Area

The “Output Data Area” including “CAN Tx FIFO”, “Reboot System”, “Restore default setting” and “Clear CAN status” information for user to use Modbus Function Code 0x10 to set CAN/CAN FD Tx messages and module status of ECAN-240-FD.

Output Data Area of ECAN-240-FD (CAN FD Mode)	
Protocol Base Address (0xxxx)	Description
00000 ~ 00179	CAN1 Tx FIFO Message #1 ~ #5
Reserved	
01024 ~ 01203	CAN2 Tx FIFO Message #1 ~ #5
Reserved	
02049 ~ 02052	Others “System Reboot”, “Restore default setting”, Clear CAN status ... etc

6.2.2.1 CAN FD Tx Message Format

The content of CAN FD Tx message in the Tx FIFO is described in below table. Each CAN FD Tx message will occupy 36 words space of the Modbus address.

CAN Tx Frame Format		
Word No	Description	Note
1, 2	Bit 8~31:Reserved Bit 7: fdf (CAN FD format, 0:CAN or 1: CANFD) Bit 6: brs (Bit Rate Switch, 1:Switch) Bit 5: xtd (CAN Frame Type, 0:STD or 1:EXT) Bit 4: rtr (CAN Frame Type, 0:DATA or 1:REMOTE) Bit 0~3: dlc (Data Length Code) *NOTE1	STD: standard frame (11-bit CAN id) EXT: extended frame (29-bit CAN id)
3, 4	Bit 29~31: Reserved Bit 0~28: id (CAN Frame Identifier)	
5	CAN Data 0, 1 (High Byte: Data0, Low Byte: Data 1)	
6	CAN Data 2, 3	
7	CAN Data 4, 5	
8	CAN Data 6, 7	
9	CAN Data 8, 9	No used for CAN frame
10	CAN Data 10, 11	
11	CAN Data 12, 13	
12	CAN Data 14, 15	
13	CAN Data 16, 17	
14	CAN Data 18, 19	
15	CAN Data 20, 21	
16	CAN Data 22, 23	
17	CAN Data 24, 25	
18	CAN Data 26, 27	
19	CAN Data 28, 29	
20	CAN Data 30, 31	
21	CAN Data 32, 33	
22	CAN Data 34, 35	
23	CAN Data 36, 37	
24	CAN Data 38, 39	
25	CAN Data 40, 41	
26	CAN Data 42, 43	
27	CAN Data 44, 45	
28	CAN Data 46, 47	
29	CAN Data 48, 49	
30	CAN Data 50, 51	
31	CAN Data 52, 53	
32	CAN Data 54, 55	

33	CAN Data 56, 57	
34	CAN Data 58, 59	
35	CAN Data 60, 61	
36	CAN Data 62, 63	

***NOTE1:** dlc (Data Length Code) of CAN FD frame data length

dlc (Hexadecimal)	Frame data length (Decimal)	dlc (Hexadecimal)	Frame data length (Decimal)
0x0	0	0x8	8
0x1	1	0x9	12
0x2	2	0xA	16
0x3	3	0xB	20
0x4	4	0xC	24
0x5	5	0xD	32
0x6	6	0xE	48
0x7	7	0xF	64

6.2.2.2 CAN FD Tx FIFO Address

The CAN1/2 port support CAN FD Tx FIFO. By using Modbus function code 0x10 write command to write the protocol base address of “0” or “1024” and the data length in multiples of 36 words, user can set maximum 5 CAN FD Messages to CAN1/2 Tx FIFO at one time.

CAN1 Tx FIFO Message #1 ~ #5			
Protocol Base Address (0xxxx)	PLC Base Address (4xxxx)	Words	Description
00000 ~ 00179	40001 ~ 40180	36 * 5	CAN1 Tx FIFO Message #1 ~ #5 (N: 1~5) Write “Protocol Base Address: 00000” and “Word No: 36 * N”, you can set N CAN messages to CAN1 Tx FIFO (N: maximum 5 messages).
CAN2 Tx FIFO Message #1 ~ #5			
Protocol Base Address (0xxxx)	PLC Base Address (4xxxx)	Words	Description
01024 ~ 01203	41025 ~ 41204	36 * 5	CAN2 Tx FIFO Message #1~ #5 (N: 1~5) Write “Protocol Base Address: 01024” and “Word No: 36 * N”, you can set N CAN messages to CAN2 Tx FIFO (N: maximum 5 messages).

6.2.2.3 Others

“Others” information, including “Reboot system”, “Restore default setting” and “Clear CAN status” of ECAN-240-FD module.

Others			
Protocol Base Address (0xxxx)	PLC Base Address (4xxxx)	Words	Description
02049 ~ 02049	42050 ~ 42050	1	System Reboot 0x55AA: Reboot system Others: do nothing
02050 ~ 02050	42051 ~ 42051	1	Restore default setting 0x55AA: Restore default Others: do nothing
02051 ~ 02051	42052 ~ 42052	1	Clear CAN1 status 1: clear Others: do nothing
02052 ~ 02052	42053 ~ 42053	1	Clear CAN2 status 1: clear Others: do nothing

7. Ethernet Command Information

When the communication mode of the ECAN-240-FD module is set to [TCP/UDP Transparent](#), TCP/UDP client devices can access the ECAN-240-FD module using the Ethernet commands in CAN/CAN FD format listed in this section. The ECAN-240-FD module then converts these Ethernet commands into CAN/CAN FD format messages and sends them to the CAN network. Similarly, when CAN/CAN FD format messages are received from the CAN network, the ECAN-240-FD converts the messages to Ethernet commands and sends them to the connected TCP/UDP client device.

7.1. Ethernet/CAN Command

When the “Operation Mode” setting is “CAN” mode, the Ethernet command that ECAN-240-FD supports for transmitting and receiving CAN messages are described in the table below.

CAN Port	CAN Message Format	CAN ID	CAN Data
1 byte	1 byte	4 bytes	8 Bytes

The length of each CAN command is fixed at 14 bytes.

Parameters	Size (Byte)	Description
CAN Port	1	CAN Port 1: CAN1 2: CAN2
CAN Message Format	1	CAN Message Format [bit6~7] : Reserved [bit5] : Mode, 0 – Standard frame, 1 – Extended frame [bit4] : RTR, 0 – Data frame, 1 – Remote frame [bit0~3] : DLC ^{*NOTE1} , Data Length Code
CAN ID	4	CAN ID
CAN Data	8	CAN Data

All the parameters are in 8-bit and 32-bit (1 and 4 bytes) format. The data for 32-bit (4 bytes) size is in high-byte first. For example: 0x0A0B0C0D → 0x0A, 0x0B, 0x0C, 0x0D.

***NOTE1:** DLC (Data Length Code) of CAN frame data length

DLC (Hexadecimal)	Frame data length (Decimal)
0x0	0
0x1	1
0x2	2
0x3	3
0x4	4
0x5	5
0x6	6
0x7	7

7.2. Ethernet/CAN FD Command

When the “Operation Mode” setting is “CAN FD” mode, the Ethernet command that ECAN-240-FD supports for transmitting and receiving CAN FD messages are described in the table below and following sections.

Command Header Field			Command Data Field (Max. 18 Data)			
Header	Type	Length	Data-1	Data-2	...	Data-N
1 byte	1 byte	2 bytes	80 Bytes	80 Bytes	...	80 Bytes

7.2.1 Command Header Field

The command header field contains three parameters, header, type and length.

Command Header Field		
Header	Type	Length
1 byte	1 byte	2 bytes

Parameters	Size (Byte)	Description
Header	1	The content of this parameter is fixed to the value of 0x55 .
Type	1	The content of the “Command Data Field” is used for CAN Port 1 or 2. 0x01: The content of the “Command Data Field” is used for CAN Port 1. 0x02: The content of the “Command Data Field” is used for CAN Port 2. Others: Reserved, for future used.
Length	2	Total Length of the “Command Data Field” When the content of “Type” parameter is 0x01 or 0x02, this “Length” parameter is meaning length of “Command Data Field”. Because the length of each data in “Command Data Field” is fixed at 80 Bytes. And a single command can be up to 18 data. So the content of Length must be 80 multiple N (N: 1~18, data number). For Example: <ul style="list-style-type: none"> ● One Data → Length = 80 ● Two Data → Length = 80 x 2 = 160

	<ul style="list-style-type: none">● ...● Eighteen Data → Length = 80 x 18 = 1440 <p>When the content of “Type” parameter is other values: This parameter will be reserved and no used.</p>
--	--

All the parameters are in 8-bit and 16-bit (1 and 2 bytes) format. The data for 16-bit (2 bytes) size is in high-byte first format. For example: 0x0A0B → 0x0A, 0x0B.

7.2.2 Command Data Field

The command data field contains several data (maximum 18 data) which each data size is fixed to 80 bytes. The content of the data is listed in following table.

Command Data Field (Max. 18 Data)			
Data-1	Data-2	...	Data-N
80 Bytes	80 Bytes	...	80 Bytes

Data-N		
Parameters	Size (Byte)	Description
CAN Message ID	4	CAN ID of Standard or Extended CAN/CAN FD Frame. Standard Frame: use 11 bits CAN ID Extended Frame: use 29 bits CAN ID
CAN Message Format	2	Message Format. [bit15:6] : Reserved [bit5] : ESI ^[1] , 0 – Active Error, 1 – Passive Error [bit4] : EVE, 0 – Normal message [bit3] : BRS ^[2] , 0 – bit rate not switch, 1 – bit rate switch [bit2] : XTD, 0 – Standard frame, 1 – Extended frame [bit1] : RTR ^[3] , 0 – Data frame, 1 – Remote frame [bit0] : FDF, 0 – CAN frame, 1 – CAN FD frame
CAN Data Length Code	2	Data Length Code ^[5] of the CAN/CAN FD frame length CAN Frame: 0 ~ 8 → 0 ~ 8 data bytes CAN FD Frame: 0 ~ 8 → 0 ~ 8 data bytes, 0x9 ~ 0xF → 12, 16, 20, 24, 32, 48, 64 data bytes
CAN Data	64 ^[4]	Content of CAN Data. CAN Frame → maximum use 8 bytes data, no used for others CAN FD Frame → maximum use 64 bytes data
Timestamp (sec)	4	Timestamp of received CAN message (unit: second). Reserved and no used for transmitted CAN message

Timestamp (micro-sec)	4	Timestamp of received CAN message (unit: micro second). Reserved and no used for transmitted CAN message
------------------------------	---	---

All the parameters are in 16-bit and 32-bit (2 and 4 bytes) format. The data for 16-bit (2 bytes) size is in high-byte first format. For example: 0x0A0B → 0x0A, 0x0B. And the data for 32-bit (4 bytes) size is in high-byte first. For example: 0x0A0B0C0D → 0x0A, 0x0B, 0x0C, 0x0D.

NOTE:

- [1]: This ESI bit is valid when receiving a CAN FD frame ◦
- [2]: CAN FD frame bit rate switchable. This BRS bit is valid when FDF=1.
- [3]: When FDF=1, the RTR bit cannot set to 1.
- [4]: The size of CAN Data is fixed to 64 bytes. When the “CAN Message format” is a CAN frame, this field will use up to 8 bytes of data. When it is a CAN FD frame, this field will use up to 64 bytes of data.
- [5]: Mapping table of Data Length Code to Frame data length

Data Length Code (Hexadecimal)	Frame data length (Decimal)	Data Length Code (Hexadecimal)	Frame data length (Decimal)
0x0	0	0x8	8
0x1	1	0x9	12
0x2	2	0xA	16
0x3	3	0xB	20
0x4	4	0xC	24
0x5	5	0xD	32
0x6	6	0xE	48
0x7	7	0xF	64

7.2.3 Ethernet command Examples

- ◆ **Example 1:** Transmit a CAN message from CAN1 of ECAN-240-FD which frame format is listed below
 - Standard CAN frame which CAN ID is 0x123
 - CAN Data length is 4 with data 0x11, 0x22, 0x33, 0x44

Transmitted Ethernet command will like below table.

Command	Data Content (Hexadecimal)	Note
Command Header Field		
Header	0x55	
Type	0x01	CAN1
Data Length	0x00 0x50	80
Command Data Field - Data1		
CAN Message ID	0x00 0x00 0x01 0x23	
CAN Message Format	0x00 0x00	
CAN Data Length Code	0x00 0x04	
CAN Data	0x11 0x22 0x33 0x44 0x00	4 bytes data valid
Timestamp (sec)	0x00 0x00 0x00 0x00	Reserved
Timestamp (micro-sec)	0x00 0x00 0x00 0x00	Reserved

- ◆ **Example 2:** Transmit one CAN message and one CAN FD message from CAN2 of ECAN-240-FD by using one command which frame format is listed below

CAN message #1

- Extended CAN frame which CAN ID is 0x12345678
- CAN Data length is 2 with data 0x11, 0x22

CAN message #2

- Standard CAN FD frame which CAN ID is 0x123
- CAN Data length is 16 with data 0x01, 0x02, 0x03, 0x04, 0x05, 0x06, 0x07, 0x08, 0x09, 0x0A, 0x0B, 0x0C, 0x0D, 0x0E, 0x0F, 0x10
- Transmit this CAN FD message with bit rate switch enable

Transmitted Ethernet command will like below table.

Command	Data Content (Hexadecimal)	Note
Command Header Field		
Header	0x55	
Type	0x02	CAN2
Data Length	0x00 0xA0	160
Command Data Field - Data1		
CAN Message ID	0x12 0x34 0x56 0x78	
CAN Message Format	0x00 0x04	
CAN Data Length Code	0x00 0x02	
CAN Data	0x11 0x22 0x00	2 bytes data valid
Timestamp (sec)	0x00 0x00 0x00 0x00	Reserved
Timestamp (micro-sec)	0x00 0x00 0x00 0x00	Reserved
Command Data Field - Data2		

CAN Message ID	0x00 0x00 0x01 0x23	
CAN Message Format	0x00 0x09	
CAN Data Length Code	0x00 0x0A	
CAN Data	0x01 0x02 0x03 0x04 0x05 0x06 0x07 0x08 0x09 0x0A 0x0B 0x0C 0x0D 0x0E 0x0F 0x10 0x00	16 bytes data valid
Timestamp (sec)	0x00 0x00 0x00 0x00	Reserved
Timestamp (micro-sec)	0x00 0x00 0x00 0x00	Reserved

- ◆ **Example 3:** Receive a CAN FD message from CAN1 of ECAN-240-FD at 10s.000us which frame format is listed below
 - Extended CAN FD frame which CAN ID is 0x12345678
 - CAN Data length is 8 with data 0x11, 0x22, 0x33, 0x44, 0x55, 0x66, 0x77 0x88
 - CAN FD bit rate switch is enabled

Received Ethernet command will like below table.

Command	Data Content (Hexadecimal)	Note
Command Header Field		
Header	0x55	
Type	0x01	CAN1
Data Length	0x00 0x50	80
Command Data Field - Data1		
CAN Message ID	0x12 0x34 0x56 0x78	
CAN Message Format	0x00 0x0D	
CAN Data Length Code	0x00 0x08	
CAN Data	0x11 0x22 0x33 0x44 0x55 0x66 0x77 0x88 0x00	8 bytes data valid
Timestamp (sec)	0x00 0x00 0x00 0x0A	10 s
Timestamp (micro-sec)	0x00 0x00 0x00 0x00	000 us

- ◆ **Example 4:** Receive two CAN FD messages from CAN2 of ECAN-240-FD at 10s.000us and 10s.1000us which frame format is listed below

CAN message #1

- Standard CAN FD frame which CAN ID is 0x123
- CAN Data length is 4 with data 0x01, 0x02, 0x03, 0x04
- CAN FD bit rate switch is enabled

CAN message #2

- Extended CAN FD frame which CAN ID is 0x12345678
- CAN Data length is 12 with data 0x01, 0x02, 0x03, 0x04, 0x05, 0x06, 0x07, 0x08, 0x09, 0x0A, 0x0B, 0x0C
- CAN FD bit rate switch is enabled

Received Ethernet command will like below table.

Command	Data Content (Hexadecimal)	Note
Command Header Field		
Header	0x55	
Type	0x02	CAN2
Data Length	0x00 0xA0	160
Command Data Field - Data1		
CAN Message ID	0x00 0x00 0x01 0x23	
CAN Message Format	0x00 0x09	
CAN Data Length Code	0x00 0x04	
CAN Data	0x01 0x02 0x03 0x04 0x00	4 bytes data valid
Timestamp (sec)	0x00 0x00 0x00 0x0A	10 s
Timestamp (micro-sec)	0x00 0x00 0x00 0x00	000 us

Command Data Field - Data2		
CAN Message ID	0x12 0x34 0x56 0x78	
CAN Message Format	0x00 0x0D	
CAN Data Length Code	0x00 0x09	
CAN Data	0x01 0x02 0x03 0x04 0x05 0x06 0x07 0x08 0x09 0x0A 0x0B 0x0C 0x00	12 bytes data valid
Timestamp (sec)	0x00 0x00 0x00 0x0A	10 s
Timestamp (micro-sec)	0x00 0x00 0x03 0xE8	1000 us

8. Typical Applications

This chapter provides some examples of typical scenarios for the ECAN-240-FD module, including applications focused on the Modbus TCP Server, TCP/UDP Transparent and CAN Pair Connection etc...

8.1. Modbus TCP Server Application

The Modbus TCP server function is used to enable communication between CAN devices and Modbus TCP clients. When the ECAN-240-FD module is acting as a Modbus TCP server, Modbus TCP clients need to use Modbus commands based on CAN format in order to access the ECAN-240-FD module. The ECAN-240-FD module then converts these commands into CAN format messages and sends them to the CAN network. Similarly, when receiving CAN formatted messages from the CAN network, the ECAN-240-FD converts the messages to Modbus format and then uses Modbus commands to access the messages.

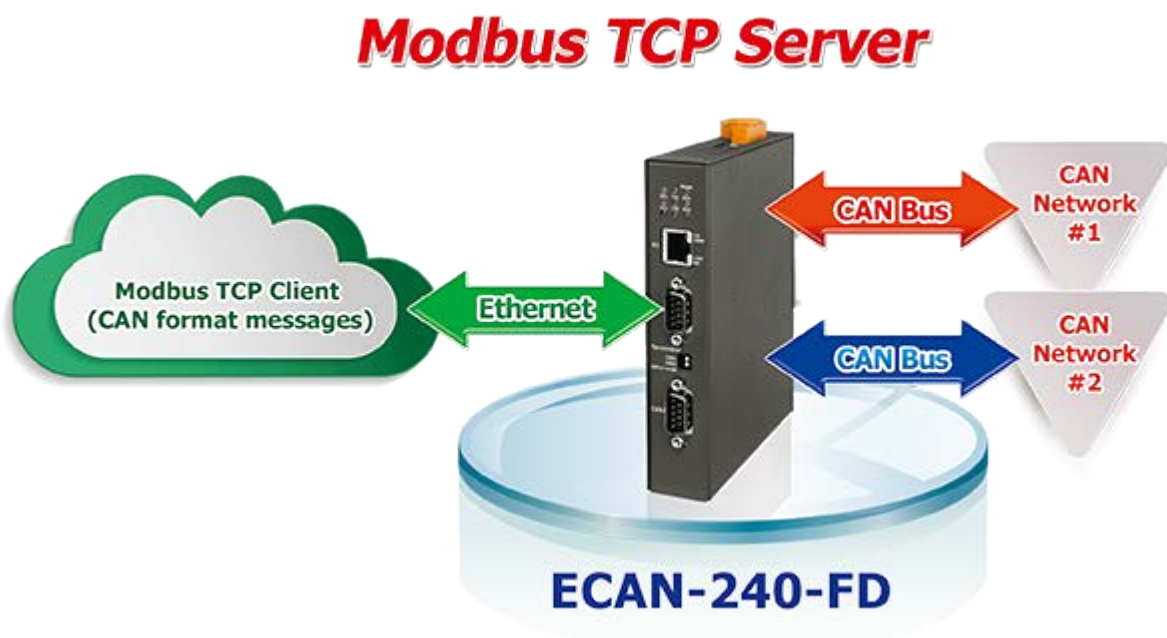

8.2. TCP/UDP Transparent Application

The TCP/UDP transparent function is used to implement communications between CAN devices and a TCP/UDP Client device. When the communication mode of ECAN-240-FD module is set to TCP/UDP Transparent, the TCP/UDP Client device can use Ethernet commands base on the CAN/CAN FD format, listed in section 7, in order to access the ECAN-240-FD module. Then ECAN-240-FD module will translate these Ethernet commands into CAN/CAN FD format messages and send them to the CAN networks. Similarly, when a CAN/CAN FD format message is received from the CAN network, the ECAN-240-FD will translates the message into Ethernet commands and sent it to the connected TCP/UDP client device.

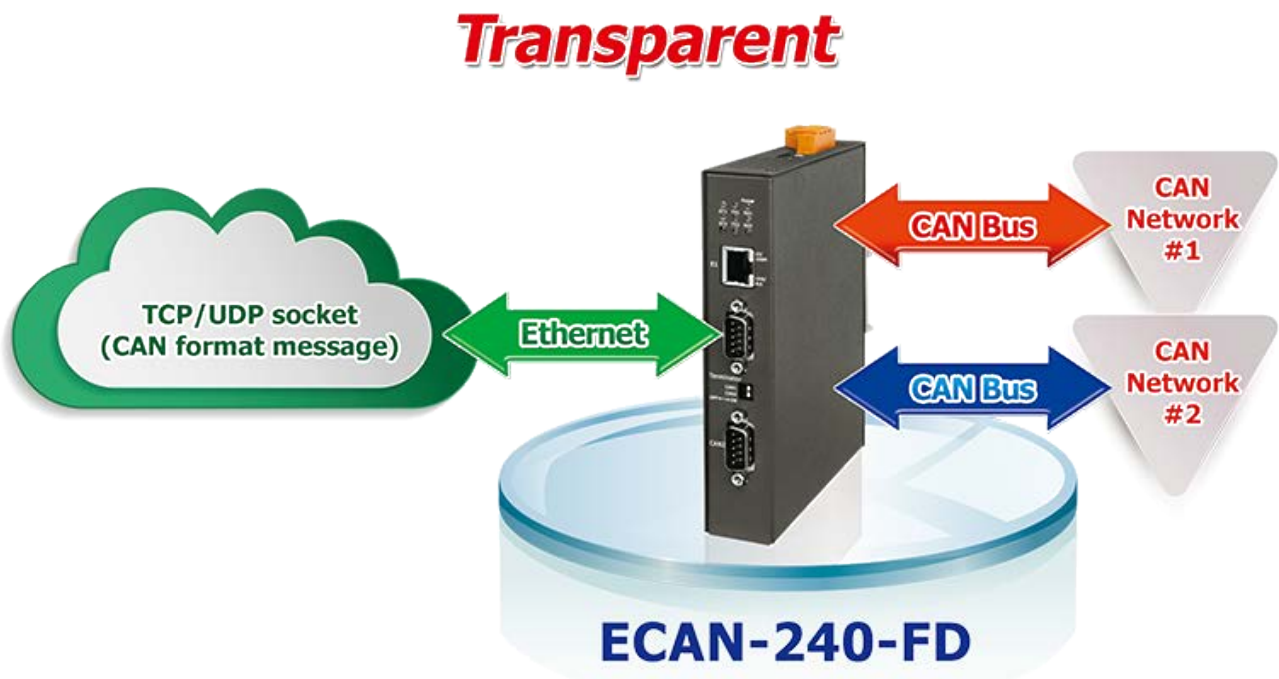

8.3. CAN Pair Connection Application

The CAN pair connection application of the ECAN-240-FD module is used to implement communication between two ends of CAN network via Ethernet. It is implemented via UDP protocol for CAN Network #1 can communicate with CAN Network #3 and CAN Network #2 can also communicate with CAN Network #4 in the same manner.



CAN Network #1 ↔ CAN Network #3 CAN Network #2 ↔ CAN Network #4		
Parameters	ECAN-240-FD #1	ECAN-240-FD #2
IP Address	192.168.255.1	192.168.255.2
Operation Mode	CAN FD	CAN FD
Communication Mode	UDP Transparent	UDP Transparent
Local command Port	10003	10003
Remote Device IP	192.168.255.2	192.168.255.1
Remote Device Port	10003	10003

Appendix A. Troubleshooting

A.1. How do I restore the web password for the module to the factory default password?

The instructions below outline the procedure for resetting the web password to the factory default value.

Note:

*Be aware that **ALL** settings will be restored to the factory default values after the module is reset.*

Step 1

Locate the SW1/SW2 switch that can be found on the top side of the ECAN-240-FD module and set SW2 to “F” and SW1 to “E” position. Reboot the module to **load factory default settings** including default web password.

Step 2

Execute either the eSearch Utility to search for any ECAN-240-FD modules connected to the network. Verify that the ECAN-240-FD has been reset to the original factory default settings. For example, the module should be shown as having the default IP address, which is 192.168.255.1.

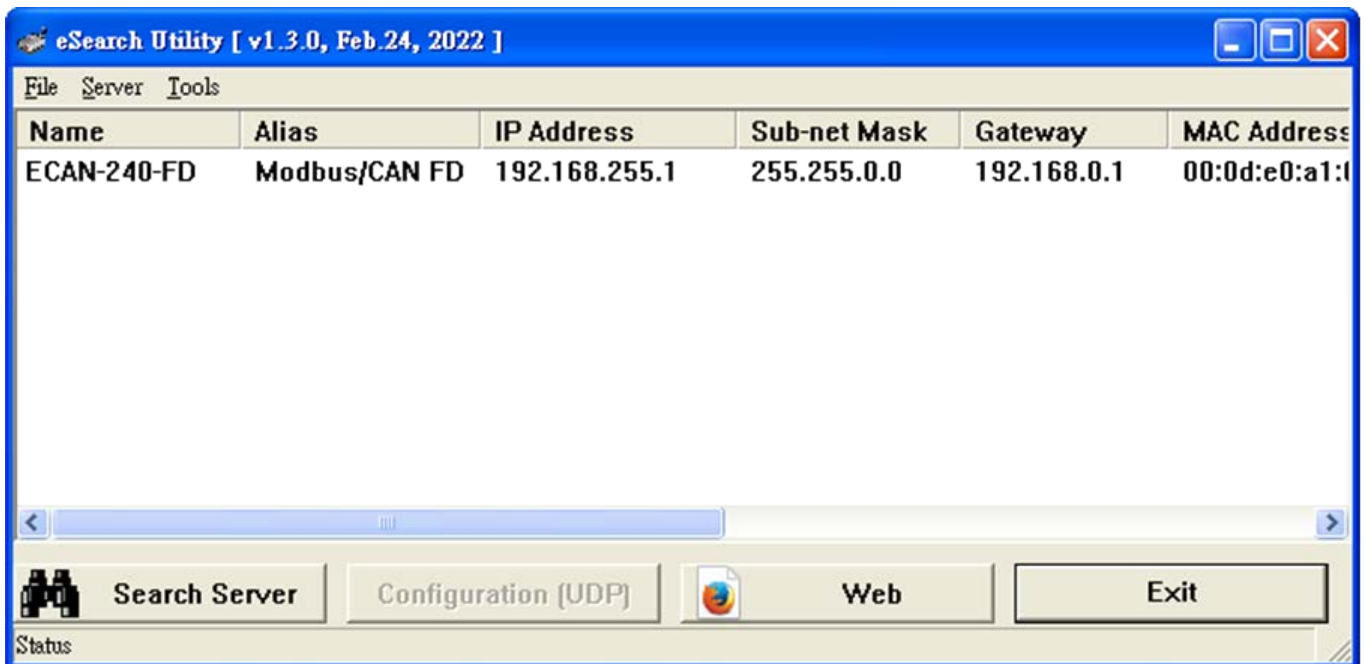

Step 3

Double-click the name of the module to open the Configure Server (UDP) dialog box, and modify the basic settings as necessary, e.g., the IP, Mask and Gateway addresses, and then click the “OK” button to **save the new settings**.

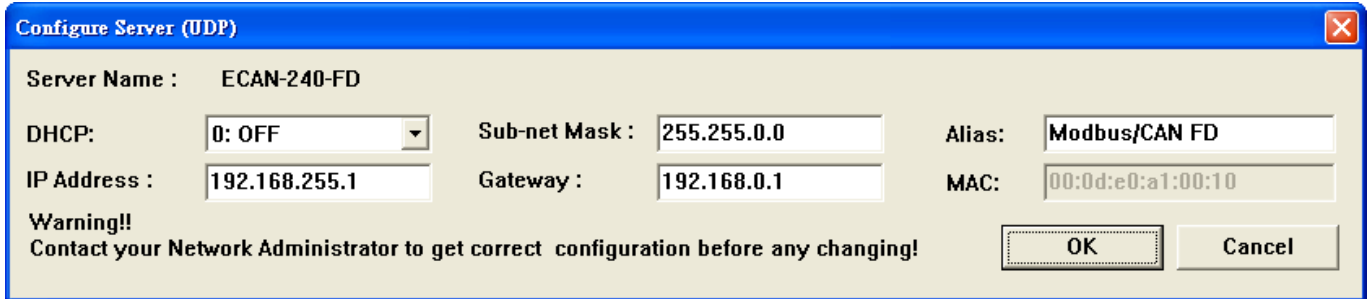

Step 4

Reset the SW1/SW2 switch on the ECAN-240-FD module to SW2 to “0” and SW1 to “0” position and reboot the device.

Step 5

Log in to the web configuration pages for the ECAN-240-FD module, using the default web password, “admin”.

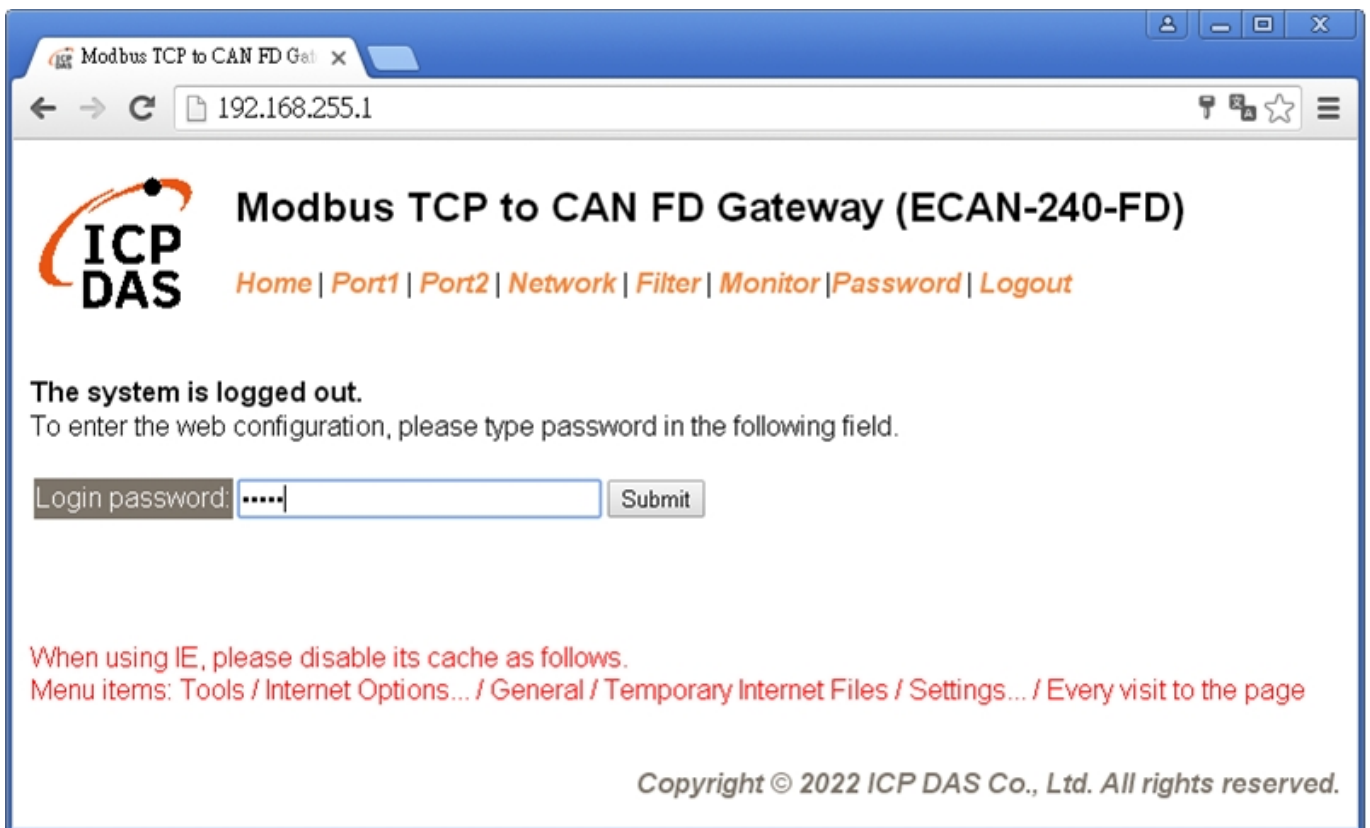

Appendix B. Glossary

1. ARP (Address Resolution Protocol)

The Address Resolution Protocol (ARP) is a telecommunication protocol that is used to convert an IP address to a physical address, such as an Ethernet address.

Consider two machines A and B that share the same physical network. Each has an assigned IP address IP_A and IP_B , and a MAC address, MAC_A and MAC_B . The goal is to devise a low-level software application that hides the MAC addresses and allows higher-level programs to work only with the IP addresses. Ultimately, however, communication must be carried out by the physical networks using whatever MAC address scheme the hardware supplies.

Suppose machine A wants to send a packet to machine B across a physical network to which they are both attached, but A only has the Internet address for B, IP_B . The question arises: how does A map that address to the MAC address for B, MAC_B ?

ARP provides a method of dynamically mapping 32-bit IP address to the corresponding 48-bit MAC address. The term dynamic is used since the mapping is performed automatically and is normally not a concern for either the application user or the system administrator.

2. RARP (Reverse Address Resolution Protocol)

RARP provides a method of dynamically mapping 48-bit MAC address to the corresponding 32-bit IP address. RARP has now been replaced by the Bootstrap Protocol (BOOTP) and the modern Dynamic Host Configuration Protocol (DHCP).

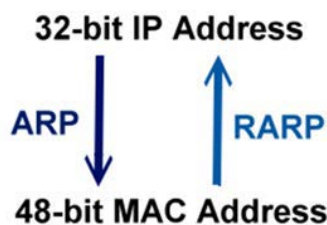

3. Clients and Servers

The client-server paradigm uses the direction of initiation to categorize whether a program is a client or server. In general, an application that initiates peer-to-peer communication is called a client. End users usually invoke client programs when they use network services.

By comparison, a server is any program that waits for incoming requests from a client program. The server receives a request from a client, performs the necessary action and returns the result to the client.

4. Ethernet

The term Ethernet generally refers to a standard published in 1982 by Digital Equipment Corp., Intel Corp. and Xerox Corp. Ethernet is the most popular physical layer Local Area Network (LAN) technology in use today.

5. Firmware

Firmware is an embedded software program or set of instructions programmed on a device that provides the necessary instructions for how the device communicated with other computer hardware, and is located or stored in a semi-permanent storage area, e.g., ROM, EEPROM, or Flash memory. Firmware can often be updated by downloading a file from the manufacturer's web site or FTP.

6. ICMP (Internet Control Message Protocol)

ICMP provides a method of communicating between the Internet Protocol software on one machine and the corresponding software on another. It allows a gateway to send error or control messages to other gateways, or allows a host to diagnose problems with the network communication.

7. Internet

Physically, the Internet is a collection of packet switching networks interconnected by gateways that together with the TCP/IP protocol, allows them to perform logically as a single, large and virtual network. The Internet recognizes hosts using 32-bit IP address.

8. IP (Internet Protocol) Address

Each interface on the Internet must have a unique IP address (also called an Internet address). These addresses are 32-bit numbers, and are normally written as four decimal numbers, one for each byte of the address for example “192.168.41.1”. This is called dotted-decimal notation.

9. Subnet Mask

A Subnet mask, often simply called the “Mask”, is a 32-bit number that masks and IP address, and divides the IP address into the network address and the host address. Given its own IP address and its subnet mask, a host can determine whether a TCP/IP packet is destined for a host that is (1) on its own subnet, or (2) on a different network. If (1), the packet will be delivered directly; otherwise it, will be delivered via a gateway or a router.

10. Gateway

Computers that interconnect two networks and pass packets from one to the other are called Internet Gateways or Internet Routers. Gateways route packets that are based on the destination network, rather than the destination host.

11. MAC (Media Access Control) Address

To allow a computer to determine which packets are meant for it, each device attached to an Ethernet network is assigned a 48-bit integer known as its MAC address (also called the Ethernet address, the hardware address or the physical address). A MAC address is normally written as six hexadecimal numbers, for example “00:0D:E0:20:00:01”. Ethernet hardware manufacturers purchase blocks of MAC addresses and assign them in sequence as they manufacture Ethernet interface hardware. Thus, no two hardware interfaces can have the same MAC address.

12. Packet

A packet is the unit of data sent across a physical network. It consists of a series of bits containing data and control information, including the source and the destination node (host) address, and is formatted for transmission from one node to another.

13. Ping

Ping is a network administration utility used to test the whether a host on an Internet network is active, and to measure the round-trip time for messages sent from the originating host to a destination computer. Ping operates by sending an ICMP echo request message to a host, expecting an ICMP echo reply to be returned. Normally, if a host cannot be pinged, Telnet or FTP cannot be used to connect to the host. Conversely, if Telnet or FTP cannot be used to connect to a host, Ping is often the starting point to determine the nature of the problem.

14. Socket

Each TCP segment contains a source and destination port number that can be used to identify the sending and receiving application. These two values, along with the source and destination IP addresses in the IP header, uniquely identify each connection. The combination of an IP address and a port number is called a socket.

15. TCP (Transmission Control Protocol)

TCP is a set of rules used in combination with the Internet Protocol to send data in the form of message units between computers over the Internet. TCP provides a reliable flow of data between two hosts and is associated with tasks such as dividing the data passed to it from an application into appropriately sized chunks for the network layer below, acknowledging received packets, setting timeouts to make certain that the other end acknowledges packets that are sent, and so on.

16. TCP/IP

The Transmission Control Protocol (TCP) and the Internet Protocol (IP) is standard network protocols that are almost always implemented and used together in a formation are known as TCP/IP. TCP/IP can be used to communicate across any set of interconnected networks.

17. UDP (User Datagram Protocol)

UDP is an internet protocol that provides a much simpler service to the application layer as it only sends packets of data from one host to another, but there is no guarantee that the packets will reach the destination host. UDP is suitable for purposes where error checking and correction is either not necessary or is performed in the application.

Appendix C. Valid Data Phase Bit Rate of CAN FD

Items	Supported Data Phase Bit Rate (kbps)				
	0	1	2	3	4
0	10000.000	8571.429	7500.000	6666.667	6000.000
5	5454.545	5000.000	4615.385	4285.714	4000.000
10	3750.000	3529.412	3333.333	3157.895	3000.000
15	2857.143	2727.273	2608.696	2500.000	2400.000
20	2307.692	2222.222	2142.857	2068.966	2000.000
25	1935.484	1875.000	1818.182	1764.706	1714.286
30	1666.667	1621.622	1578.947	1538.462	1500.000
35	1463.415	1428.571	1395.349	1363.636	1333.333
40	1304.348	1276.596	1250.000	1224.49	1200.000
45	1176.471	1153.846	1132.075	1111.111	1090.909
50	1071.429	1052.632	1034.483	1016.949	1000.000
55	983.6066	967.7419	952.381	937.500	923.0769
60	909.0909	895.5224	882.3529	869.5652	857.1429
65	845.0704	833.3333	821.9178	810.8108	800.000
70	789.4737	779.2208	769.2308	759.4937	750.000
75	740.7407	731.7073	722.8916	714.2857	705.8824
80	697.6744	689.6552	681.8182	674.1573	666.6667
85	659.3407	652.1739	645.1613	638.2979	631.5789
90	625.000	618.5567	612.2449	606.0606	600.000
95	594.0594	588.2353	582.5243	576.9231	571.4286
100	566.0377	560.7477	555.5556	550.4587	545.4545
105	540.5405	535.7143	530.9735	526.3158	521.7391
110	517.2414	512.8205	508.4746	504.2017	500.000
115	495.8678	491.8033	487.8049	483.871	480.000
120	476.1905	472.4409	468.750	465.1163	461.5385
125	458.0153	454.5455	451.1278	447.7612	444.4444
130	441.1765	437.9562	434.7826	431.6547	428.5714
135	425.5319	422.5352	419.5804	416.6667	413.7931

140	410.9589	408.1633	405.4054	402.6846	400.000
145	397.351	394.7368	392.1569	389.6104	387.0968
150	384.6154	382.1656	379.7468	377.3585	375.000
155	372.6708	370.3704	368.0982	365.8537	363.6364
160	361.4458	359.2814	357.1429	355.0296	352.9412
165	350.8772	348.8372	346.8208	344.8276	342.8571
170	340.9091	338.9831	337.0787	335.1955	333.3333
175	331.4917	329.6703	327.8689	326.087	324.3243
180	322.5806	320.8556	319.1489	317.4603	315.7895
185	314.1361	312.500	310.8808	309.2784	307.6923
190	306.1224	304.5685	303.0303	301.5075	300.000
195	298.5075	297.0297	295.5665	294.1176	292.6829
200	291.2621	289.8551	288.4615	287.0813	285.7143
205	284.3602	283.0189	281.6901	280.3738	279.0698
210	277.7778	276.4977	275.2294	273.9726	272.7273
215	271.4932	270.2703	269.0583	267.8571	266.6667
220	265.4867	264.3172	263.1579	262.0087	260.8696
225	259.7403	258.6207	257.5107	256.4103	255.3191
230	254.2373	253.1646	252.1008	251.046	250.000
235	248.9627	247.9339	246.9136	245.9016	244.898
240	243.9024	242.915	241.9355	240.9639	240.000
245 ~ 290	...				
290	202.7027	202.0202	201.3423	200.6689	200.000
295 ~ 365	...				
365	161.7251	161.2903	160.8579	160.4278	160.000
370~390	...				
390	151.5152	151.1335	150.7538	150.3759	150.000
395~470	...				
470	126.0504	125.7862	125.523	125.261	125.000
475 ~ 490	...				
490	120.9677	120.7243	120.4819	120.2405	120.000
495 ~ 590	...				
590	100.6711	100.5025	100.3344	100.1669	100.000

Appendix D. Revision History

This chapter provides revision history information to this document.

The table below shows the revision history.

Revision	Date	Description
2.0.0	Aug. 2023	Initial issue