I-7565-H1 / I-7565-H2

High Performance USB/CAN Converter

User's Manual

Warranty

All products manufactured by ICP DAS are under warranty regarding defective materials for a period of one year from the date of delivery to the original purchaser.

Warning

ICP DAS assumes no liability for damages resulting from the use of this product. ICP DAS reserves the right to change this manual at any time without notice. The information furnished by ICP DAS is believed to be accurate and reliable. However, no responsibility is assumed by ICP DAS for its use, or for any infringements of patents or other rights of third parties resulting from its use.

Copyright

Copyright 2009 by ICP DAS. All rights are reserved.

Trademark

The names used for identification only may be registered trademarks of their respective companies.

Table of Contents

1. Introduction	5
1.1 Features	6
1.2 Specifications	6
2. Hardware	8
2.1 Block Diagram	8
2.2 Pin Assignment of CAN Port	9
2.3 Hardware Connection	9
2.4 Terminator Resistor Settings	11
2.5 Init / Normal Dip-switch	12
2.5.1 Firmware Update Mode	12
2.5.2 Firmware Operation Mode	13
2.6 LED Indication	15
2.7 Cable Selection	16
3. Driver Installation	18
3.1 Install I-7565-H1/H2 Driver by Auto	18
3.2 Install I-7565-H1/H2 Driver by Manual	19
3.3 Verify Driver Installation	22
3.4 Uninstall I-7565-H1/H2 Driver	23
4. Software Utility	24
4.1 INI File Function	24
4.2 Connection Function	24
4.3 Communication Function	27
4.4 Config Function	33
4.4.1 Module Config Function	33
4.4.2 Advanced Config Function	37
4.4.3 Extra Config Function	41
4.5 Data Log Function	42
4.6 Status Bar Function	45
5. API Library -- VCI_CAN.dll	46
5.1 API Library Overview	46
5.2 API Library Function Table	47
5.3 Flow Chart for Users' Program Development by Using API	49
5.4 Init Function	50
5.4.1 VCI_OpenCAN	50
5.4.2 VCI_CloseCAN	52
5.5 Module Config Function	53

5.5.1	VCI_Set_CANFID	53
5.5.2	VCI_Get_CANFID	55
5.5.3	VCI_Get_CANStatus	57
5.5.4	VCI_Clr_BufOverflowLED	59
5.5.5	VCI_Get_MODInfo	60
5.5.6	VCI_Rst_MOD	61
5.5.7	VCI_Set_MOD_Ex	62
5.6	Communication Function	63
5.6.1	VCI_SendCANMsg	63
5.6.2	VCI_RecvCANMsg.....	65
5.6.3	VCI_EnableHWCyclicTxMsg.....	67
5.6.4	VCI_DisableHWCyclicTxMsg	69
5.6.5	VCI_EnableHWCyclicTxMsgNo	70
5.6.6	VCI_EnableHWCyclicTxMsgNo_Ex	72
5.6.7	VCI_DisableHWCyclicTxMsgNo	74
5.7	Software Buffer Function.....	75
5.7.1	VCI_Get_RxMsgCnt.....	75
5.7.2	VCI_Get_RxMsgBufIsFull	76
5.7.3	VCI_Clr_RxMsgBuf	77
5.7.4	VCI_Get_TxMsgCnt	78
5.7.5	VCI_Clr_TxMsgBuf	79
5.7.6	VCI_Get_TxSentCnt	80
5.7.7	VCI_Clr_TxSentCnt.....	81
5.8	User Defined ISR Function	82
5.8.1	VCI_Set_UserDefISR.....	82
5.8.2	VCI_Clr_UserDefISR.....	84
5.8.3	VCI_Get_ISRCANData	85
5.9	Other Function	86
5.9.1	VCI_Get_DIIVer.....	86
5.9.2	VCI_DoEvents.....	87
5.10	Extended Function	88
5.10.1	VCI_OpenCAN_Ex.....	88
5.10.2	VCI_Get_CANBaud_BitTime.....	90
5.11	Return Code.....	91
6.	API Library -- mVCI_CAN.dll.....	92
6.1	For VC Project	92
6.2	For VB Project.....	93
6.3	For .Net Project.....	95

7. Troubleshooting	96
7.1 The Connection Issue	96
Q1 : "Invalid port number" error message ?.....	96
Q2 : "The device is not open" error message ?	97
Q3 : "Device doesn't Exist" error message ?	98
Q4 : "Could not set comm state" error message ?.....	98
7.2 The CAN Baud Rate Issue.....	99
7.3 The Same CAN-ID Conflict Issue.....	101
7.4 The PC Rebooting Issue	101
7.5 The Max Data Transfer Rate (fps) Issue	101
7.6 The Data Loss Issue	101
7.7 The Module Number Applied to One PC Issue	102
7.8 The Long Driver Installation Time Issue	102
7.9 The Supported CAN Filter-ID Number Issue.....	103
7.10 Other Issue	104
7.11 Windows 7 Issues	104
7.12 I-7565-H1/H2 can't receive CAN message	106
7.13 I-7565-H1/H2 provides LabVIEW Driver	107
7.14 How to adjust the Bit-Timing parameters of I-7565-H1/H2 ?.....	107
7.15 How to enable "CAN Error Frame" function of I-7565-H1/H2 ?.....	108
7.16 New function - "OverWrite" supported in Utility v1.09 ?.....	109
7.17 New function - "Symbolic" supported in Utility v1.10 ?	109
7.18 How to send the CAN messages precisely ?	110
7.19 Listen CAN messages without affecting CAN Comm. ?.....	110
7.20 How to get the current CAN bus data flow ?	112
7.21 How to make I-7565-H1/H2 become a CAN data logger ?.....	113
7.22 How to receive the assigned CAN-ID data immediately ?.....	114
7.23 Does API of I-7565-H1/H2 support Visual Studio Express ?	115
7.24 When DotNet demo runs in Win7_x64 OS, it will show the "0x8007000B" or "System.NullReferenceException" error ?	115
7.25 Windows 10 Issues	115
7.26 When setting CAN Filter-ID by using VCI_Set_CANFID failed, It may cause module connection failed ?	121
7.27 How to use Excel to open CAN received record file ?.....	122
8. Linux User Manual	124
9. History of Version	125

1. Introduction

I-7565-H1 and I-7565-H2 are the high performance intelligent USB to CAN converters with one and two CAN channels separately. They provide faster CAN bus communication performance than I-7565. Both I-7565-H1 and I-7565-H2 support CAN2.0A/2.0B protocol and different baud rates from 5 Kbps to 1 Mbps. The important feature of I-7565-H1/H2 is to support the user-defined baud rate function no matter what the baud rate is. When connecting I-7565-H1/H2 to PC, PC will load the relevant device driver automatically (hot plug & play). Therefore, users can make data collection and processing of CAN bus network easier and quicker by applying I-7565-H1/H2. The application fields can be CAN bus monitoring, building automation, remote data acquisition, environment control and monitoring, laboratory equipment & research, factory automation, etc.

The following is the application for these two USB/CAN modules :

- (1) **I-7565-H1:** High performance intelligent USB to 1- port CAN bus Converter.
- (2) **I-7565-H2:** High performance intelligent USB to 2- port CAN bus Converter.



Figure 1-1: Application of I-7565-H1/H2



1.1 Features

- RoHS Design
- Fully compliant with USB 1.1/2.0 (Full Speed)
- Fully compatible with the ISO 11898-2 standard
- Support both CAN2.0A and CAN2.0B
- No external power supply (powered by USB)
- Integrated with one or two CAN bus interface
- Programmable CAN bus baud rate from 5Kbps to 1Mbps or user-defined baud rate
- Support CAN bus acceptance filter configuration
- Support Listen Only Mode (LOM). (For FW v1.05 or newer)
- Support 5 sets of Hardware Send Timer for high precision CAN messages sending. (For FW v1.05 or newer)
- Support CAN Error Frame Information. (For FW v1.07 or newer)
- Support adjustable Bit-Timing of CAN Baud (Tseg2). (For FW v1.07 or newer)
- Timestamp of CAN message with at least ± 1 ms precision
- Support firmware update via USB
- Provide utility tool for users module setting and CAN bus communication testing conveniently
- Provide API library for user program development
- Provide Hardware Serial Number to protect users' program. (For FW v1.04 or newer)
- Provide PWR / RUN / ERR indication LED
- Built-in jumper to select 120 ohm terminal resistor
- Max data flow for CAN channel: 3000 fps (depends on users' PC hardware performance)
- The CAN buffer is 256 data frames for I-7565-H1 and 128 data frames in each CAN port for I-7565-H2.
- Watchdog inside
- Driver supported for Windows 2000/XP, Win7(32/64bit) and WinCE (available soon)

1.2 Specifications

[USB specs:]

- Input port : USB (USB Type B)
- Compatibility : USB 1.1 and 2.0 standard
- Driver Supported : Windows 2000/XP, Win7(32/64bit) and WinCE

(available soon)

[CAN specs:]

- CAN interface connector:
 - I-7565-H1 : 9-pin D-sub male
 - I-7565-H2 : 10-pin terminal-block
- CAN Baud Rate : 5K ~ 1Mbps or User-defined baud rate
- Isolation Voltage : 3000Vrms on the CAN side

[Module specs:]

- Dimensions : 108mm x 72mm x 35mm (H x W x D)
- Operating temperature : -25 to 75°C (-13 to 167°F);
- Storage temperature : -40 to 80°C (-40 to 176°F);
- Humidity : 5 to 95%, non-condensing;
- LEDs : PWR LED for power
RUN LED for communication
ERR LED for error

[Software Utility Tool / API Library:]

- Provide CAN bus user-defined baud rate / acceptance filter configuration
- Easily transmit / receive CAN messages for testing and display the time-stamp of each received CAN message.
- Provide saving the CAN message as “TXT” file for data log.
- Provide sending CAN message by using the internal timer of module for high precision transmission.
- Check / Reset module status remotely and get current CAN bus message flow.
- Users can develop own program by API library quickly and easily.

[Application:]

- Factory Automation;
- Building Automation;
- Home Automation;
- Control system;
- Monitor system;
- Vehicle Automation;

2. Hardware

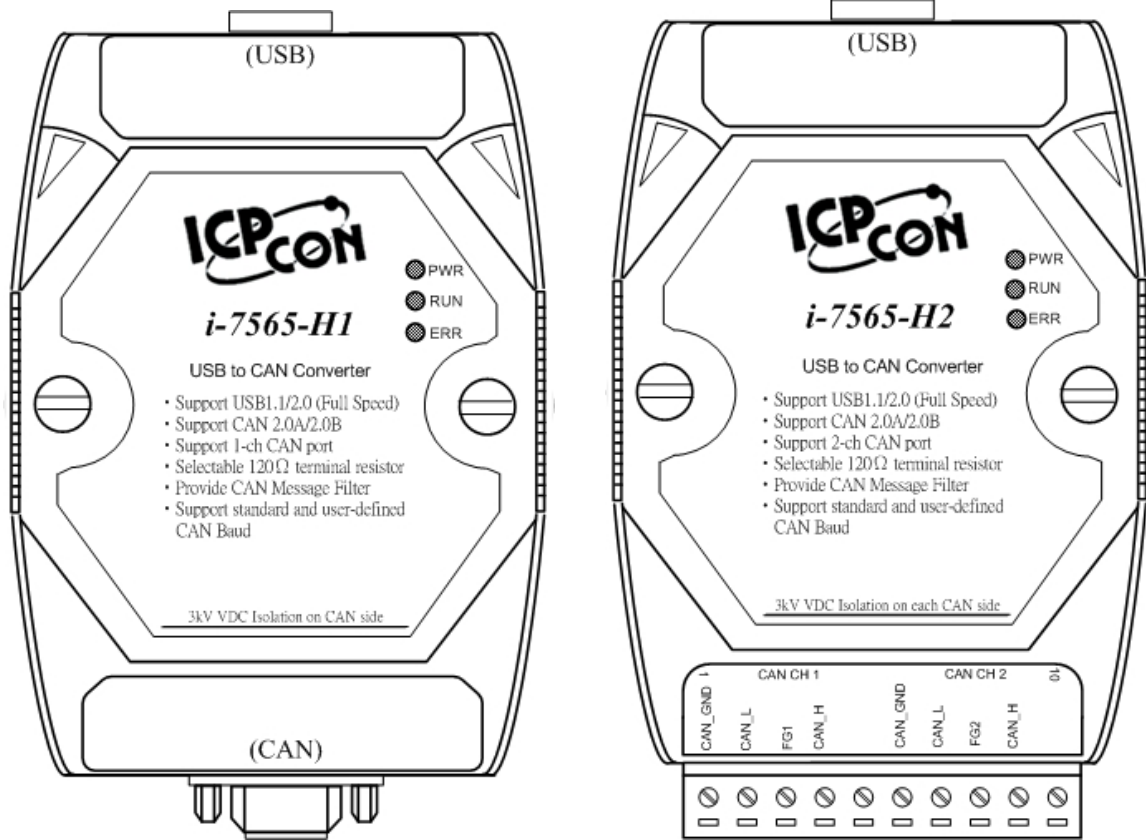

Figure 2-1: Hardware externals of I-7565-H1/H2

2.1 Block Diagram

Figure 2-2 is a block diagram illustrating the functions on the I-7565-H1/H2 module. It provides the 3000Vrms Isolation in the CAN interface site.

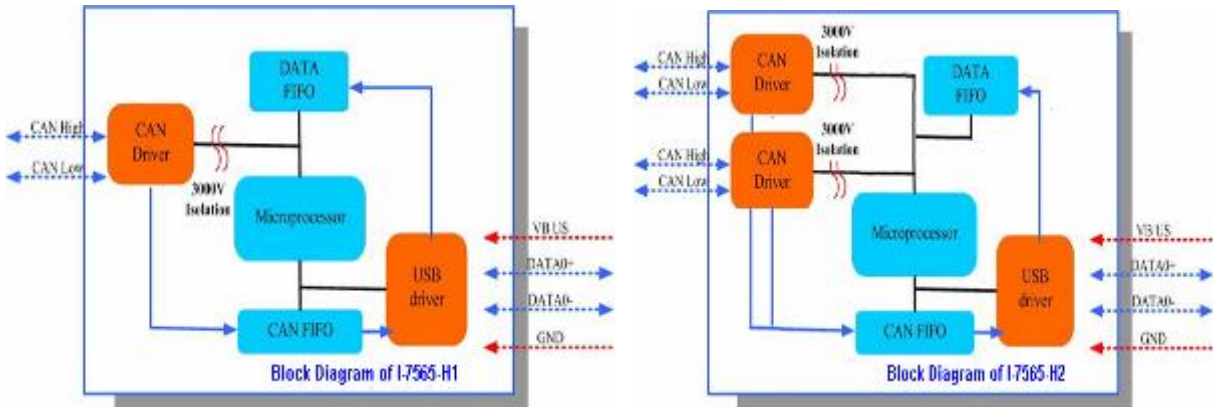

Figure 2-2: Block diagram of I-7565-H1 / I-7565-H2

2.2 Pin Assignment of CAN Port

Table 1: CAN DB9 Male Connector on I-7565-H1

Terminal	2-wire CAN
1	Not Connect
2	CAN Low
3	CAN Ground
4	Not Connect
5	
6	CAN Ground
7	CAN High
8	Not Connect
9	

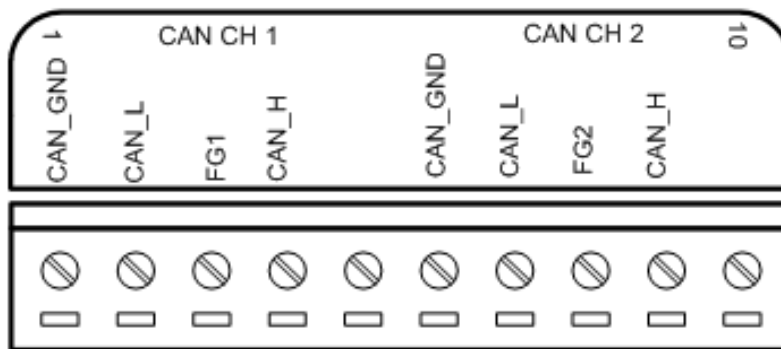
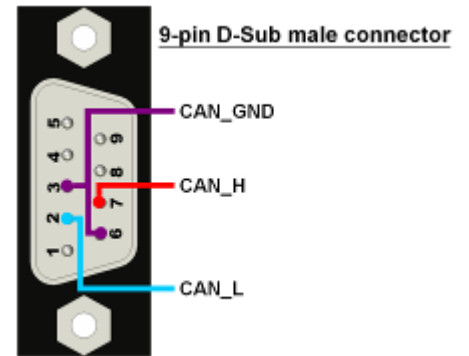

Figure 2-3: Pin Assignment on I-7565-H2

2.3 Hardware Connection

The pin assignment of the CAN port on the I-7565-H1 (DB9 male) defined in both the CANopen DS102 profile and in appendix C of the DeviceNet specifications. It is the standard pin assignment for CAN. The hardware connection between device and I-7565-H1/H2 is like Figure 2-4.

CAN Devices Wire Connection

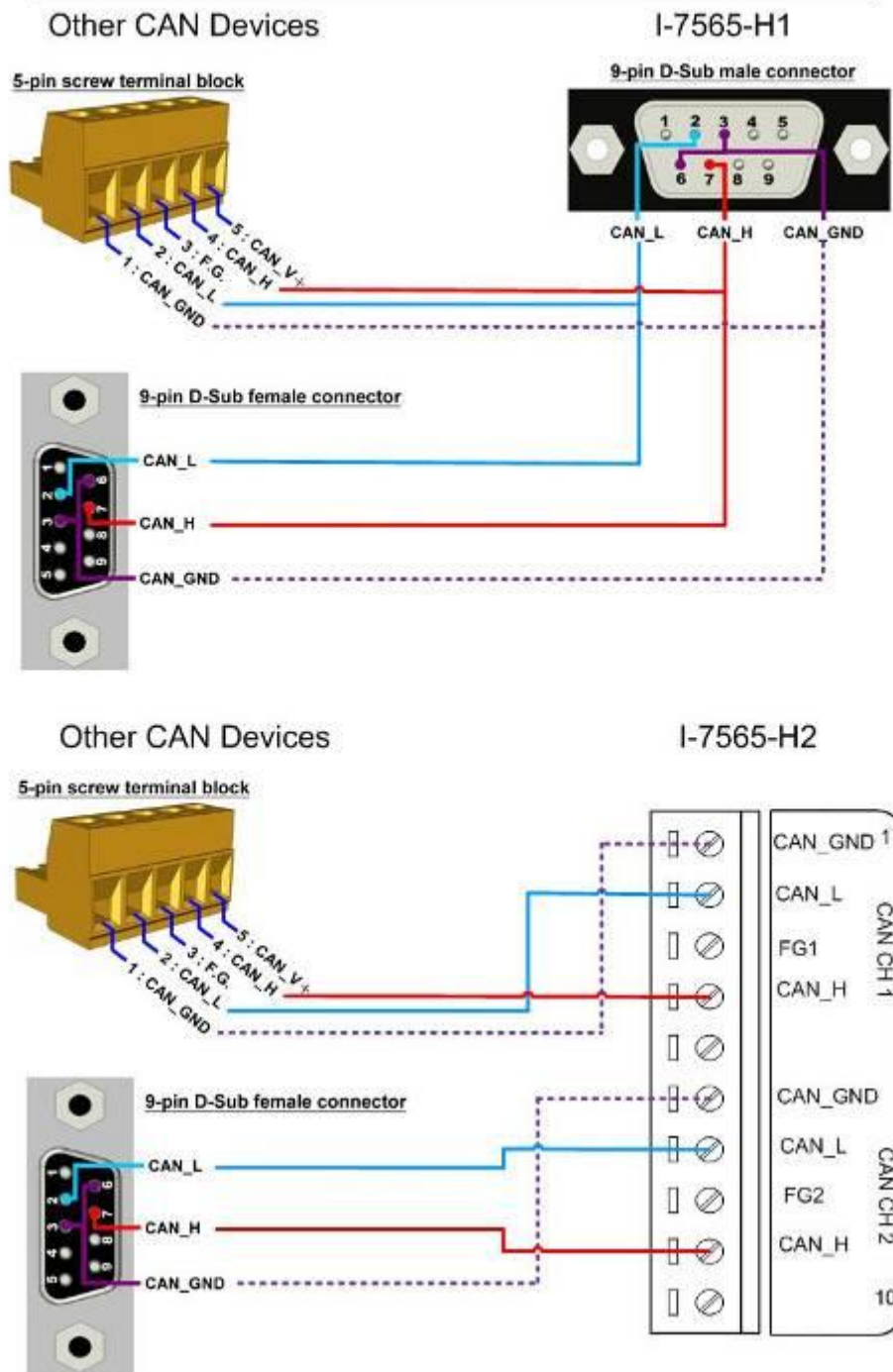

Figure 2-4: CAN Hardware Wire Connection

2.4 Terminator Resistor Settings

According to the ISO 11898 specifications, the CAN Bus network must be terminated by two terminal resistors (120Ω) for proper operation, as shown in the below figure.

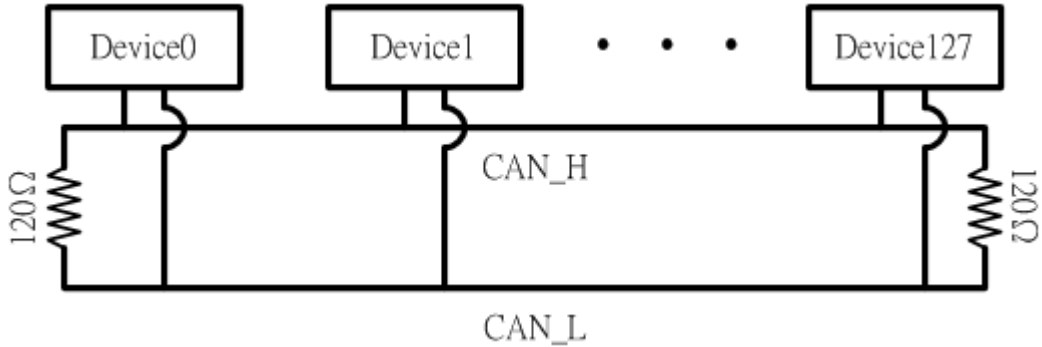

Figure 2-6: Terminal Resistor

Therefore, the I-7565-H1/H2 module supplies a jumper for users to activate the terminal resistor or not. If users want to use this terminal resistor, please open the I-7565-H1/H2 cover and use the JP3 for I-7565-H1 / JP3, JP4 for I-7565-H2 to activate the 120Ω terminal resistor built in the module, as the Figure 2-7. Note that the default setting is active.

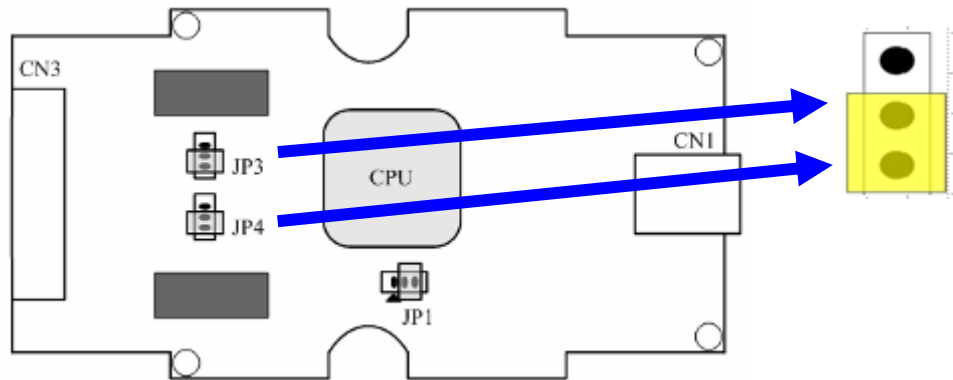

Figure 2-7: Terminal Resistor Jumper

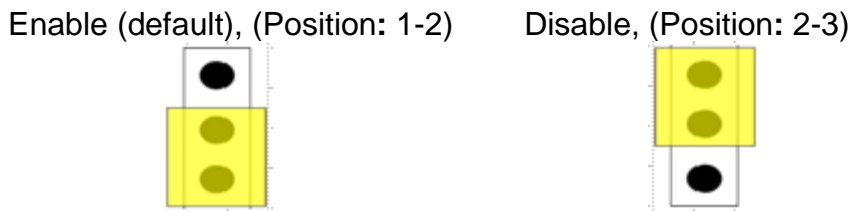

Figure 2-8: JP3/JP4 Jumper Position

2.5 Init / Normal Dip-switch

On the back of the I-7565-H1/H2 module, there is a dip-switch used for firmware operation or firmware updating of the module. The following steps show how to use this dip-switch.

2.5.1 Firmware Update Mode

Please set the dip-switch to the “Init” (Initial) position like Figure 2-9. Then the I-7565-H1/H2 will work in the “Firmware Update Mode” after the power of the module has been turned on again. In this mode, users can update the firmware of the I-7565-H1/H2 module via USB and the module will become a “USB Mass Storage Device” and also shows a folder like Figure 2-10 automatically.

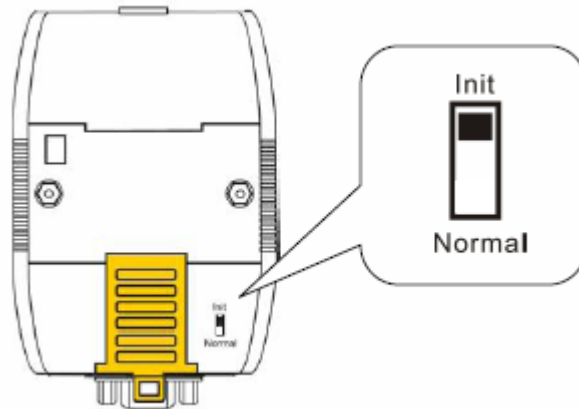

Figure 2-9: Init Position of Dip-Switch

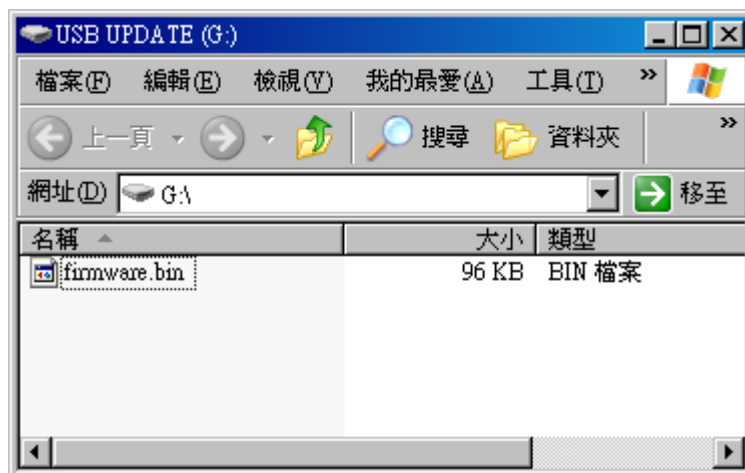

Figure 2-10: USB Mass Storage Device

Users just need to execute “[Firmware_Update_Tool.exe](#)” and follow

the below steps to complete the firmware updating process.

[1] Choose “**USB**” interface and “**USB Disk**”.

[2] Click “**Browser**” button to choose firmware file. (like **I7565H1_v1.01.fw**)

[3] Click “**Firmware Update**” button to start firmware updating process.

The result will show in “Firmware Update” field.

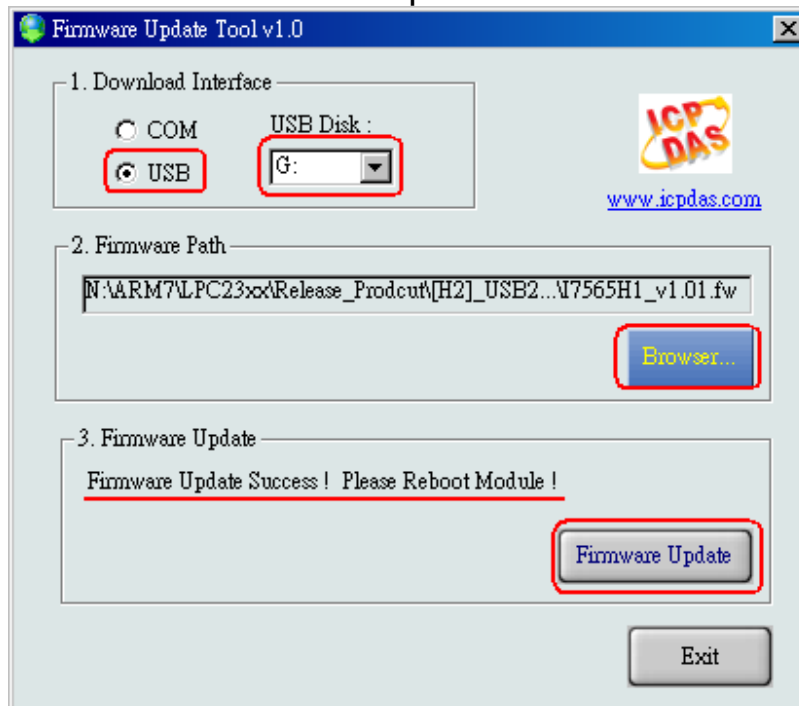

Figure 2-11: Normal Position of Dip-Switch

The Firmware_Update_Tool program can be downloaded from http://ftp.icpdas.com/pub/cd/fieldbus_cd/can/converter/i-7565-h1h2/software/tool

2.5.2 Firmware Operation Mode

In operation mode, users need to set the dip-switch to the “Normal” position like Figure 2-12 and turn the power off then on again so that the I-7565-H1/H2 can run in the operation mode. In this mode, users can send / receive CAN messages via PC USB port.

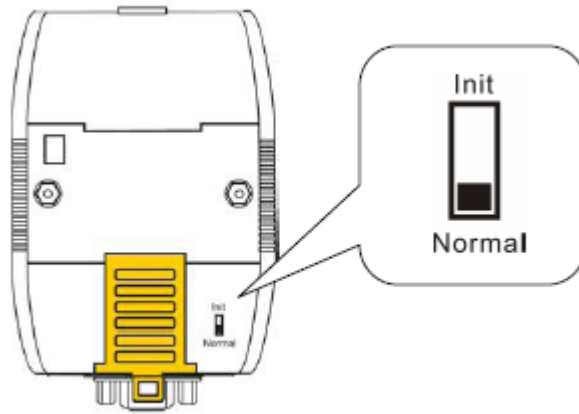

Figure 2-12: Normal Position of Dip-Switch

2.6 LED Indication

There are three LEDs provided to indicate to users what situation the I-7565-H1/H2 is in. The following is the illustration of these three LEDs and the position of these three LEDs shows as Figure 2-12.

(1) PWR LED :

It is used to help users to check whether the I-7565-H1/H2 is standby. If the module is working in “firmware operation” mode, the PWR LED is always turned on. However, when the module is working in the “firmware updating” mode, the PWR LED will flash approximately once per second.

(2) RUN LED :

It is used to show whether the I-7565-H1/H2 is transmitting/receiving CAN messages. The RUN LED will flash whenever a CAN message is sending or receiving. In I-7565-H2, the RUN LED is shared by CAN1 port and CAN2 port.

(3) ERR LED :

It is used for demonstrating an error that has occurred. The ERR LED is normally turned off when the module works in a good condition. When the Bus-Off error happened, the ERR LED will always turn on until the Bus-Off condition disappeared. If the CAN/USB buffer built in I-7565-H1/H2 overflows or CAN message can't be sent out successfully, then the ERR LED will flash continuously. In I-7565-H2, the ERR LED is shared by CAN1 port and CAN2 port.

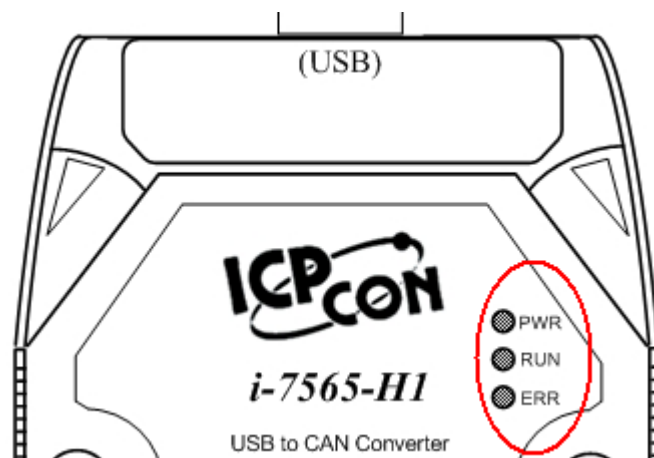

Figure 2-13: LED position of I-7565-H1/H2

Table 2: LED indication of I-7565-H1/H2

LED Name	I-7565-H1/H2 Status	LED Status
ALL LED	Hardware Init Fail	All LED always turned on permanently after reset
	Hardware WDT Fail	All LED flash per 2 second
	Contact to ICP DAS	All LED flash take turns
PWR LED	Firmware Updating Mode	Flash per second
	Firmware Operation Mode	Always turned on
	Power Off	Off
RUN LED	Transmission	Flash
	Bus Idle	Off
ERR LED	Transmission Fail	Flash per 100 ms
	Buffer Overflow	Flash per second
	Bus-Off	Always turned on
	No Error	Off

2.7 Cable Selection

The CAN bus is a balanced (differential) 2-wire interface running over either a Shielded Twisted Pair (STP), Un-shielded Twisted Pair (UTP), or Ribbon cable. The CAN-L and CAN-H Wire start on one end of the total CAN network that a terminator of 120 Ohm is connected between CAN-L and CAN-H. The cable is connected from CAN node to CAN node, normally without or with short T connections. On the other end of the cable again a 120Ω(Ohm) terminator resistor is connected between the CAN lines. How to decide a cable type, cable length, and terminator depends on the baud rate in the CAN bus network, please refer to the following table 3.



Figure 2-14: Un-shielded Twisted Pair (UTP)

Table 3: Cable selection

Bus speed	Cable type	Cable Resistance/m	Terminator	Bus Length
50k bit/s at 1000m	0.75~0.8mm ² 18AWG	70 mOhm	150~300 Ohm	600~1000m
100k bit/s at 500m	0.5~0.6 mm ² 20AWG	< 60 mOhm	150~300 Ohm	300~600m
500k bit/s at 100m	0.34~0.6mm ² 22AWG, 20AWG	< 40 mOhm	127 Ohm	40~300m
1000k bit/s at 40m	0.25~0.34mm ² 23AWG, 22AWG	< 40 mOhm	124 Ohm	0~40m

Note: The AWG means a standard method used to measure wire. The numbering system works backwards from what people would think, the thicker (heavier) the wire, the lower the number. For example: a 24AWG wire is thicker/heavier than a 26AWG wire.

3. Driver Installation

This section will show how to install the I-7565-H1/H2 USB/CAN converter device driver under Windows 2000/XP and Win7. Users can download the I-7565-H1/H2 device driver from ICP DAS web site: http://ftp.icpdas.com/pub/cd/fieldbus_cd/can/converter/i-7565-h1h2/driver. Please follow the below steps to finish I-7565-H1/H2 driver installation.

3.1 Install I-7565-H1/H2 Driver by Auto

[Step - 1]

Plug in the I-7565-H1 or I-7565-H2 to PC first and Windows will detect the new device and shows the “Found New Hardware Wizard” screen prompting you to install the driver for the detected USB Device. Please click “Cancel” button to cancel driver installation by manual like Figure 3-1.



Figure 3-1: New Hardware Wizard (1)

[Step - 2]

Execute “I7565H1H2_DrvInst.exe” file to install driver automatically and then click “Continue Anyway” button like Figure 3-2. After driver installation process finished, it will show the screen like Figure 3-3.



Figure 3-2: New Hardware Wizard (2)

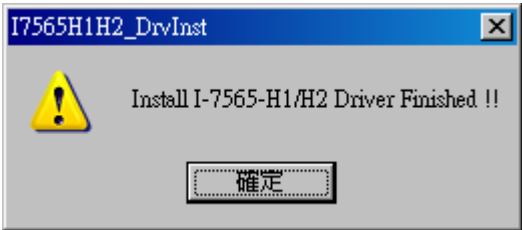

Figure 3-3: Install I-7565-H1/H2 Driver Finished

3.2 Install I-7565-H1/H2 Driver by Manual

[Step - 1]

Please execute “**ICPUsbConverter_DrvInst.exe**” (the driver file name for v1.2 or newer) file first to install necessary driver files of I-7565-H1/H2 to system.

[Step - 2]

Plug in the I-7565-H1 or I-7565-H2 to PC and Windows will detect the new device and shows the “Found New Hardware Wizard” screen prompting you to install the driver for the detected USB Device. Please select “No, not this time” option and click “Next” button like Figure 3-4.



Figure 3-4: New Hardware Wizard (1)

[Step - 3]

Please select “install from a list or specific location (Advanced)” option and click “Next” button like Figure 3-5.



Figure 3-5: New Hardware Wizard (2)

[Step - 4]

Please select “Search for the best driver in these locations” option and check “include this location in the search:” checkbox and click “Browser” button to assign the I-7565-H1/H2 driver location - C:\WINDOWS\inf\ and then click “Next” button like Figure 3-6.



Figure 3-6: New Hardware Wizard (3)

[Step - 5]

Please click “Continue Anyway” button like Figure 3-7 .



Figure 3-7: New Hardware Wizard (4)

[Step - 6]

Please click “Finish” button to complete I-7565-H1/H2 device driver installation like Figure 3-8.



Figure 3-8: New Hardware Wizard (5)

3.3 Verify Driver Installation

This section will show how to verify whether the driver of I-7565-H1/H2 was properly installed. If the driver is installed successfully, then there will be a “Virtual COM Port” assigned by Windows. Please follow the below steps to check it.

Click “**Start**” → “**Settings**” → “**Control Panel**” and then double click on the “**System**” icon. Once the “**System Properties**” screen displayed, click on “**Hardware**” tab and then click on the “**Device Manager**” button. Double-click on **Ports (COM & LPT)** item. If the device driver was correctly installed, users can find the “ICPDAS I-7565-H1 USB2CAN” or “ICPDAS I-7565-H2 USB2CAN” device listing and the “Virtual COM Port” number that Windows has assigned to the device is **COM3** like Figure 3-9.

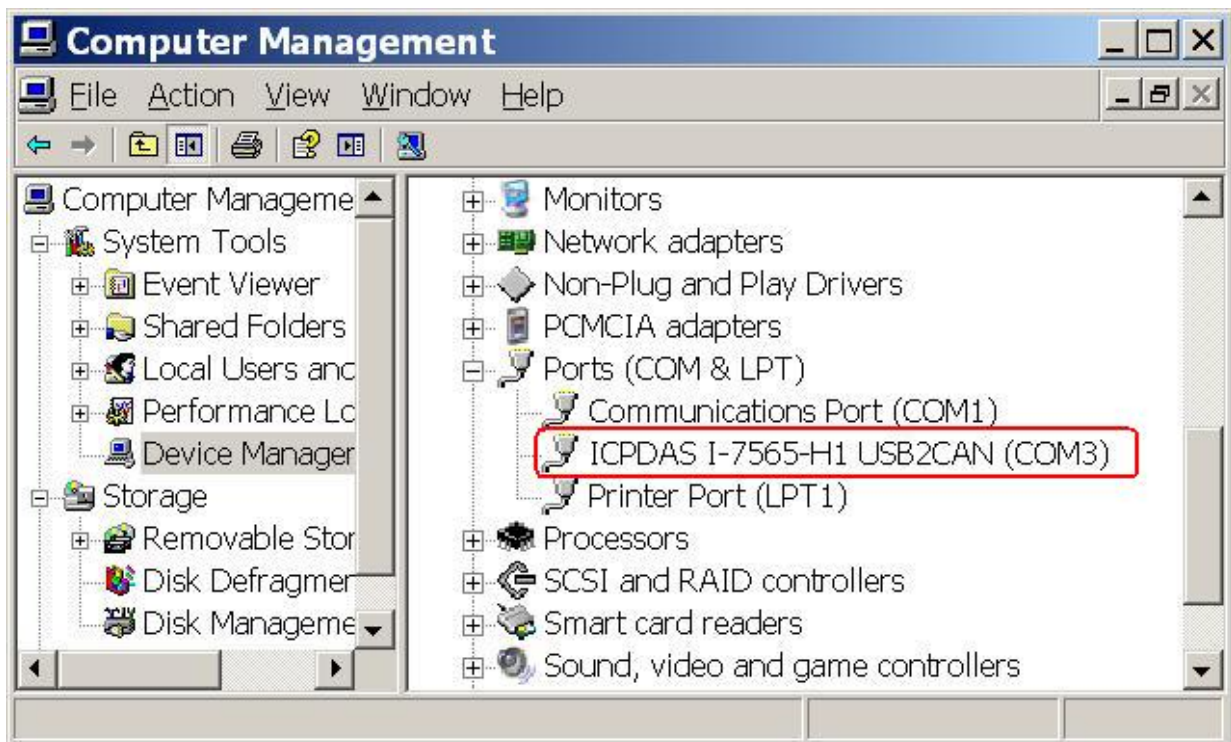

Figure 3-9: Virtual COM Port Number

3.4 Uninstall I-7565-H1/H2 Driver

Please follow the below steps to uninstall I-7565-H1/H2 device driver.

[Step - 1]

Click **“Start”** → **“Settings”** → **“Control Panel”** and then double click on the **“System”** icon. Once the **“System Properties”** screen displayed, click on **“Hardware”** tab and then click on the **“Device Manager”** button. Double-click on **Ports (COM & LPT)** item. Please find the **“ICPDAS I-7565-H1 USB2CAN”** or **“ICPDAS I-7565-H2 USB2CAN”** device listing and right click mouse button on it and choose **“Uninstall”** item like Figure 3-10.



Figure 3-10: Uninstall I-7565-H1/H2 Driver (1)

[Step - 2]

Click **“OK”** button to complete I-7565-H1/H2 device driver un-installation like Figure 3-11. After that, the **“ICPDAS I-7565-H1 USB2CAN”** or **“ICPDAS I-7565-H2 USB2CAN”** device listing will disappear on **Ports (COM & LPT)** item.



Figure 3-11: Uninstall I-7565-H1/H2 Driver (2)

4. Software Utility

I-7565-H1/H2 Utility is provided by ICP DAS to transmit / receive CAN messages for CAN bus communication testing easily and quickly. In the meanwhile, it can also display the time-stamp of each received CAN message for data analyzing conveniently. I-7565-H1/H2 Utility can be downloaded from the ICP DAS web site :

http://ftp.icpdas.com/pub/cd/fieldbus_cd/can/converter/i-7565-h1h2/software/utility. The following is the main functions provided by I-7565-H1/H2 Utility :

4.1 INI File Function

Whenever users execute the I-7565-H1/H2 Utility, it will look for the INT file : **I-7565-H1H2 Utility.ini** first to load the initial connection setting. If the INI file doesn't exist, then it will load the default setting. The below is the format illustration of the INI file like Figure 4-1.

- [1] **COM** : The Virtual COM Port Number.
- [2] **TYPE** : 1: I-7565-H1; 2: I-7565-H2.
- [3] **C1BR** : CAN1 Baud Rate
- [4] **C2BR** : CAN2 Baud Rate
- [5] **C1EN** : CAN1 Port Function. (1: Enable; 0: Disable)
- [6] **C2EN** : CAN2 Port Function. (1: Enable; 0: Disable)
- [7] **C1LOM** : CAN1 Listen Only Mode (1: Enable; 0: Disable)
- [8] **C2LOM** : CAN2 Listen Only Mode (1: Enable; 0: Disable)
- [9] **SYMFILE**: Load Symbol Initial File (I-7565-H1H2_SymFile.ini)
Automatically (1: Enable; 0: Disable) => Supported in
Utility v1.10

```
COM=1 TYPE=1 C1BR=1000 C2BR=1000 C1EN=1 C1LOM=0 C2EN=1 C2LOM=0 SYMFILE=1
```

Figure 4-1: INI file Parameters of I-7565-H1/H2 Utility

4.2 Connection Function

When users execute the I-7565-H1/H2 Utility, it will show connection function screen first for connecting to I-7565-H1/H2 like Figure 4-2-1. The following is the illustration for connection parameters.

- [1] **Com Port** : The Virtual COM Port Number.

- [2] **Mod Name** : The Module Name.
- [3] **CAN Port Enable** : Enable CAN Port Function. (Checked: Enable)
 (3.1) Listen Only Mode : Enable Listen Only mode
- [4] **CAN Baud Rate** : CAN bus Baud Rate Setting.

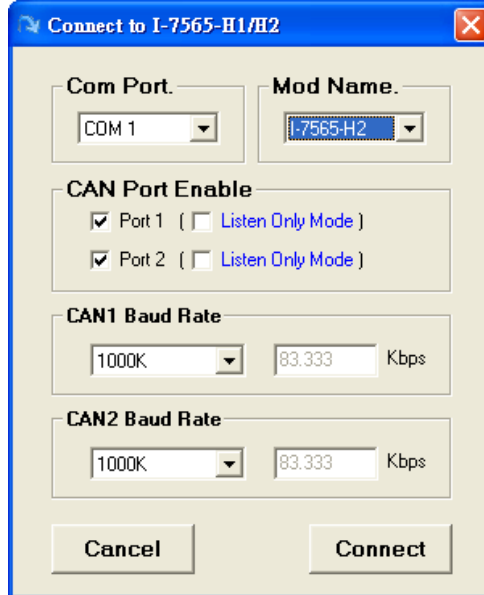

Figure 4-2-1: Connection Screen of I-7565-H1/H2 Utility

[Note]

1. The user-defined CAN baud rate setting :

If users want to use the user-defined CAN baud rate, in the “Connect to I-7565-H1/H2” screen of “I-7565-H1/H2 Utility”, users can choose the “**Defined**” item and input the user-defined CAN baud rate value (for example: 83.333) in the right field of the “Baud Rate” frame like Figure 4.2-2. Then click “Connect” button to connect to I-7565-H1/H2.

In FW_v1.07, add the adjustable sample point (Tseg2 Value) of “CAN Baud Bit-Timing” function and the value of Tseg2 can be from 2 to 6. When I-7565-H1/H2 is used in the CAN bus occasion filled with electromagnetic interference (such as: motor starts causing interference), then users can use the bigger Tseg2 value in the same baudrate for CAN bus communication.

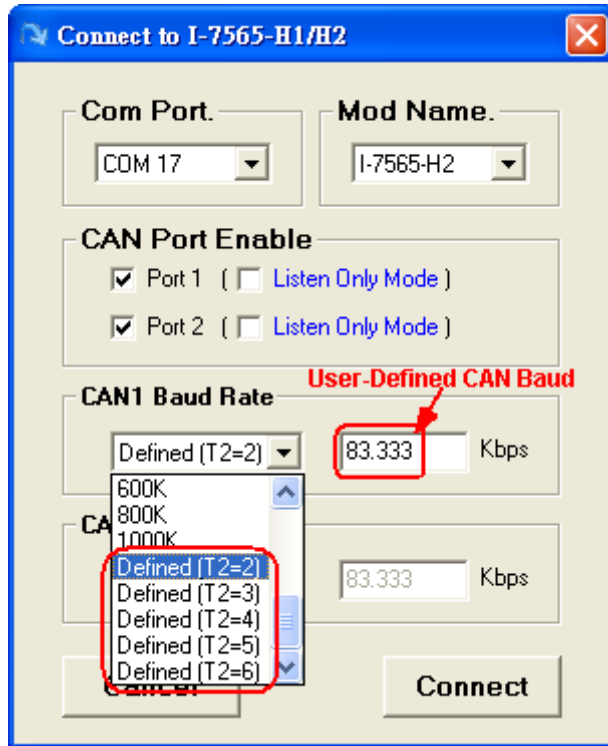

Figure 4.2-2: User-defined CAN Baud Rate for I-7565-H1/H2

2. “Listen Only Mode” (LOM) function :

It is supported by I-7565-H1/H2 Utility v1.09 and FW v1.05 or newer. The LOM screen is like Figure 4-2-3. (In LOM, CAN message sending function is disabled.)

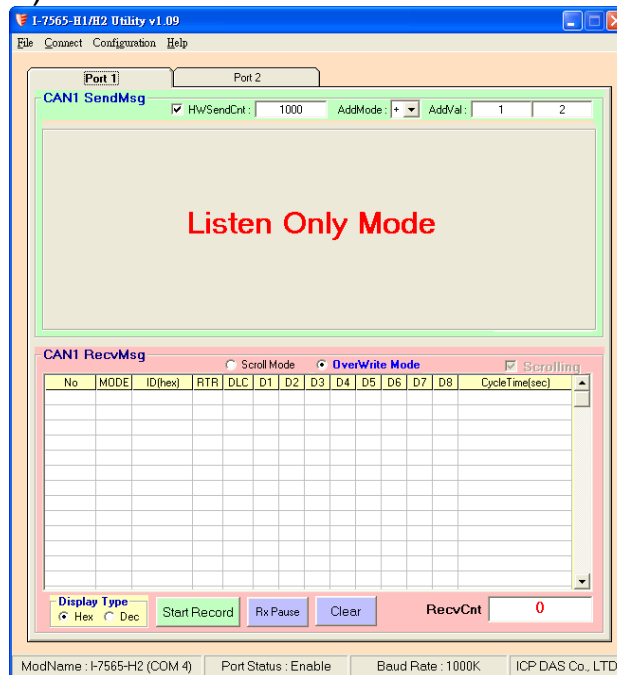

Figure 4-2-3: LOM Screen of I-7565-H1/H2 Utility

After finish the connection setting, please click “**Connect**” button to

connect to I-7565-H1/H2 module. Note that I-7565-H1/H2 doesn't affect the CAN bus communication when power on because the CAN port function will keep disabled until users connect to I-7565-H1/H2 successfully. As soon as users disconnect to I-7565-H1/H2, the CAN port function on I-7565-H1/H2 will be disabled again. Besides, users can also click "Connect" item in the menu bar and choose "Connect To I-7565-H1/H2" function to connect to I-7565-H1/H2 like Figure 4-2-4 or "Disconnect" function to disconnect to I-7565-H1/H2 like Figure 4-2-5.

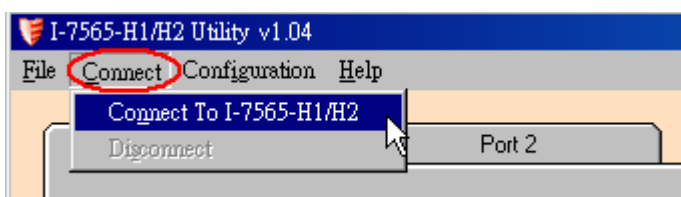

Figure 4-2-4: "Connect To I-7565-H1/H2" function

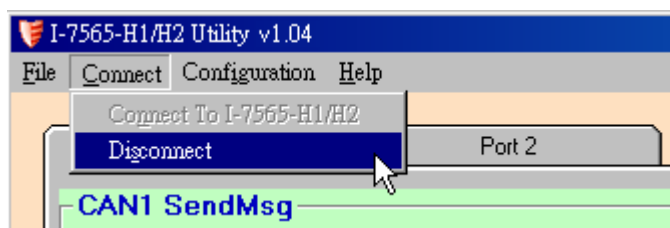

Figure 4-2-5: "Disconnect" function

4.3 Communication Function

If the connection to I-7565-H1/H2 is successful, then the screen for CAN bus communication function will show up like the Figure 4-5.

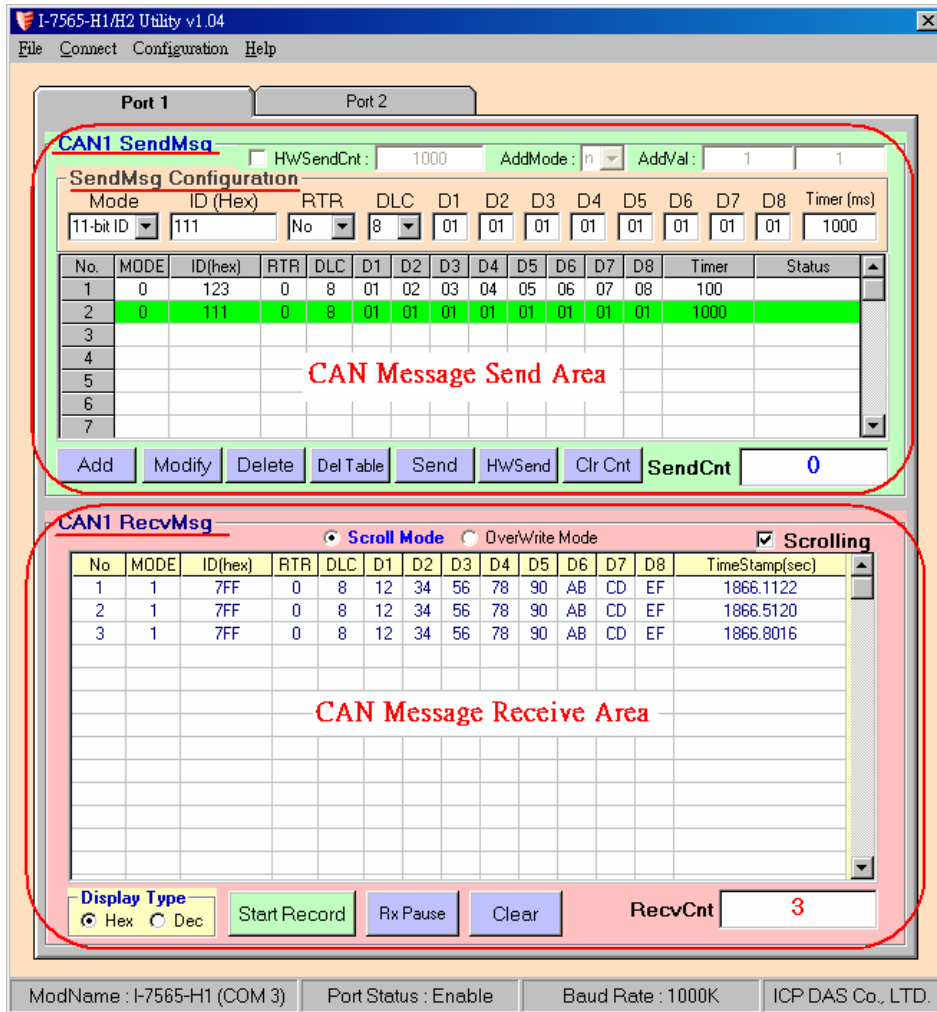

Figure 4-5: Communication Screen of I-7565-H1/H2 Utility

The following is the illustration for the communication screen and it can be divided to two blocks in each CAN port function. One is “SendMsg” block and the other is “RecvMsg” block. Besides, “Port 1” / “Port 2” tab is used to switch CAN1 / CAN2 communication screen.

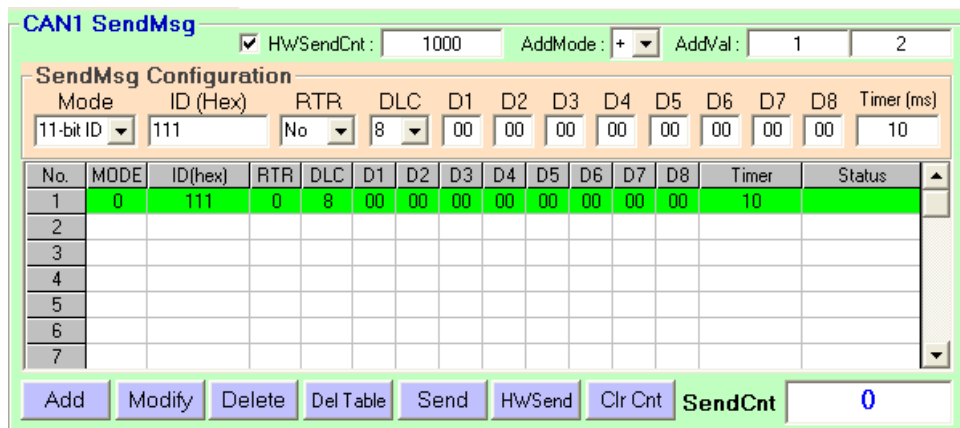

Figure 4-6-1: Send CAN Message Area

[1] For “CAN1/2 SendMsg” block :

<1> “**SendMsg Configuration**” frame :

It is used to edit the CAN message parameters and users can use “Add” button to add the CAN message to “CAN Message Send Area”.

<2> “**Add**” button :

It will add the CAN message from “SendMsg Configuration” area to the last row in “CAN Message Send Area”.

<3> “**Modify**” button :

It will modify the CAN message parameter from “SendMsg Configuration” area to the assigned green row in “CAN Message Send Area”.

<4> “**Delete**” button :

It will delete the CAN message of the assigned green row in “CAN Message Send Area”.

<5> “**Del Table**” button :

It will delete all the CAN messages in “CAN Message Send Area”.

<6> “**Send**” button :

It will send the CAN message of the assigned green row in “CAN Message Send Area”. If the value in the “Timer” field is zero, it will just send once. If not, it will send continuously by PC timer.

<7> “**HWSend**” button :

It will send the CAN message of the assigned green row in “CAN Message Send Area”. If the value in the “Timer” field is zero, it will just send once. If not, it will send continuously by module hardware timer and it will be more precise than PC timer. If users want to send the CAN message with fixed number, then before clicking “HWSend” button, please check the “HWSendCnt” checkbox first and input the count in the field like Figure 4-6-1.

In “AddMode” field, it is used to set the CAN Data value addition mode. The ‘n’ option is “disable” mode, the ‘+’ option is “addition” mode and the ‘x’ option is “multiple” mode. In “AddVal” field, the first field is used for CANL Data and the second field is used for CANH Data.

<8> “**Clr Cnt**” button :

It will clear the “SendCnt” value to be zero in “CAN Message Send Area”.

<9> “**SendCnt**” field :

Whenever the CAN message is sent out once, the “SendCnt” value will be added by 1 except “HWSend” function.

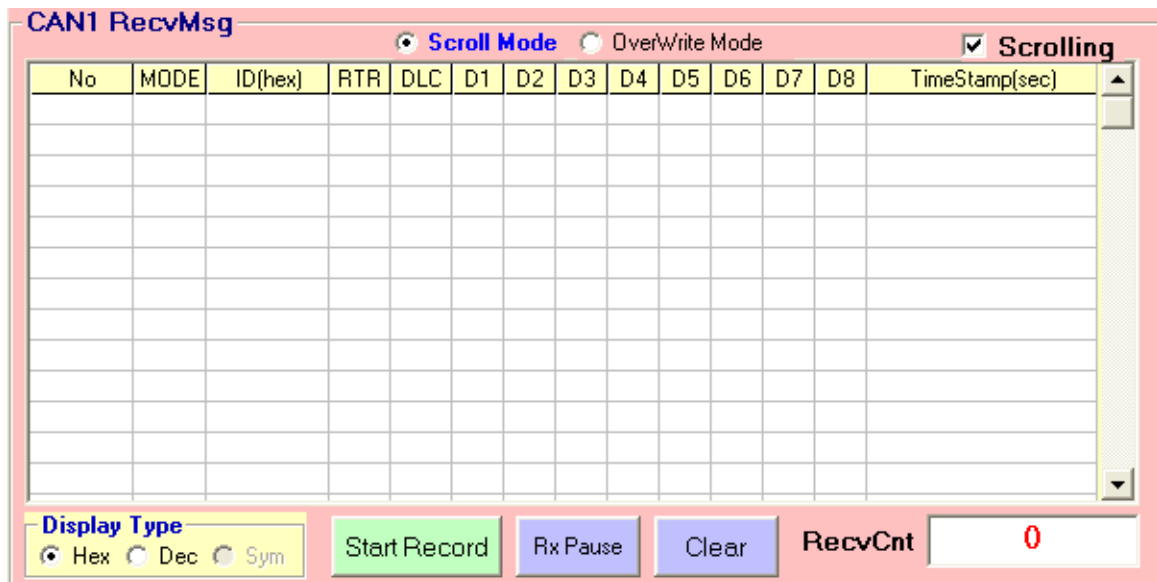

Figure 4-6-2: Recv CAN Message Area

[2] For “CAN1/2 RecvMsg” block :

<1> “**Display Type**” option :

Hex : Used to show the ID and Data with “Hex” format in “CAN Message Receive Area”.

Dec : Used to show the ID and Data with “Decimal” format in “CAN Message Receive Area”.

Sym : Used to show the ID with “Symbolic Name” in “CAN Message Receive Area”. (Only supported in OverWrite mode and need to install symbolic file first. Provided in Utility_v1.10 or newer)

The following is the demo of symbolic name file.

[CAN1Sym]

SymNum=2

ID1=0x100

Name1=Engine Speed

ID2=0x101

Name2=Engine Temp.

[CAN2Sym]

SymNum=1

ID1=0x200

Name1=Motor Speed

[CAN1Sym] : For CAN1 Symbolic Name Setting

SymNum : Symbolic Name Total Number

ID1 : The First Set CANID Value (HEX)

Name1 : The First Set CANID Symbolic Name

⇒ After loading the above symbolic name file, in OverWrite mode, choose the “Sym” option. When receiving the CANMsg with CANID=0x100 in “CAN1 RecvMsg” table, it will show the symbolic name in ID field to replace the original 100 value like Figure 4-6-3 and Figure 4-6-4.

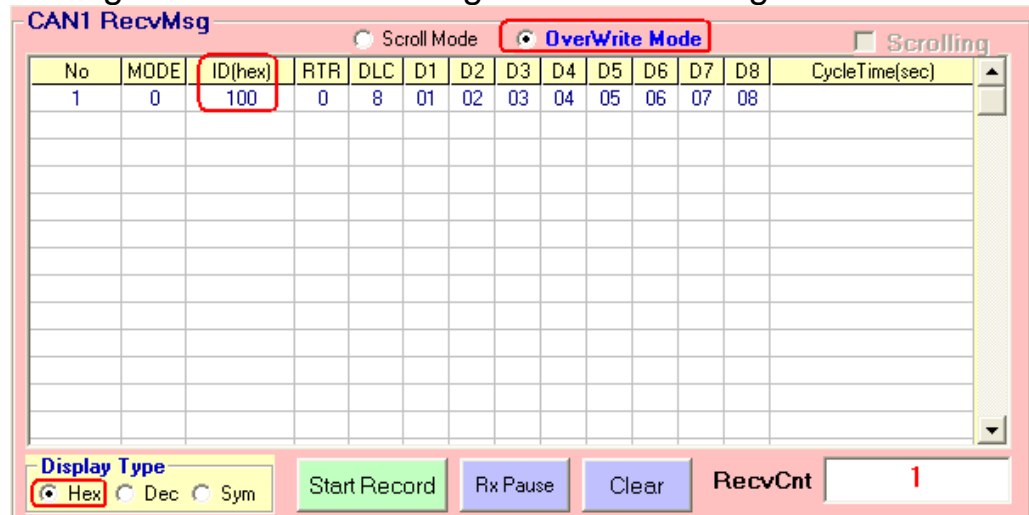

Figure 4-6-3: “Hex” type in OverWrite mode

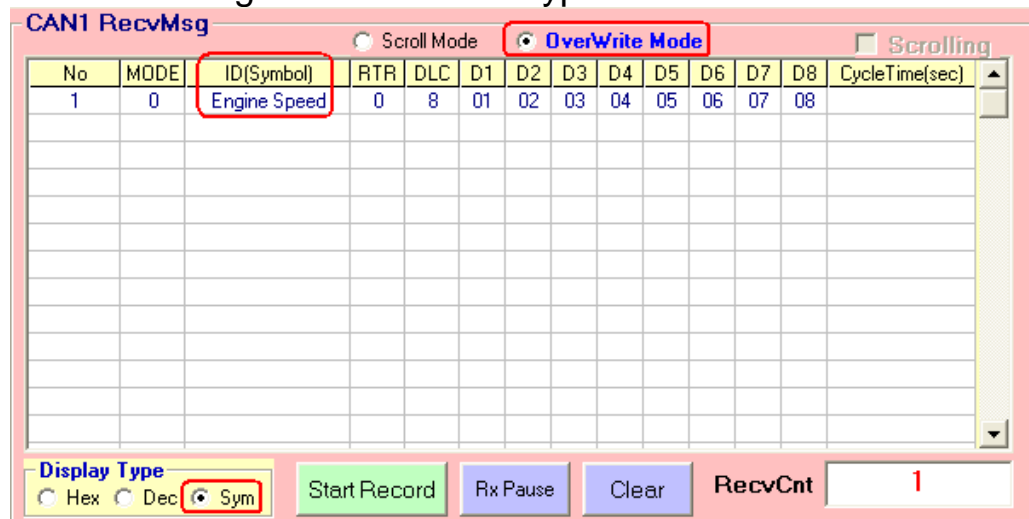

Figure 4-6-4: “Sym” type in OverWrite mode

<2> “Start Record / Stop Record” button :

When clicking “Start Record” button, the received CAN messages will be recorded in a file as ASCII text replacing showing in “CAN Message Send Area”. When clicking “Stop Record” button, it will stop recording the received CAN messages on a file.

The filename format will be “CAN1_YYMMDD_HHMMSS.txt” or “CAN2_YYMMDD_HHMMSS.txt”.

<3> **“Rx Pause / Rx Start”** button :

When clicking “Rx Pause” button, it will stop receiving the CAN messages. When clicking “Rx Start” button, it will start to receive the CAN messages.

<4> **“Clear”** button :

It will clear all the CAN message data in “CAN Message Receive Area” and the “RecvCnt” value to be zero.

<5> **“Scrolling”** checkbox :

If the “Scrolling” checkbox is checked, the received CAN message data in “CAN Message Receive Area” will be updated and the “RecvCnt” value to be the newest automatically. If not, it will not update the received CAN message data in “CAN Message Receive Area”.

<6> **“Scroll / OverWrite Mode”** option : (Supported in Utility v1.09)

“Scroll Mode” option :

The received CAN message data will be shown in RecvTable by sequence.

“OverWrite Mode” option :

If the MODE and ID value are all the same of the received CAN message data, then they will be placed in the same row of RecvTable. The “No” field will be the number of the same CAN message and the “CycleTime” field includes the period and the Max/Min time interval of the same CAN message.

The “CycleTime” field description is as below.

[1] 0.4964 (Sec) => CAN Message Period (about 500ms)

[2] 0.5002 (Sec) => The Max. time interval of CAN message.

[3] 0.4800 (Sec) => The Min. time interval of CAN message.

Num	MODE	ID(hex)	RTR	DLC	D1	D2	D3	D4	D5	D6	D7	D8	CycleTime(sec)
35	0	123	0	8	02	33	44	AF	BC	DD	EE	FF	0.4964 (0.5002/0.4800)

Figure 4-6-5: OverWrite mode

4.4 Config Function

In I-7565-H1/H2 Utility, it provides two kinds of configuration functions. One is “Module Config” and the other is “Advanced Config”. Users can click “Configuration” item in the menu bar and choose one of them to show the corresponding function screen like Figure 4-7.

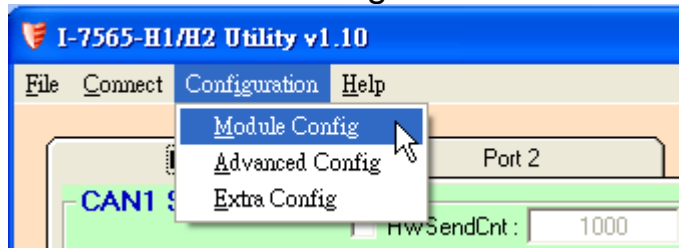

Figure 4-7: Configuration Function of I-7565-H1/H2 Utility

4.4.1 Module Config Function

The following is the illustration for “Module Config” screen. It can be divided to two blocks. One is “CAN Filter Setting” block and the other is “Config / Info Option” block like Figure 4-8.

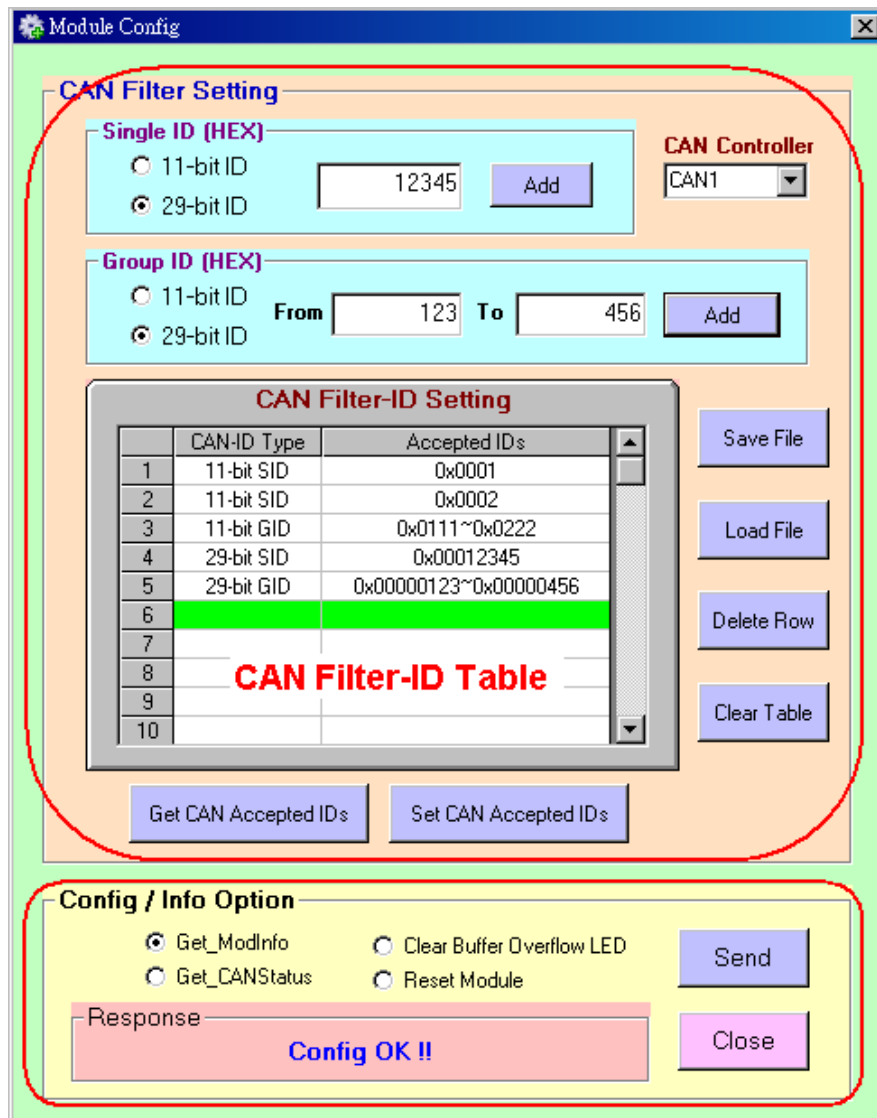

Figure 4-8: Module Config Screen of I-7565-H1/H2 Utility

[1] For “CAN Filter Setting” block :

If users don't set the CAN Filter function, then all CAN messages will be able to be received in default. In “CAN Filter Setting” block, users can set which CAN ID able to be received by I-7565-H1/H2 module.

<1> “Single ID” frame :

By clicking “Add” button to add the assigned single CAN ID to “CAN Filter-ID Table” to set these assigned single CAN ID able to be received.

<2> “Group ID” frame :

By clicking “Add” button to add the assigned group CAN ID to “CAN Filter-ID Table” to set these assigned group CAN ID able to be received.

<3> **“CAN Controller”** combobox :

It is used to choose which CAN port that users want to configure currently.

<4> **“Get CAN Accepted IDs”** button :

It is used to get CAN Filter-ID data of the assigned CAN port and showed in the “CAN Filter-ID Table”. The command result also returns in the “Response” frame of “Config / Info Option” block.

<5> **“Set CAN Accepted IDs”** button :

It is used to set CAN Filter-ID data of the assigned CAN port according to the “CAN Filter-ID Table” content. The command result also returns in the “Response” frame of “Config / Info Option” block.

<6> **“Save File”** button :

It is used to save the “CAN Filter-ID Table” content to file.

<7> **“Load File”** button :

It is used to load the CAN Filter-ID data from file to “CAN Filter-ID Table”.

<8> **“Delete Row”** button :

It is used to delete the CAN Filter-ID data of the assigned green row in “CAN Filter-ID Table”.

<9> **“Clear Table”** button :

It is used to clear all the contents in “CAN Filter-ID Table”.

[2] For “Config / Info Option” block :

There are several option functions provided for I-7565-H1/H2. The following will illustrate all these functions.

<1> **“Get_ModInfo”** option :

It is used to get the related module info including “Module Name”, “Firmware Version” and “Hardware Serial Number” like Figure 4-9.

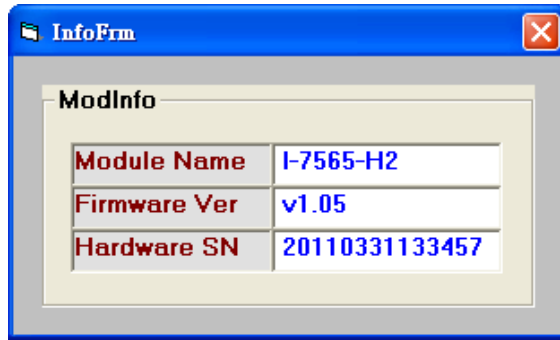

Figure 4-9: Module Info

[Note]

1. “Hardware Serial Number” function is supported by I-7565-H1/H2 v1.08 and firmware v1.04 or newer.

<2> “**Get_CANStatus**” option :

It is used to get the assigned CAN port status like Figure 4-10.

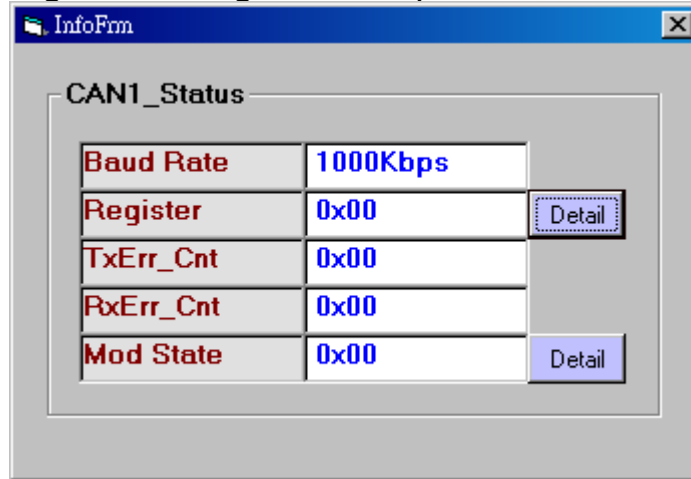

Figure 4-10: CAN Status

In “**Register**” item, clicking the “**Detail**” button it will show the more detailed CAN port register status like Figure 4-11. If the corresponding bit is 1, it means that the corresponding state happened.

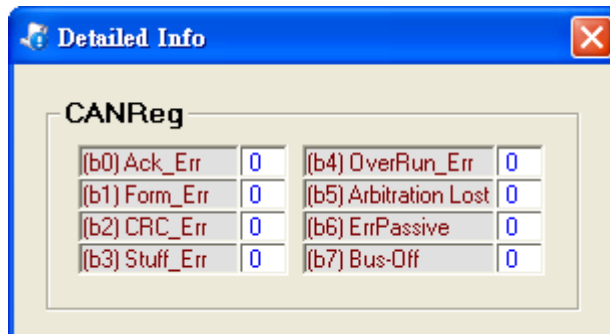

Figure 4-11: CAN Register Detailed Information

In “**Mod State**” item, clicking the “**Detail**” button it will show the more detailed module status like Figure 4-12. If the corresponding bit is 1, it means that the corresponding state happened.

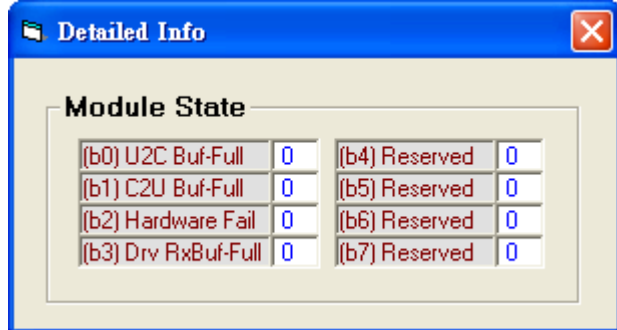

Figure 4-12: module state Detailed Information

- (1) U2C Buf-Full :
Module USB to CAN hardware buffer overflow happened.
- (2) C2U Buf-Full :
Module CAN to USB hardware buffer overflow happened.
- (3) Hardware Fail :
Module hardware (like : CAN port...) initialized failed.
- (4) Drv RxBuf-Full :
Software buffer overflow of I-7565-H1/H2 Utility happened.

- <3> “**Clear Buffer Overflow LED**” option :
When CAN/USB buffer overflows, then the ERR LED will flash one second permanently. The button is used to clear the ERR LED flash state.
- <4> “**Reset Module**” option :
It is used to reset I-7565-H1/H2 remotely.

4.4.2 Advanced Config Function

The following is the illustration for “Advanced Config” screen like Figure 4-13 and Figure 4-14.

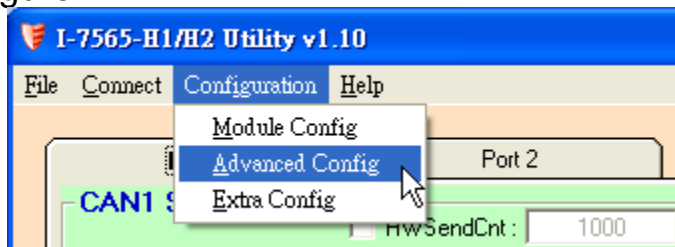

Figure 4-13: Configuration Function of I-7565-H1/H2 Utility

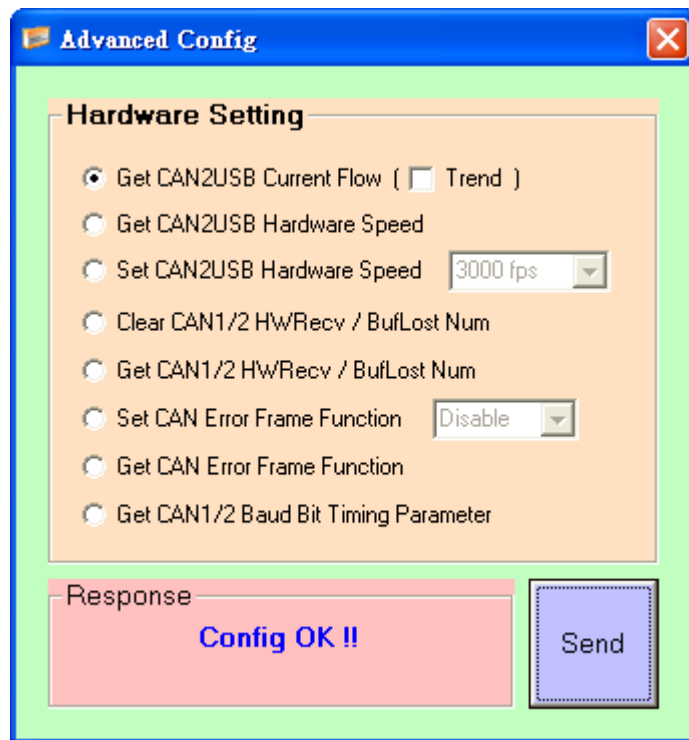

Figure 4-14: Advanced Config of I-7565-H1/H2

<1> **“Get CAN2USB Current Flow”** option :

It is used to get the current CAN message flow (unit: fps) in the CAN port of I-7565-H1/H2.

If the **“Trend”** option is checked, then it will open the CAN bus flow trend screen like Figure 4-14-1. This function is supported in Utility v1.09 or newer.

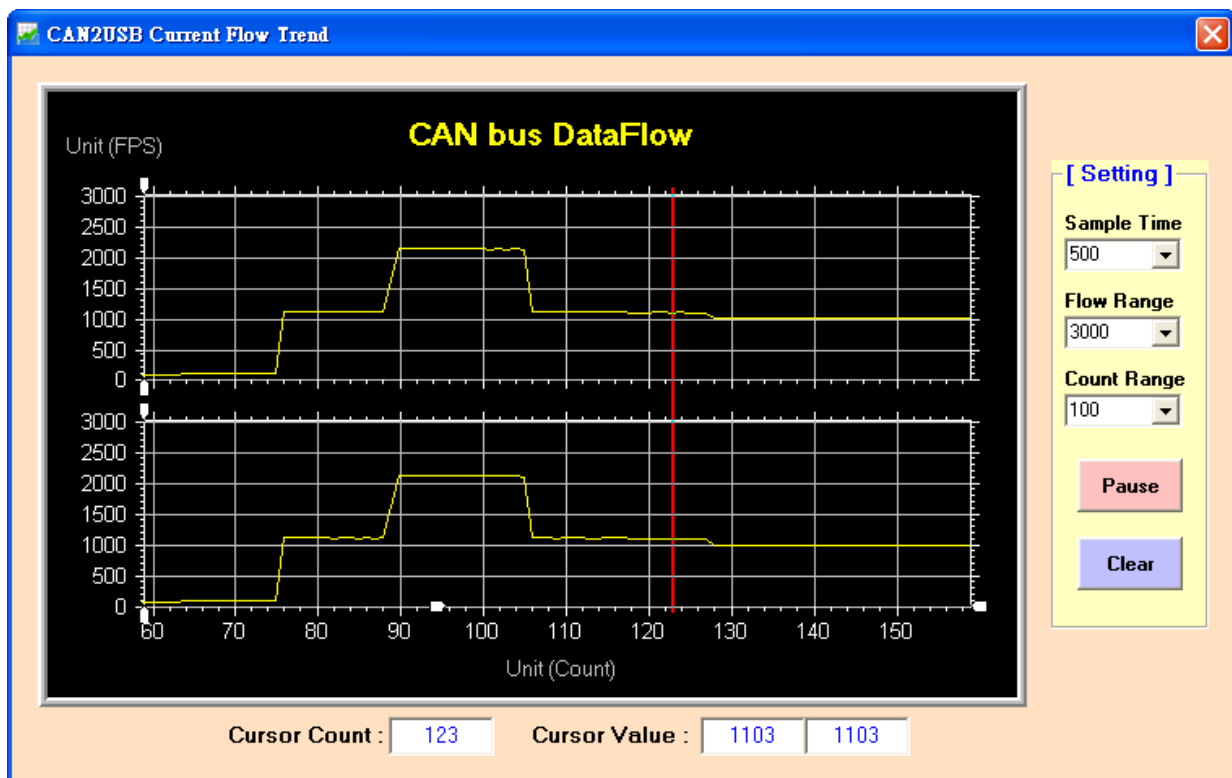

Figure 4-14-1: CAN bus Flow Trend

- <2> **“Get CAN2USB Hardware Speed”** option :
It is used to get the current setting value for CAN to USB hardware transmission speed of I-7565-H1/H2.
- <3> **“Set CAN2USB Hardware Speed”** option :
It is used to set CAN to USB hardware transmission speed of I-7565-H1/H2 module. Users can set the speed from 1000 fps ~ 3000 fps. The setting rule is that users can use “Get CAN2USB Current Flow” function first to know the current CAN message flow and then choose a setting value that is larger a little than that. Apply the rule and it will reduce the CAN message loss condition especially when the performance on users’ PC is not good.
- <4> **“Clear CAN1/2 HWRecv / BufLost Num”** option :
It is used to clear the total received number and buffer lost number of CAN1 and CAN2 message in module hardware.
- <5> **“Get CAN1/2 HWRecv / BufLost Num”** option :
It is used to get the total received number and buffer lost number of CAN1 and CAN2 message in module hardware.
- <6> **“Set CAN Error Frame Function”** option :
It is used to set the “CAN Error Frame” information function

enabled or disabled. If it is enabled, then when any error happened in CAN bus, the CAN error frame will be shown in the “CAN RecvMsg” field like Figure 4-14-2. The format of “CAN Error Frame” is fixed as below.

- (1) Mode=1 (29-bit)
- (2) ID=0xEEEEEEEE
- (3) RTR=0
- (4) DLC=8
- (5) D8=0xE1 (For CAN1), D8=0xE2 (For CAN2)
- (6) D0~D7 => CAN Error Information

No	MODE	ID(hex)	RTR	DLC	D1	D2	D3	D4	D5	D6	D7	D8	TimeStamp(sec)
37	1	EEEEEEEE	0	8	80	00	03	00	00	E8	00	E2	9406.1949
38	1	EEEEEEEE	0	8	80	00	03	00	00	F0	00	E2	9406.1949
39	1	EEEEEEEE	0	8	80	00	03	00	00	F8	00	E2	9406.1950
40	1	EEEEEEEE	0	8	84	00	03	00	00	7F	01	E2	9406.1950
41	1	EEEEEEEE	0	8	80	00	0A	00	00	08	00	E2	9406.2728
42	1	EEEEEEEE	0	8	80	00	0A	00	00	18	00	E2	9406.2729
43	1	EEEEEEEE	0	8	80	00	11	00	00	48	00	E2	9406.2729
44	1	EEEEEEEE	0	8	84	00	11	00	00	68	00	E2	9406.2729
45	1	EEEEEEEE	0	8	A0	00	11	00	00	88	00	E2	9406.2729
46	1	EEEEEEEE	0	8	80	00	06	00	00	90	00	E2	9406.2729
47	1	EEEEEEEE	0	8	80	00	0A	00	00	98	00	E2	9406.2730
48	1	EEEEEEEE	0	8	80	00	03	00	00	A0	00	E2	9406.2731
49	1	EEEEEEEE	0	8	80	00	03	00	00	A8	00	E2	9406.2731

Figure 4-14-2: CAN Error Frame

When clicking the column of CAN Error Frame like column 38, then it will show the detailed error information of the CAN Error Frame including arbitration error and bus error like Figure 4-14-3.

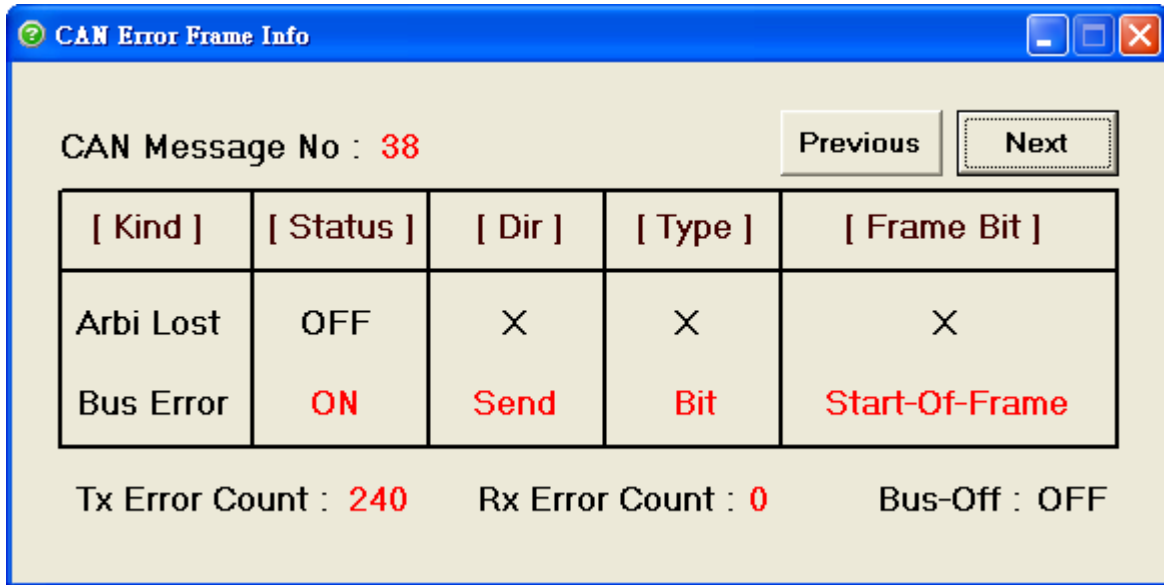

Figure 4-14-3: CAN Error Frame Information

<7> **“Get CAN Error Frame Function”** option :

It is used to get the “CAN Error Frame” function enabled or disabled.

<8> **“Get CAN1/2 Baud Bit Timing Parameter”** option :

It is used to get the CAN Baud Bit-Timing parameters of CAN1 and CAN2 in I-7565-H1/H2 like Figure 4-14-4. It can be used to check if these parameters are the same between I-7565-H1/H2 and other CAN devices when CAN bus communication failed in the same baudrate.

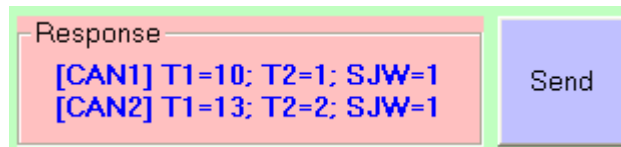

Figure 4-14-4: CAN Baud Bit-Timing Parameters

4.4.3 Extra Config Function

The following is the illustration for “Extra Config” screen like Figure 4-15 and Figure 4-16.

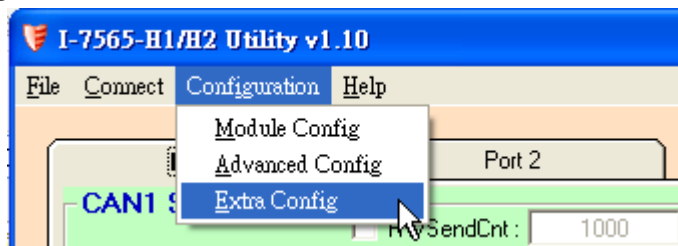

Figure 4-15: Configuration Function of I-7565-H1/H2 Utility

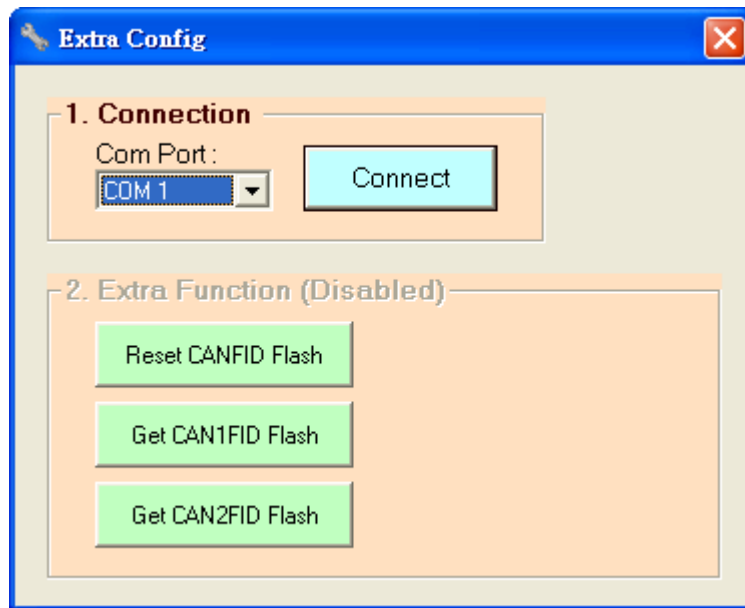

Figure 4-16: Extra Config of I-7565-H1/H2

Please follow the below steps

- (1) Choose the Com Port number and click the “Connect button.
- (2) After connecting to I-7565-H1/H2 successfully, the “Extra Function” will be enabled. The following is the function description.
 - [1] “Reset CANFID Flash” button : **(For Debug)**
=> Clear Filter-ID Flash data of CAN1/2.
 - [2] “Get CAN1FID Flash” button : **(For Debug)**
=> Show the Filter-ID Flash data of CAN1.
 - [3] “Get CAN2FID Flash” button : **(For Debug)**
=> Show the Filter-ID Flash data of CAN2.

4.5 Data Log Function

By clicking “File” item in the menu bar to execute the related data log function. The following is the illustration like Figure 4-15.

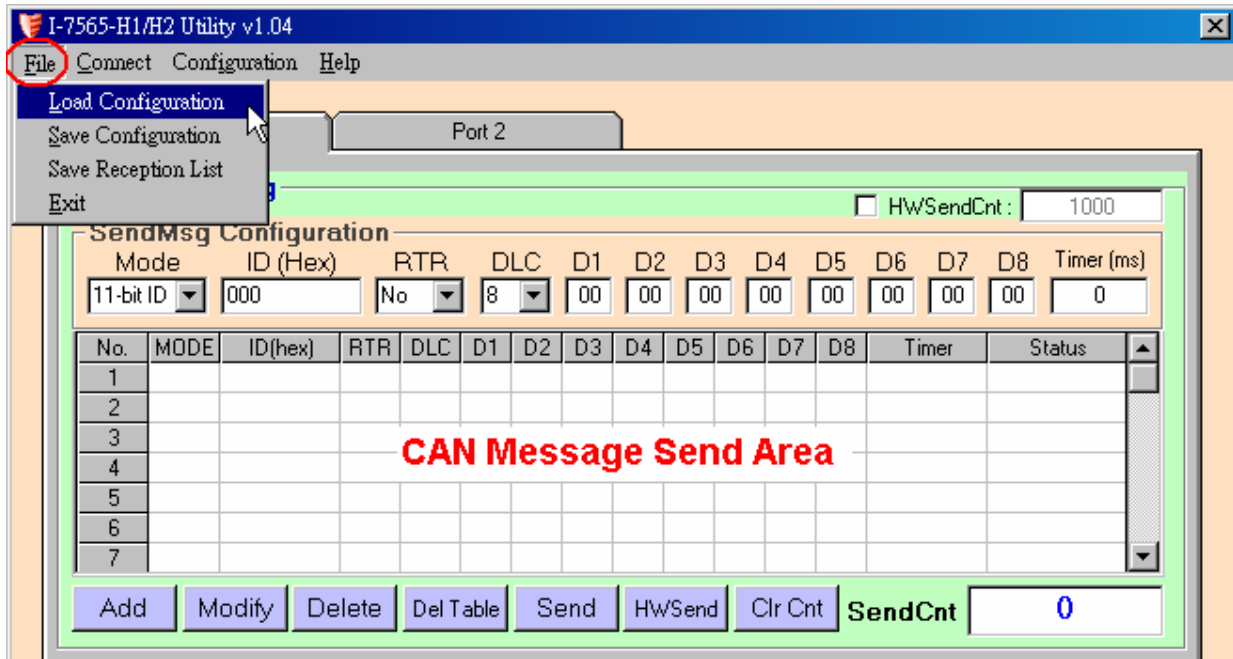

Figure 4-15: Advanced Config of I-7565-H1/H2

<1> **“Load Configuration”** function :

It is used to load the previous “CAN Send Message Configuration” to “CAN Message Send Area” from the assigned “TXT” file like Figure 4-16.

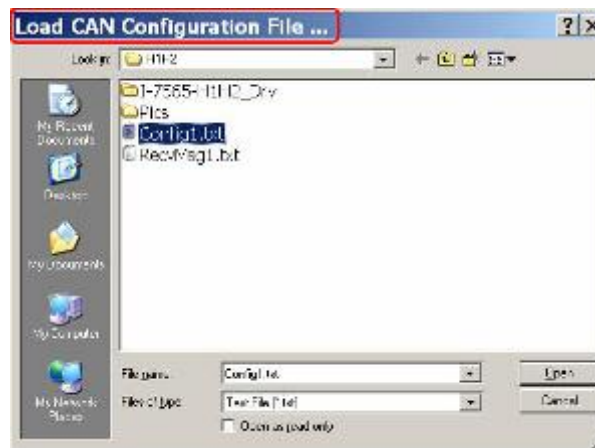

Figure 4-16: Load Configuration

<2> **“Save Configuration”** function :

It is used to save the current “CAN Send Message Configuration” in the “CAN Message Send Area” to the assigned “TXT” file like Figure 4-17.

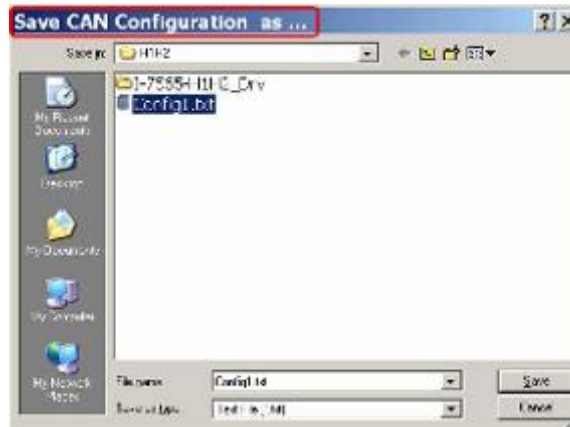

Figure 4-17: Save Configuration

<3> **“Load Reception List”** function :

It is used to load the previous “CAN Receive Message” from the assigned “TXT” file to “CAN Message Receive Area” like Figure 4-17-1.

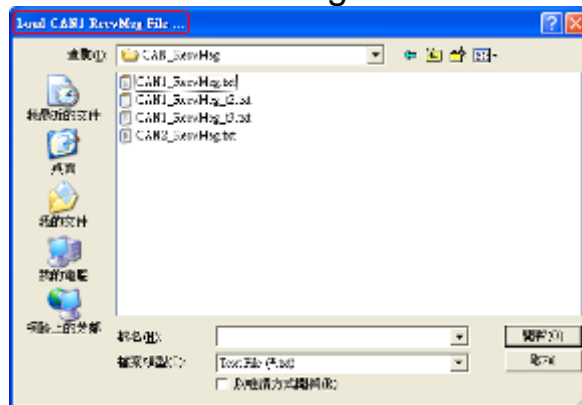

Figure 4-17-1: Load Reception List

<4> **“Save Reception List”** function :

It is used to save the current all CAN received messages in “CAN Message Receive Area” to the assigned “TXT” file as ASCII text like Figure 4-18.

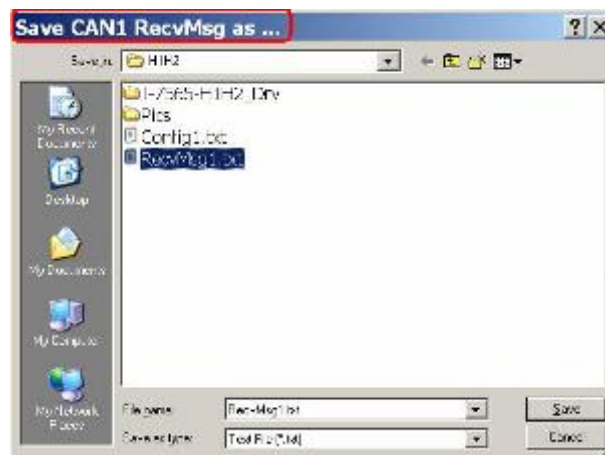

Figure 4-18: Save Reception List

<5> “**Load Symbol File**” function :

It is used to load the Symbolic CANID Name Data from the assigned symbol file (*.ini) to utility like Figure 4-18-1.

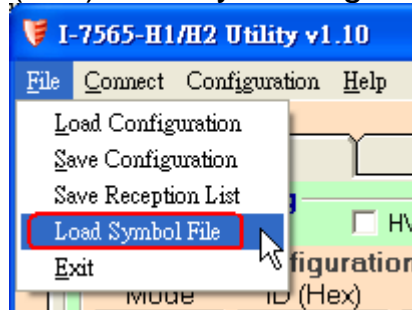

Figure 4-18-1: Load Symbol File

4.6 Status Bar Function

It is used to indicate the current module connection and each CAN port status. The following is detailed illustration for status bar of I-7565-H1/H2 Utility.

If the connection to I-7565-H1/H2 is not built, the status bar information is showed as Figure 4-19.



Figure 4-19: Status Bar of I-7565-H1/H2 Utility for disconnection

When the connection to I-7565-H1/H2 is successful, the status bar information is showed as Figure 4-20 and it can be divided for four blocks.

- (1) **Module Name** => Indicate the connected module name and the virtual com port which is in use.
- (2) **Port Status** => Indicate the CAN port enabled or not.
- (3) **Baud Rate** => Indicate the CAN port baud rate.
- (4) **Company** => ICP DAS Co., LTD

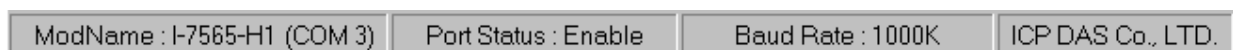

Figure 4-20: Status Bar of I-7565-H1/H2 Utility for disconnection

5. API Library -- VCI_CAN.dll

Users can develop own CAN bus program by I-7565-H1/H2 API library, VCI_CAN.dll, quickly and easily. The VCI_CAN library and demos can be downloaded from the ICP DAS web site :

http://ftp.icpdas.com/pub/cd/fieldbus_cd/can/converter/i-7565-h1h2/software/library.

5.1 API Library Overview

All the functions provided by VCI_CAN library can be separated into five groups shown in Figure 5-1.

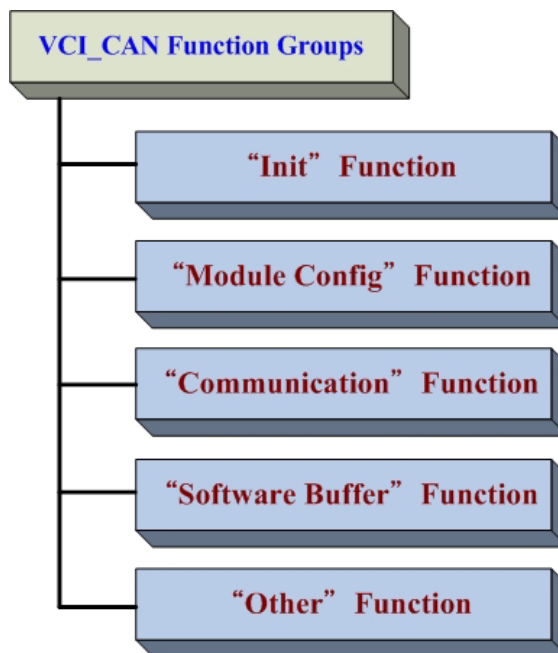

Figure 5-1: Five Function Groups of VCI_CAN Library

[Init Function]

These functions are used to enable / disable CAN port function of I-7565-H1/H2.

[Module Config Function]

These functions are used to set / get the parameters or information of I-7565-H1/H2.

[Communication Function]

These functions are used to send / receive CAN message through I-7565-H1/H2.

[Software Buffer Function]

When “VCI_OpenCAN” function is successful, the received CAN messages will be saved in software buffer provided by VCI_CAN library first and users need to use “VCI_RecvCANMsg” function to get them. The software buffer size is **65536** for each CAN port. These related functions are used to operate the software buffer of VCI_CAN library.

[Other Function]

These functions are used to get the VCI_CAN library information or helpful for users' program.

5.2 API Library Function Table

All the functions provided in the VCI_CAN.dll are listed in the following table.

Table 5-1: “Init” Function Table

No.	Function Name	Description
1	VCI_OpenCAN	Enable CAN port function of I-7565-H1/H2
2	VCI_CloseCAN	Disable CAN port function of I-7565-H1/H2

Table 5-2: “Module Config” Function Table

No.	Function Name	Description
1	VCI_Set_CANFID	Set CAN Filter-ID in the assigned CAN port
2	VCI_Get_CANFID	Get CAN Filter-ID in the assigned CAN port
3	VCI_Get_CANStatus	Get the assigned CAN port status
4	VCI_Clr_BufOverflowLED	Clear buffer overflow ERR LED state in the assigned CAN port
5	VCI_Get_MODInfo	Get the module information
6	VCI_Rst_MOD	Reset module

Table 5-3: “Communication” Function Table

No.	Function Name	Description
1	VCI_SendCANMsg	Send CAN message in the assigned CAN port
2	VCI_RecvCANMsg	Receive CAN message in the assigned CAN port
3	VCI_EnableHWCyclicTxMsg	Send CAN message in the assigned CAN port by using module hardware timer
4	VCI_DisableHWCyclicTxMsg	Stop sending CAN message by module hardware timer

Table 5-4: “Software Buffer” Function Table

No.	Function Name	Description
1	VCI_Get_RxMsgCnt	Get the count of the received CAN messages saved in software buffer that are not received by users’ program in the assigned CAN port
2	VCI_Get_RxMsgBufIsFull	Get the software buffer state whether it is full or not in the assigned CAN port
3	VCI_Clr_RxMsgBuf	Clear the software buffer in the assigned CAN port

Table 5-5: “Other” Function Table

No.	Function Name	Description
1	VCI_Get_DllVer	Get the version of VCI_CAN library.
2	VCI_DoEvents	Release CPU resource temporarily

5.3 Flow Chart for Users' Program Development by Using API

The following is the basic control flow chart of users' CAN bus program development by using API Library – VCI_CAN.dll shown in Figure 5-2.

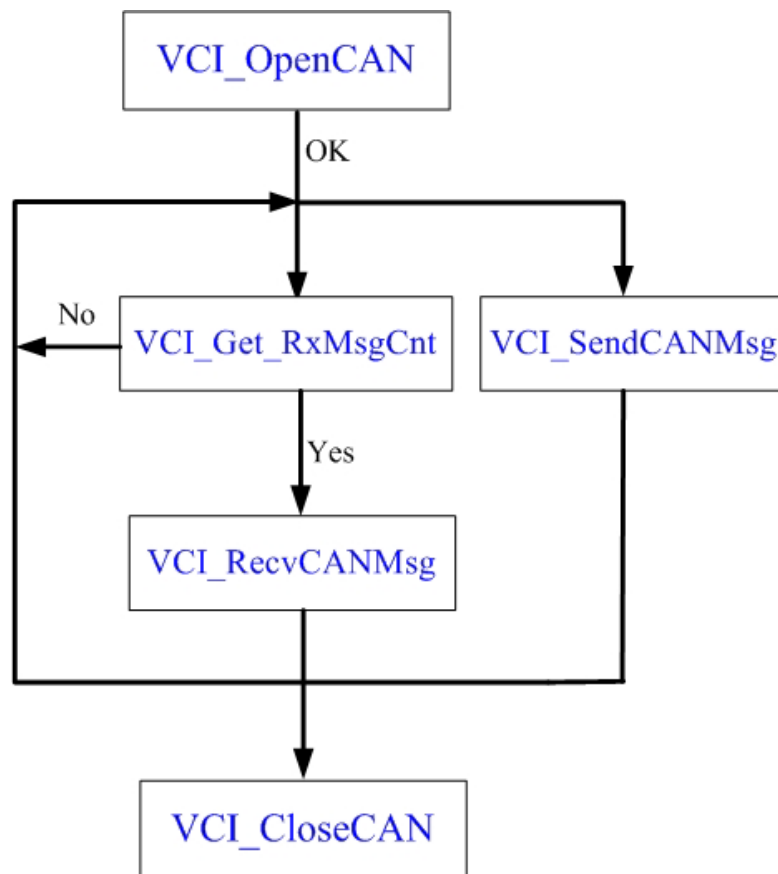

Figure 5-2: Flow Chart of API Library – VCI_CAN.dll

5.4 Init Function

These functions are used to enable / disable CAN port function of I-7565-H1/H2.

5.4.1 VCI_OpenCAN

This function is used to enable the assigned CAN port function of I-7565-H1/H2. After the CAN port function is enabled, users can use “Communication” functions to send / receive CAN messages.

Syntax :

```
int VCI_OpenCAN (  
    PVCI_CAN_PARAM pCANPARAM  
);
```

Parameter :

pCANPARAM:

[in] A structure pointer of _VCI_CAN_PARAM is used to set the CAN port communication parameters shown as below.

```
typedef struct _VCI_CAN_PARAM{  
    BYTE  DevPort;  
    BYTE  DevType;  
    DWORD CAN1_Baud;  
    DWORD CAN2_Baud;  
} _VCI_CAN_PARAM, *PVCI_CAN_PARAM;
```

DevPort : The virtual com port number
DevType : The module type (1: I-7565-H1; 2: I-7565-H2)
CAN1_Baud : CAN1 port baud rate
(0 : Disable CAN1 port
Others: Enable CAN1 port)
CAN2_Baud : CAN2 port baud rate
(0 : Disable CAN2 port
Others: Enable CAN2 port)

Return Values :

Return 0 means success, others means failure.

Examples :

```
Int Ret;  
_VCI_CAN_PARAM pCANPARAM;
```

```
pCANPARAM.DevPort = 1; // Virtual com port = 1
```

```
pCANPARAM.DevType = 1;           // I-7565-H1
pCANPARAM.CAN1_Baud = 250000;    // 250 Kbps
pCANPARAM.CAN2_Baud = 1000000;   // 1000K bps
Ret = VCI_OpenCAN(&pCANPARAM);    // Enable CAN port
```

5.4.2 VCI_CloseCAN

This function is used to disable all CAN port function of I-7565-H1/H2. After the CAN port function is disabled, it will not interfere the communication of CAN bus network even if I-7565-H1/H2 is power on.

Syntax :

```
int VCI_CloseCAN (  
    BYTE DevPort  
);
```

Parameter :

DevPort:
 [in] The virtual com port number

Return Values :

Return 0 means success, others means failure.

Examples :

```
Int Ret;  
BYTE ComPort;  
  
ComPort = 1;  
Ret = VCI_CloseCAN(ComPort);           // Disable CAN port
```

5.5 Module Config Function

These functions are used to set / get the parameters or information of I-7565-H1/H2.

5.5.1 VCI_Set_CANFID

This function is used to set CAN Filter-ID in the assigned CAN port.

Syntax :

```
int VCI_Set_CANFID (  
    BYTE CAN_No,  
    P_VCI_CAN_FID pCANFID  
);
```

Parameter :

CAN_No:

[in] The assigned CAN port number.

pCANFID:

[in] A structure pointer of _VCI_CAN_FilterID is used to set the CAN Filter-ID data shown as below.

```
typedef struct _VCI_CAN_FilterID{  
    WORD SSFF_Num;  
    WORD GSFF_Num;  
    WORD SEFF_Num;  
    WORD GEFF_Num;  
    WORD SSFF_FID[512];  
    DWORD GSFF_FID[512];  
    DWORD SEFF_FID[512];  
    DWORD GEFF_FID[512];  
} _VCI_CAN_FilterID, *P_VCI_CAN_FID;
```

SSFF_Num	: Single 11-bit CAN Filter-ID number
GSFF_Num	: Group 11-bit CAN Filter-ID number
SEFF_Num	: Single 29-bit CAN Filter-ID number
GEFF_Num	: Group 29-bit CAN Filter-ID number
SSFF_FID[512]	: Single 11-bit CAN Filter-ID data array
GSFF_FID[512]	: Group 11-bit CAN Filter-ID data array
SEFF_FID[512]	: Single 29-bit CAN Filter-ID data array
GEFF_FID[512]	: Group 29-bit CAN Filter-ID data array

Return Values :

Return 0 means success, others means failure.

Examples :

```
Int Ret;
BYTE CAN_No;
_VCI_CAN_FilterID pCANFID1;
//Single 11-bit Filter-ID
WORD SSFID[3]={0x0003, 0x0002, 0x0001};
//Group 11-bit Filter-ID
DWORD GSFID[2]={0x00300040, 0x00100020};
//Single 29-bit Filter-ID
DWORD SEFID[3]={0x00000013, 0x00000012, 0x00000011};
//Group 29-bit Filter-ID
DWORD GEFID[4]={0x00000300, 0x00000400, 0x00000100, 0x00000200};

CAN_No=1;
pCANFID1.SSFF_Num = sizeof(SSFID)/sizeof(WORD);
pCANFID1.GSFF_Num = sizeof(GSFID)/sizeof(DWORD);
pCANFID1.SEFF_Num = sizeof(SEFID)/sizeof(DWORD);
pCANFID1.GEFF_Num = sizeof(GEFID)/sizeof(DWORD);
memcpy(pCANFID1.SSFF_FID, SSFID, pCANFID1.SSFF_Num*2);
memcpy(pCANFID1.GSFF_FID, GSFID, pCANFID1.GSFF_Num*4);
memcpy(pCANFID1.SEFF_FID, SEFID, pCANFID1.SEFF_Num*4);
memcpy(pCANFID1.GEFF_FID, GEFID, pCANFID1.GEFF_Num*4);

Ret = VCI_Set_CANFID(CAN_No, &pCANFID1);    // Set CAN Filter-ID
```

5.5.2 VCI_Get_CANFID

This function is used to get CAN Filter-ID in the assigned CAN port.

Syntax :

```
int VCI_Get_CANFID (  
    BYTE CAN_No,  
    PVCI_CAN_FID pCANFID  
);
```

Parameter :

CAN_No:

[in] The assigned CAN port number.

pCANFID:

[out] A structure pointer of _VCI_CAN_FilterID is used to receive the CAN Filter-ID data shown as below.

```
typedef struct _VCI_CAN_FilterID{  
    WORD SSFF_Num;  
    WORD GSFF_Num;  
    WORD SEFF_Num;  
    WORD GEFF_Num;  
    WORD SSFF_FID[512];  
    DWORD  GSFF_FID[512];  
    DWORD  SEFF_FID[512];  
    DWORD  GEFF_FID[512];  
} _VCI_CAN_FilterID, *PVCI_CAN_FID;
```

SSFF_Num	: Single 11-bit CAN Filter-ID number
GSFF_Num	: Group 11-bit CAN Filter-ID number
SEFF_Num	: Single 29-bit CAN Filter-ID number
GEFF_Num	: Group 29-bit CAN Filter-ID number
SSFF_FID[512]	: Single 11-bit CAN Filter-ID data array
GSFF_FID[512]	: Group 11-bit CAN Filter-ID data array
SEFF_FID[512]	: Single 29-bit CAN Filter-ID data array
GEFF_FID[512]	: Group 29-bit CAN Filter-ID data array

Return Values :

Return 0 means success, others means failure.

Examples :

Int Ret;

BYTE CAN_No;

_VCI_CAN_FilterID pCANFID;

WORD SID11_EndNum=0, GID11_EndNum=0;

WORD SID29_EndNum=0, GID29_EndNum=0;

CAN_No=1;

Ret = VCI_Get_CANFID(CAN_No, &pCANFID);

// Get CAN Filter-ID

SID11_EndNum = CANFID.SSFF_Num;

GID11_EndNum = CANFID.GSFF_Num;

SID29_EndNum = CANFID.SEFF_Num;

GID29_EndNum = CANFID.GEFF_Num;

5.5.3 VCI_Get_CANStatus

This function is used to get the assigned CAN port status.

Syntax :

```
int VCI_Get_CANStatus (  
    BYTE CAN_No,  
    P_VCI_CAN_STATUS pCANStatus  
);
```

Parameter :

CAN_No:

[in] The assigned CAN port number.

pCANStatus:

[out] A structure pointer of `_VCI_CAN_STATUS` is used to receive the CAN port status shown as below.

```
typedef struct _VCI_CAN_STATUS{  
    DWORD   CurCANBaud;  
    BYTE   CANReg;  
    BYTE   CANTxErrCnt;  
    BYTE   CANRxErrCnt;  
    BYTE   MODState;  
    DWORD   Reserved;  
} _VCI_CAN_STATUS, *P_VCI_CAN_STATUS;
```

CurCANBaud : Return the assigned CAN port baud rate
CANReg : Return the assigned CAN port register value
CANTxErrCnt : Return the assigned CAN port Tx error count
CANRxErrCnt : Return the assigned CAN port Rx error count
MODState : Return the module state

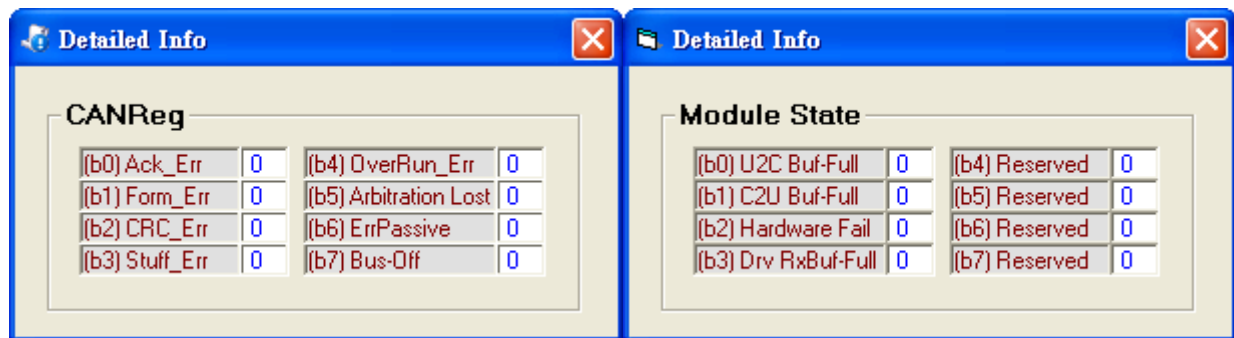

Bit Info of "CANReg"

Bit Info of "MODState"

Return Values :

Return 0 means success, others means failure.

Examples :

```
Int Ret;
```

```
BYTE CAN_No, Module_State;
```

```
_VCI_CAN_STATUS CANSTA;
```

```
CAN_No=1;
```

```
Ret = VCI_Get_CANStatus(CAN_No, &CANSTA); // Get CAN port status
```

```
Module_State = CANSTA.MODState;
```

5.5.4 VCI_Clr_BufOverflowLED

This function is used to clear buffer overflow ERR LED state (flash per second) in the assigned CAN port.

Syntax :

```
int VCI_Clr_BufOverflowLED (  
    BYTE CAN_No,  
);
```

Parameter :

CAN_No:
[in] The assigned CAN port number.

Return Values :

Return 0 means success, others means failure.

Examples :

```
Int Ret;  
BYTE CAN_No;  
  
CAN_No=1;  
Ret = VCI_Clr_BufOverflowLED(CAN_No); // Clear Buffer Overflow LED
```

5.5.5 VCI_Get_MODInfo

This function is used to get module information.

Syntax :

```
int VCI_Get_MODInfo (  
    PVCI_MOD_INFO pMODInfo  
);
```

Parameter :

pMODInfo:

[out] A structure pointer of `_VCI_MODULE_INFO` is used to receive the module information shown as below.

```
typedef struct _VCI_MODULE_INFO{  
    char    Mod_ID[12];  
    char    FW_Ver[12];  
    char    HW_SN[16];  
} _VCI_MODULE_INFO, *PVCI_MOD_INFO;
```

Mod_ID[12] : Return the module name string

FW_Ver[12] : Return the module firmware version string

HW_SN[16] : Return the module hardware serial number string

Return Values :

Return 0 means success, others means failure.

Examples :

```
Int Ret;
```

```
char Module_ID[12], Firmware_Ver[12], Hardware_SN[16];  
_VCI_MODULE_INFO CAN_ModInfo;
```

```
Ret = VCI_Get_MODInfo(&CAN_ModInfo);    // Get module information  
sprintf(Module_ID, "%s", CAN_ModInfo.Mod_ID);  
sprintf(Firmware_Ver, "%s", CAN_ModInfo.FW_Ver);  
sprintf(Hardware_SN, "%s", CAN_ModInfo.HW_SN);
```

5.5.6 VCI_Rst_MOD

This function is used to reset module.

Syntax :

```
int VCI_Rst_MOD (  
    void  
);
```

Parameter :

None

Return Values :

Return 0 means success, others means failure.

Examples :

```
Int Ret;
```

```
Ret = VCI_Rst_MOD(); // Reset Module
```

5.5.7 VCI_Set_MOD_Ex

This extended function is used to set the module parameters of new functions.

Syntax :

```
int VCI_Set_MOD_Ex (  
    BYTE CfgData[512];  
);
```

Parameter :

CfgData[512]:

[in] Module setting parameter array.

[Byte 0] : CAN1 Listen Only Function (0:Disable, 1:Enable)

[Byte 1] : CAN2 Listen Only Function (0:Disable, 1:Enable)

Return Values :

Return 0 means success, others means failure.

Examples :

```
_VCI_CAN_PARAM pCANPARAM;  
BYTE Mod_CfgData[512];
```

```
//Listen Only Mode Setting
```

```
Mod_CfgData[0] = 1; //CAN1 => 0:Disable, 1:Enable
```

```
Mod_CfgData[1] = 0; //CAN2 => 0:Disable, 1:Enable
```

```
VCI_Set_MOD_Ex(Mod_CfgData);
```

```
//Open CAN
```

```
pCANPARAM.DevPort = 1;
```

```
pCANPARAM.DevType = I7565H2;
```

```
pCANPARAM.CAN1_Baud = 1000000;
```

```
pCANPARAM.CAN2_Baud = 1000000;
```

```
Ret = VCI_OpenCAN(&pCANPARAM);
```

5.6 Communication Function

These functions are used to send / receive CAN messages.

5.6.1 VCI_SendCANMsg

This function is used to send CAN messages in the assigned CAN port.

Syntax :

```
int VCI_SendCANMsg (  
    BYTE CAN_No,  
    P_VCI_CAN_MSG pCANMsg  
);
```

Parameter :

CAN_No:

[in] The assigned CAN port number.

pCANMsg:

[in] A structure pointer of _VCI_CAN_MSG is used to set the CAN message parameters shown as below.

```
typedef struct _VCI_CAN_MSG{  
    BYTE Mode;  
    BYTE RTR;  
    BYTE DLC;  
    BYTE Reserved;  
    DWORD ID;  
    DWORD TimeL;  
    DWORD TimeH;  
    BYTE Data[8];  
} _VCI_CAN_MSG, *P_VCI_CAN_MSG;
```

Mode	: CAN message Mode (0: 11-bit; 1: 29-bit)
RTR	: CAN message RTR (0: No RTR; 1: RTR)
DLC	: CAN message Data Length (0~8)
ID	: CAN message ID
TimeL	: CAN message Time-Stamp (Lo-DWORD)
TimeH	: CAN message Time-Stamp (Hi-DWORD)
Data[8]	: CAN message Data Array

Return Values :

Return 0 means success, others means failure.

Examples :

```
Int Ret;
```

```
BYTE CAN_No;
```

```
_VCI_CAN_MSG CAN_SendMsg;
```

```
CAN_No=1;
```

```
CAN_SendMsg.Mode = 1;
```

```
CAN_SendMsg.RTR = 0;
```

```
CAN_SendMsg.ID = 0x1;
```

```
CAN_SendMsg.DLC = 8;
```

```
CAN_SendMsg.Data[0]= 0x12;
```

```
CAN_SendMsg.Data[1]= 0x34;
```

```
CAN_SendMsg.Data[2]= 0x56;
```

```
CAN_SendMsg.Data[3]= 0x78;
```

```
CAN_SendMsg.Data[4]= 0x90;
```

```
CAN_SendMsg.Data[5]= 0xAB;
```

```
CAN_SendMsg.Data[6]= 0xCD;
```

```
CAN_SendMsg.Data[7]= 0xEF;
```

```
Ret = VCI_SendCANMsg(CAN_No, &CAN_SendMsg); // Send CAN Msg
```

5.6.2 VCI_RecvCANMsg

This function is used to receive CAN messages that are saved in software buffer in the assigned CAN port.

Syntax :

```
int VCI_RecvCANMsg (  
    BYTE CAN_No,  
    P_VCI_CAN_MSG pCANMsg  
);
```

Parameter :

CAN_No:

[in] The assigned CAN port number.

pCANMsg:

[out] A structure pointer of `_VCI_CAN_MSG` is used to receive the CAN message shown as below.

```
typedef struct _VCI_CAN_MSG{  
    BYTE Mode;  
    BYTE RTR;  
    BYTE DLC;  
    BYTE Reserved;  
    DWORD ID;  
    DWORD TimeL;  
    DWORD TimeH;  
    BYTE Data[8];  
} _VCI_CAN_MSG, *P_VCI_CAN_MSG;
```

Mode	: CAN message Mode (0: 11-bit; 1: 29-bit)
RTR	: CAN message RTR (0: No RTR; 1: RTR)
DLC	: CAN message Data Length (0~8)
ID	: CAN message ID
TimeL	: CAN message Time-Stamp (Lo-DWORD)
TimeH	: CAN message Time-Stamp (Hi-DWORD)
Data[8]	: CAN message Data Array

Return Values :

Return 0 means success, others means failure.

Examples :

```
Int Ret, i;
BYTE CAN_No;
BYTE CANMsg_Mode, CANMsg_RTR, CANMsg_DLC, CANMsg_Data[8];
DWORD CANMsg_ID, CANMsg;
Double CANMsg_Time;
_VCI_CAN_MSG CAN_RecvMsg;

CAN_No=1;
Ret = VCI_RecvCANMsg(CAN_No, &CAN_RecvMsg); // Recv CAN Msg
CANMsg_Mode = CAN_RecvMsg.Mode;
CANMsg_RTR = CAN_RecvMsg.RTR;
CANMsg_ID = CAN_RecvMsg.ID;
CANMsg_DLC = CAN_RecvMsg.DLC;
CANMsg_Time =
(double)(CAN_RecvMsg.TimeH*pow(2.0,32.0))+((double)CAN_RecvMsg.TimeL/10000));
For(i=0; i< CANMsg_DLC; i++){
    CANMsg_Data[i] = CAN_RecvMsg.Data[i]
}
```

5.6.3 VCI_EnableHWCyclicTxMsg

This function is used to send CAN messages in the assigned CAN port by using module hardware timer and it will be more precise than PC software timer.

In FW v1.05 or newer, five HWSendTimer number (No:0~4) supported. This function will use **HWSendTimer No.0** by default for CAN messages sending.

Syntax :

```
int VCI_EnableHWCyclicTxMsg (  
    BYTE CAN_No,  
    P_VCI_CAN_MSG pCANMsg,  
    DWORD TimePeriod,  
    DWORD TransmitTimes  
);
```

Parameter :

CAN_No:

[in] The assigned CAN port number.

pCANMsg:

[in] A structure pointer of _VCI_CAN_MSG is used to set the CAN message parameters shown as below.

```
typedef struct _VCI_CAN_MSG{  
    BYTE Mode;  
    BYTE RTR;  
    BYTE DLC;  
    BYTE Reserved;  
    DWORD ID;  
    DWORD TimeL;  
    DWORD TimeH;  
    BYTE Data[8];  
} _VCI_CAN_MSG, *P_VCI_CAN_MSG;
```

Mode	: CAN message Mode (0: 11-bit; 1: 29-bit)
RTR	: CAN message RTR (0: No RTR; 1: RTR)
DLC	: CAN message Data Length (0~8)
ID	: CAN message ID
TimeL	: CAN message Time-Stamp (Lo-DWORD)
TimeH	: CAN message Time-Stamp (Hi-DWORD)
Data[8]	: CAN message Data Array

TimePeriod:

[in] The time period of module hardware timer for sending CAN message. If the value is zero, this function doesn't work.

TransmitTimes:

[in] The count for sending CAN message. If the value is zero, it means that CAN message will be sent periodically and permanently.

Return Values :

Return 0 means success, others means failure.

Examples :

Int Ret;

BYTE CAN_No;

_VCI_CAN_MSG CAN_SendMsg;

CAN_No=1;

CAN_SendMsg.Mode = 1;

CAN_SendMsg.RTR = 0;

CAN_SendMsg.ID = 0x1;

CAN_SendMsg.DLC = 8;

CAN_SendMsg.Data[0]= 0x12;

CAN_SendMsg.Data[1]= 0x34;

CAN_SendMsg.Data[2]= 0x56;

CAN_SendMsg.Data[3]= 0x78;

CAN_SendMsg.Data[4]= 0x90;

CAN_SendMsg.Data[5]= 0xAB;

CAN_SendMsg.Data[6]= 0xCD;

CAN_SendMsg.Data[7]= 0xEF;

//Send 200 CANMsg with 10ms period and then stop

Ret = VCI_EnableHWCyclicTxMsg(CAN_No, &CAN_SendMsg, 10, 200);

//Send CANMsg with 10ms period permanently

//Ret = VCI_EnableHWCyclicTxMsg(CAN_No, &CAN_SendMsg, 10, 0);

5.6.4 VCI_DisableHWCyclicTxMsg

This function is used to stop sending CAN messages by module hardware timer (HWSendTimer No.0 by default).

Syntax :

```
int VCI_DisableHWCyclicTxMsg (  
    void  
);
```

Parameter :

None

Return Values :

Return 0 means success, others means failure.

Examples :

```
Int Ret;
```

```
Ret = VCI_DisableHWCyclicTxMsg(); // Disable module hardware timer
```

5.6.5 VCI_EnableHWCyclicTxMsgNo

This function is used to send CAN messages in the assigned CAN port by using module hardware timer and it will be more precise than PC software timer.

In FW v1.05 or newer, five HWSendTimer number (No:0~4) supported. This function can be used to **assign the HWSendTimer No.0~4** for CAN messages sending.

Syntax :

```
int VCI_EnableHWCyclicTxMsgNo (  
    BYTE CAN_No,  
    BYTE Mode,  
    BYTE RTR,  
    BYTE DLC,  
    DWORD ID,  
    BYTE Data[8],  
    DWORD TimePeriod,  
    DWORD TransmitTimes,  
    BYTE HW_TimerNo  
);
```

Parameter :

CAN_No:

[in] The assigned CAN port number.

Mode : [in] CAN message Mode (0: 11-bit; 1: 29-bit)

RTR : [in] CAN message RTR (0: No RTR; 1: RTR)

DLC : [in] CAN message Data Length (0~8)

ID : [in] CAN message ID

Data[8] : [in] CAN message Data Array

TimePeriod:

[in] The time period of module hardware timer for sending CAN message. If the value is zero, this function doesn't work.

TransmitTimes:

[in] The count for sending CAN message. If the value is zero, it means that CAN message will be sent periodically and permanently.

HW_TimerNo:

[in] The assigned HWSendTimer No. (0~4)

Return Values :

Return 0 means success, others means failure.

Examples :

Int Ret;

BYTE CAN_No;

BYTE Mode, RTR, DLC, Data[8], HW_TimerNo;

DWORD ID;

CAN_No =1;

Mode = 1;

RTR = 0;

ID = 0x1;

DLC = 8;

Data[0]= 0x12;

Data[1]= 0x34;

Data[2]= 0x56;

Data[3]= 0x78;

Data[4]= 0x90;

Data[5]= 0xAB;

Data[6]= 0xCD;

Data[7]= 0xEF;

//Send 200 CANMsg with 10ms period and Stop by using HWSendTimer-1

HW_TimerNo = 1;

Ret = VCI_EnableHWCyclicTxMsgNo(CAN_No, Mode, RTR, DLC, ID,
Data, 10, 200, HW_TimerNo);

5.6.6 VCI_EnableHWCyclicTxMsgNo_Ex

This function is used to send CAN messages in the assigned CAN port by using module hardware timer and it will be more precise than PC software timer.

In FW v1.05 or newer, five HWSendTimer number (No:0~4) supported. This function can be used to **assign the HWSendTimer No.0~4** and **adjust CAN Data value** for CAN messages sending.

Syntax :

```
int VCI_EnableHWCyclicTxMsgNo_Ex (  
    BYTE CAN_No,  
    BYTE Mode,  
    BYTE RTR,  
    BYTE DLC,  
    DWORD ID,  
    BYTE Data[8],  
    DWORD TimePeriod,  
    DWORD TransmitTimes,  
    BYTE HW_TimerNo,  
    BYTE AddMode,  
    DWORD DLAddVal,  
    DWORD DHAddVal  
);
```

Parameter :

CAN_No:

[in] The assigned CAN port number.

Mode : [in] CAN message Mode (0: 11-bit; 1: 29-bit)

RTR : [in] CAN message RTR (0: No RTR; 1: RTR)

DLC : [in] CAN message Data Length (0~8)

ID : [in] CAN message ID

Data[8] : [in] CAN message Data Array

TimePeriod:

[in] The time period of module hardware timer for sending CAN message. If the value is zero, this function doesn't work.

TransmitTimes:

[in] The count for sending CAN message. If the value is zero, it means that CAN message will be sent periodically and permanently.

HW_TimerNo:

[in] The assigned HWSendTimer No. (0~4)

AddMode : [in] CAN Data Value Addition Mode (0:Addition; 1:Multiple)

DLAddVal : [in] CANL Data Addition Value every time

DHAddVal : [in] CANH Data Addition Value every time

Return Values :

Return 0 means success, others means failure.

Examples :

Int Ret;

BYTE CAN_No;

BYTE Mode, RTR, DLC, Data[8], HW_TimerNo;

DWORD ID;

CAN_No = 1;

Mode = 1;

RTR = 0;

ID = 0x1;

DLC = 8;

Data[0]= 0x0;

Data[1]= 0x0;

Data[2]= 0x0;

Data[3]= 0x0;

Data[4]= 0x0;

Data[5]= 0x0;

Data[6]= 0x0;

Data[7]= 0x0;

//Send 200 CANMsg with 10ms period and Stop by using HWSendTimer-1

//CANL_Data Value will be added by 1 every time

//CANH_Data Value will be added by 2 every time

HW_TimerNo = 1;

Ret = VCI_EnableHWCyclicTxMsgNo_Ex(CAN_No, Mode, RTR, DLC, ID, Data, 10, 200, HW_TimerNo, ADDITION_MODE, 1, 2);

5.6.7 VCI_DisableHWCyclicTxMsgNo

This function is used to stop sending CAN messages for the assigned HWSendTimer No. 0~4.

Syntax :

```
int VCI_DisableHWCyclicTxMsgNo (  
    BYTE HW_TimerNo  
);
```

Parameter :

HW_TimerNo:

[in] The assigned HWSendTimer No. (0~4)

Return Values :

Return 0 means success, others means failure.

Examples :

```
Int Ret;
```

```
BYTE HW_TimerNo;
```

```
//Stop HWSendTimer-01
```

```
HW_TimerNo = 1;
```

```
Ret = VCI_DisableHWCyclicTxMsgNo(HW_TimerNo);
```

5.7 Software Buffer Function

When users' program receives CAN messages, these received CAN messages will be saved in software buffer provided by VCI_CAN library first and users need to use "VCI_RecvCANMsg" function to get these received CAN messages saved in software buffer. The software buffer size is **65536** for each CAN port.

5.7.1 VCI_Get_RxMsgCnt

This function is used to get the count of these received CAN messages saved in software buffer that are not received by users' program in the assigned CAN port.

Syntax :

```
int VCI_Get_RxMsgCnt (  
    BYTE CAN_No,  
    DWORD* RxMsgCnt  
);
```

Parameter :

CAN_No:

[in] The assigned CAN port number.

RxMsgCnt:

[out] The pointer is used to receive the CAN message count saved in software buffer.

Return Values :

Return 0 means success, others means failure.

Examples :

```
Int Ret;
```

```
BYTE CAN_No;
```

```
DWORD RxMsgCnt;
```

```
CAN_No=1;
```

```
Ret = VCI_Get_RxMsgCnt(CAN_No, &RxMsgCnt); // Recv RxMsg count
```

5.7.2 VCI_Get_RxMsgBufIsFull

This function is used to get the software buffer state whether it is full or not in the assigned CAN port. If the software buffer is full, it means that some CAN messages are lost.

Syntax :

```
int VCI_Get_RxMsgBufIsFull (  
    BYTE CAN_No,  
    BYTE* Flag  
);
```

Parameter :

CAN_No:
[in] The assigned CAN port number.

Flag:

[out] The pointer is used to receive the state of software buffer. If the value is zero, the software buffer is not full. If not, it means that the software buffer is full.

Return Values :

Return 0 means success, others means failure.

Examples :

```
Int Ret;  
BYTE CAN_No;  
BYTE RxSoftBufFull_Flag;
```

```
CAN_No=1;  
Ret = VCI_Get_RxMsgBufIsFull(CAN_No, &RxSoftBufFull_Flag);
```

5.7.3 VCI_Clr_RxMsgBuf

This function is used to clear the receiving software buffer in the assigned CAN port.

Syntax :

```
int VCI_Clr_RxMsgBuf (  
    BYTE CAN_No,  
);
```

Parameter :

CAN_No:
[in] The assigned CAN port number.

Return Values :

Return 0 means success, others means failure.

Examples :

```
Int Ret;  
BYTE CAN_No;  
  
CAN_No=1;  
Ret = VCI_Clr_RxMsgBuf(CAN_No);
```

5.7.4 VCI_Get_TxMsgCnt

This function is used to get the count of CAN messages that needed to be sent in software buffer of the assigned CAN port.

Syntax :

```
int VCI_Get_TxMsgCnt (  
    BYTE CAN_No,  
    DWORD* TxMsgCnt  
);
```

Parameter :

CAN_No:

[in] The assigned CAN port number.

TxMsgCnt:

[out] The pointer is used to get the CAN message count that needed to be sent in software buffer.

Return Values :

Return 0 means success, others means failure.

Examples :

```
Int Ret;
```

```
BYTE CAN_No;
```

```
DWORD TxMsgCnt;
```

```
CAN_No=1;
```

```
Ret = VCI_Get_TxMsgCnt(CAN_No, &TxMsgCnt);
```

5.7.5 VCI_Clr_TxMsgBuf

This function is used to clear the sending software buffer in the assigned CAN port.

Syntax :

```
int VCI_Clr_TxMsgBuf (  
    BYTE CAN_No,  
);
```

Parameter :

CAN_No:
[in] The assigned CAN port number.

Return Values :

Return 0 means success, others means failure.

Examples :

```
Int Ret;  
BYTE CAN_No;
```

```
CAN_No=1;  
Ret = VCI_Clr_TxMsgBuf(CAN_No);
```

5.7.6 VCI_Get_TxSentCnt

This function is used to get the total CAN message count that had been sent in the assigned CAN port.

Syntax :

```
int VCI_Get_TxSentCnt (  
    BYTE CAN_No,  
    DWORD* TxSentCnt  
);
```

Parameter :

CAN_No:

[in] The assigned CAN port number.

TxSentCnt:

[out] The pointer is used to get the total CAN message count that have been sent.

Return Values :

Return 0 means success, others means failure.

Examples :

```
Int Ret;
```

```
BYTE CAN_No;
```

```
DWORD TxSentCnt;
```

```
CAN_No=1;
```

```
Ret = VCI_Get_TxSentCnt(CAN_No, &TxSentCnt);
```

5.7.7 VCI_Clr_TxSentCnt

This function is used to clear the total CAN message count that had been sent in the assigned CAN port.

Syntax :

```
int VCI_Clr_TxSentCnt (  
    BYTE CAN_No,  
);
```

Parameter :

CAN_No:
[in] The assigned CAN port number.

Return Values :

Return 0 means success, others means failure.

Examples :

```
Int Ret;  
BYTE CAN_No;
```

```
CAN_No=1;  
Ret = VCI_Clr_TxSentCnt(CAN_No);
```

5.8 User Defined ISR Function

These functions are used to execute user-defined function when receiving the assigned CAN-ID message.

5.8.1 VCI_Set_UserDefISR

This function is used to set the user-defined callback ISR function and the assigned port number, mode and ID of the received CAN message. When receiving the CAN message which is matched with the assigned port number, mode and ID, the corresponding user-defined function will be executed once right now.

Syntax :

```
int VCI_Set_UserDefISR (  
    BYTE ISRNo,  
    BYTE CAN_No,  
    BYTE Mode,  
    DWORD CANID,  
    void (*UserDefISR)()  
);
```

Parameter :

ISRNo:

[in] The assigned ISR No. (Valid: 0 ~ 7)

CAN_No:

[in] The assigned CAN port number. (0: for all CAN port)

Mode:

[in] The assigned CAN message Mode (2: for all CAN Mode).

CANID:

[in] The assigned CAN message ID. (0: for all CAN-ID)

*UserDefISR:

[in] The assigned user-defined function pointer.

Return Values :

Return 0 means success, others means failure.

Examples :

Int Ret;

```
/* The UserDefISR (MyTestISR0) will be triggered when receiving any one CANMsg */  
Ret=VCI_Set_UserDefISR(ISRNO_0,  ISR_CANPORT_ALL,  ISR_CANMODE_ALL,  
ISR_CANID_ALL, MyTestISR0);
```

```
/* The UserDefISR (MyTestISR1) will be triggered when only CAN1 receiving 11-bit  
CANMsg with CANID=0x100 */  
Ret=VCI_Set_UserDefISR(ISRNO_1, CAN1, MODE_11BIT, 0x100, MyTestISR1);
```

[Note]

1. The code of the user-defined callback function should be the more simple the better (means the execution time the shorter the better) and the frequency of the matched CAN message should be the slower the better. Or it could cause the execution count lost of user-defined function.

5.8.2 VCI_Clr_UserDefISR

This function is used to disable the user-defined ISR function.

Syntax :

```
int VCI_Clr_UserDefISR (  
    BYTE ISRNo,  
);
```

Parameter :

ISRNo:

[in] The assigned ISR No. (Valid: 0 ~ 7)

Return Values :

Return 0 means success, others means failure.

Examples :

```
/* Disable UserDefFunction of ISRNO_0 and ISRNO_1 */  
VCI_Clr_UserDefISR(ISRNO_0);  
VCI_Clr_UserDefISR(ISRNO_1);
```

5.8.3 VCI_Get_ISRCANData

This function is used to get the CAN message data when user-defined ISR function is triggered.

Syntax :

```
int VCI_Get_ISRCANData (  
    BYTE ISRNo,  
    BYTE* DLC,  
    BYTE Data[8],  
);
```

Parameter :

ISRNo:

[in] The assigned ISR No. (Valid: 0 ~ 7)

DLC:

[out] The pointer is used to receive the CAN message data length.

Data:

[out] The data buffer is used to receive the CAN message data.

Return Values :

Return 0 means success, others means failure.

Examples :

```
BYTE ISR1_CANDataLen;  
BYTE ISR1_CANData[8]={0};
```

```
VCI_Get_ISRCANData(ISRNO_1, &ISR1_CANDataLen, ISR1_CANData);
```

5.9 Other Function

These functions are used to get the VCI_CAN library information or helpful for users' program.

5.9.1 VCI_Get_DIIVer

This function is used to get the version of VCI_CAN library.

Syntax :

```
DWORD VCI_Get_DIIVer (  
    void  
);
```

Parameter :

None

Return Values :

Return the VCI_CAN library version. Hi-byte is the major version and lo-byte is the minor version.

Examples :

```
DWORD DIIVer;  
char VCI_DIIVer[10];
```

```
DIIVer = VCI_Get_DIIVer();  
sprintf(VCI_DIIVer, "v%lu.%02lu", (DIIVer>>8)&0xFF, DIIVer&0xFF);
```

5.9.2 VCI_DoEvents

This function is used to release CPU resource temporarily.

Syntax :

```
void VCI_DoEvents (  
    void  
);
```

Parameter :

None

Return Values :

None

Examples :

```
VCI_DoEvents() ;
```

5.10 Extended Function

These functions are used to extend the other functions of I-7565-H1/H2.

5.10.1 VCI_OpenCAN_Ex

This function is the same with the VCI_OpenCAN() but it adds the function able to adjust the sample point (Tseg2 value) of bit-timing of CAN baud. It is useful when CAN bus communication failed in the occasion filled with electromagnetic interference (such as: motor starts causing interference), then users can use the bigger Tseg2 value in the same baudrate for CAN bus communication.

Syntax :

```
int VCI_OpenCAN_Ex (
    PVCI_CAN_PARAM_EX pCANPARAMEx
);
```

Parameter :

pCANPARAM:

[in] A structure pointer of _VCI_CAN_PARAM_EX is used to set the CAN port communication parameters and Tseg2 value shown as below.

```
typedef struct _VCI_CAN_PARAM_EX{
    BYTE  DevPort;
    BYTE  DevType;
    DWORD CAN1_Baud;
    DWORD CAN2_Baud;
    BYTE  CAN1_T2Val;
    BYTE  CAN2_T2Val;
    BYTE  Reserved[32];
} _VCI_CAN_PARAM_EX, *PVCI_CAN_PARAM_EX;
```

DevPort	: The virtual com port number
DevType	: The module type (1: I-7565-H1; 2: I-7565-H2)
CAN1_Baud	: CAN1 port baud rate (0 : Disable CAN1 port Others: Enable CAN1 port)
CAN2_Baud	: CAN2 port baud rate (0 : Disable CAN2 port Others: Enable CAN2 port)

CAN1_T2Val : The Tseg2 value of CAN1
CAN2_T2Val : The Tseg2 value of CAN2
Reserved[32] : Reserved

Return Values :

Return 0 means success, others means failure.

Examples :

```
Int Ret;  
_VCI_CAN_PARAM_EX pCANPARAM;  
  
pCANPARAM.DevPort = 1;           // Virtual com port = 1  
pCANPARAM.DevType = 1;          // I-7565-H1  
pCANPARAM.CAN1_Baud = 250000;   // 250 Kbps  
pCANPARAM.CAN2_Baud = 1000000;  // 1000K bps  
pCANPARAM.CAN1_T2Val = 2;       // CAN1 Tseg2 = 2  
pCANPARAM.CAN2_T2Val = 3;       // CAN2 Tseg2 = 3  
Ret = VCI_OpenCAN_Ex(&pCANPARAM); // Enable CAN port
```

5.10.2 VCI_Get_CANBaud_BitTime

This function is used to get the Tseg1, Tseg2 and SJW values of the CAN baud bit-timing parameters of the assigned CAN port. [When the CAN communication failed, it can be used to check if the bit-timing parameters of the other CAN devices are the same with I-7565-H1/H2 module.](#)

Syntax :

```
int VCI_Get_CANBaud_BitTime (  
    BYTE CAN_No,  
    BYTE* T1Val,  
    BYTE* T2Val,  
    BYTE* SJWVal  
);
```

Parameter :

CAN_No:

[in] The assigned CAN port number.

T1Val:

[out] The pointer is used to receive the Tseg1 value of the assigned CAN port.

T2Val:

[out] The pointer is used to receive the Tseg2 value of the assigned CAN port.

SJWVal:

[out] The pointer is used to receive the SJW value of the assigned CAN port.

Return Values :

Return 0 means success, others means failure.

Examples :

```
int Ret;
```

```
BYTE CAN_No;
```

```
BYTE T1Val=0, T2Val=0, SJWVal=0;
```

```
CAN_No=1;
```

```
Ret = VCI_Get_CANBaud_BitTime (CAN_No, &T1Val, &T2Val, &SJWVal);
```

5.11 Return Code

The return value is used to show the result of executing VCI_CAN library functions. The following is the all return codes.

Error Code	Error ID	Error String
0	No_Err	OK (No Error)
1	DEV_ModName_Err	The module name is error
2	DEV_ModNotExist_Err	The module doesn't exist in this port
3	DEV_PortNotExist_Err	The port doesn't exist
4	DEV_PortInUse_Err	The port is in use
5	DEV_PortNotOpen_Err	The port doesn't open
6	CAN_ConfigFail_Err	CAN ConfigCmd Fail
7	CAN_HARDWARE_Err	CAN hardware init Fail
8	CAN_PortNo_Err	The device doesn't support this CAN port
9	CAN_FIDLength_Err	The CAN filter-ID number exceeds the max number
10	CAN_DevDisconnect_Err	The device is disconnected.
11	CAN_TimeOut_Err	The ConfigCmd is timeout
12	CAN_ConfigCmd_Err	The ConfigCmd doesn't support
13	CAN_ConfigBusy_Err	The ConfigCmd is busy
14	CAN_RxBufEmpty	The CAN receive buffer is empty
15	CAN_TxBufFull	The CAN send buffer is full
16	CAN_UserDefISRNo_Err	The User Defined ISRNo. Error
17	CAN_HWSendTimerNo_Err	The HW SendTimer No. Error

6. API Library -- mVCI_CAN.dll

The mVCI_CAN library is used to control **multi-modules of I-7565-H1/H2** simultaneously in the same program. The below picture is the structure of I-7565-H1/H2 library :

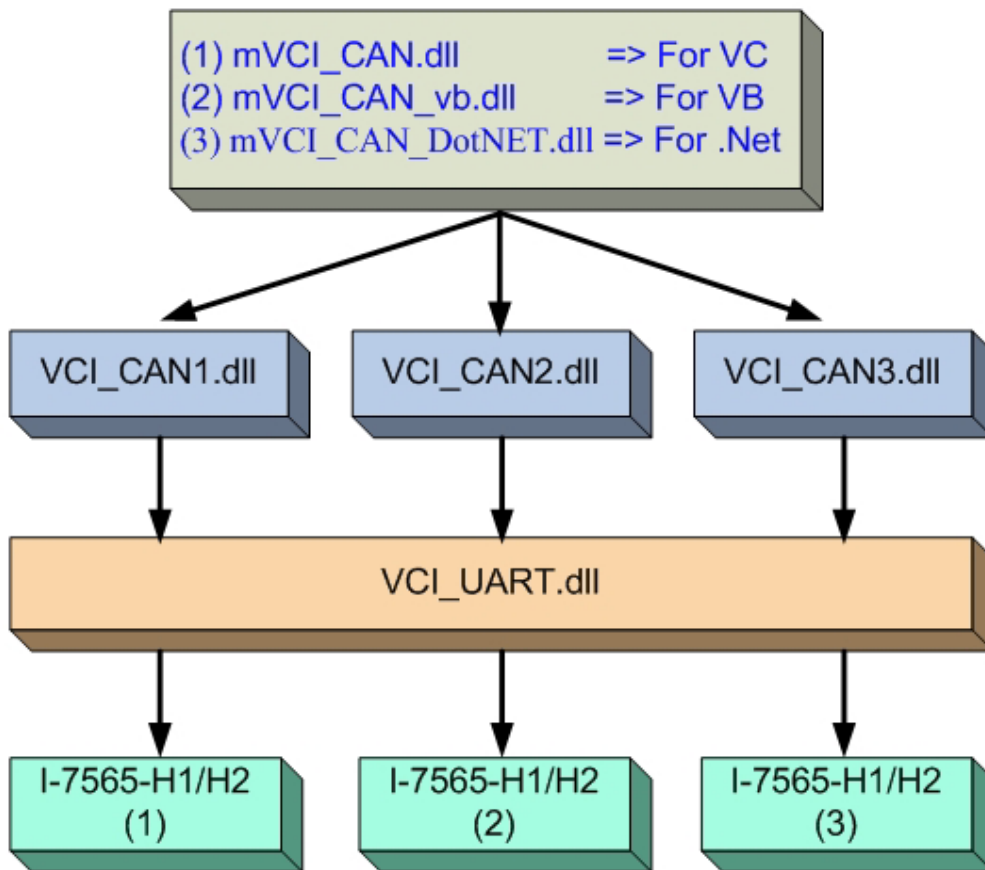

Structure of I-7565-H1/H2 Library

It adopts the Object-Oriented Program (OOP) concept and every object built means one I-7565-H1/H2 module. The following are basic steps for usage of mVCI_CAN library to control multi-modules of I-7565-H1/H2.

6.1 For VC Project

(1) Necessary Files for VC project :

-
- [1] Copy "**mVCI_CAN.h**" and "**mVCI_CAN.lib**" files in VC project folder.
(Without using VCI_CAN.h and VCI_CAN.lib)
 - [2] Copy these three files - "**mVCI_CAN.dll**", "**VCI_CAN.dll**" and "**VCI_Uart.dll**" to Debug or Release folder of VC project.

(2) Program for VC project :

- [1] Include "mVCI_CAN.h" and "mVCI_CAN.lib" to VC project.
- [2] Declare global objects of "CMVCI_CAN" class defined in mVCI_CAN.h.
(Like: CMVCI_CAN I7565H1H2_Mod[2];)
- [3] Execute InitDLL() function for every object of "CMVCI_CAN" class.
(Like: I7565H1H2_Mod[0].InitDLL();)
- [4] After InitDLL() function executes successfully, every object will be one I-7565-H1/H2 module. Then users can use object to operate I-7565-H1/H2 module.
(Like: I7565H1H2_Mod[0].mVCI_OpenCAN();)
- [5] Please refer to the VC demo3 of I-7565-H1/H2 for details.

6.2 For VB Project

(1) Necessary Files for VC project :

- [1] Copy these five files - "**mVCI_CAN_vb_Register.bat**", "**mVCI_CAN_vb.dll**", "**VCI_CAN.dll**", "**VCI_UART.dll**" and "**I-7565-H1H2_Lib.bas**" to VB project folder.
- [2] Execute "mVCI_CAN_vb_Register.bat" file to register "mVCI_CAN_vb.dll" information to Windows system.

(2) Program for VB project :

- [1] Add "mVCI_CAN_vb" reference to VB project by following below steps :
 - (1) Click "Project/References..." option.
 - (2) Click "Browser..." button and choose "mVCI_CAN_vb.dll" file.
Then "mVCI_CAN_vb" reference will be added to VB

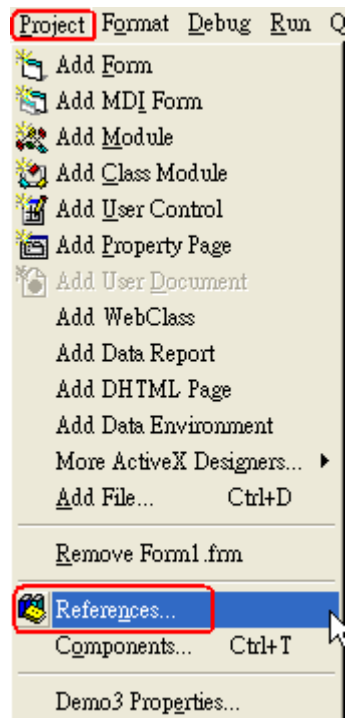

"Project/References..." option

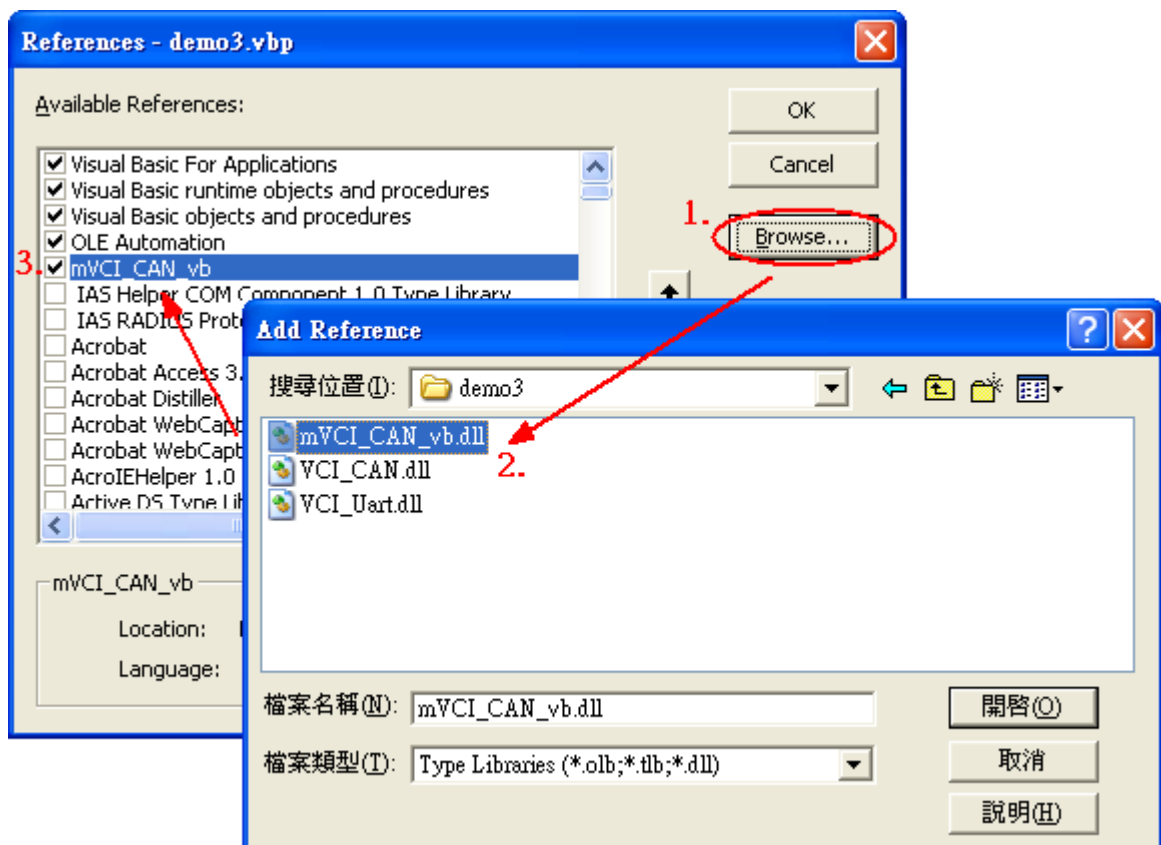

"mVCI_CAN_vb" reference

[2] Declare two global variable of "CMVCI_CAN" class.
 (Like: Private I7565H1H2_Mod(1) As CMVCI_CAN)

-
- [3] Create every object of "MVCI_SDK" class and execute InitDLL() function.
(Like: Set I7565H1H2_Mod(0) = New CMVCI_CAN
I7565H1H2_Mod(0).InitDL())
 - [4] After InitDLL() function executes successfully, every object will be one I-7565-H1 or I-7565-H2 module. Then users can use object to operate I-7565-H1/H2 module.
(Like: I7565H1H2_Mod(0).mVCI_OpenCAN())
 - [5] Please refer to the VB demo3 of I-7565-H1/H2 for details.

6.3 For .Net Project

(1) Necessary Files for .Net project :

- [1] Copy these files - "**mVCI_CAN_DotNET.dll**", "**VCI_CAN.dll**" and "**VCI_Uart.dll**" to Debug or Release folder of .Net project.

(2) Program for .Net project :

- [1] Add "**mVCI_CAN_DotNET.dll**" file to reference of .Net project.
- [2] Type "**using mVCI_CAN_DotNET;**" in the head of .Net project
- [3] Declare global variable of "MVCI_SDK" class.
(Like: MVCI_SDK[] I7565H1H2_Mod = new MVCI_SDK[2];)
- [4] Create every object of "MVCI_SDK" class and execute InitDLL() function.
(Like: I7565H1H2_Mod[0] = New MVCI_SDK();
I7565H1H2_Mod[0].InitDLL();)
- [5] After InitDLL() function executes successfully, every object will be one I-7565-H1 or I-7565-H2 module. Then users can use object to operate I-7565-H1/H2 module.
(Like: I7565H1H2_Mod[0].mVCI_OpenCAN_NoStruct();)
- [6] Please refer to the .Net demo2 of I-7565-H1/H2 for details.

7. Troubleshooting

7.1 The Connection Issue

If the driver installation of I-7565-H1/H2 is successful, the virtual com port will be assigned by Windows automatically. Then users can use “I-7565-H1/H2 Utility” to connect to I-7565-H1/H2 module via the virtual com port for CAN bus communication.

Q1 : ”Invalid port number” error message ?

When users open the virtual com port, if it shows the ”Invalid port number” error message like Figure 7.1-1, Please follow the below steps to solve this problem.

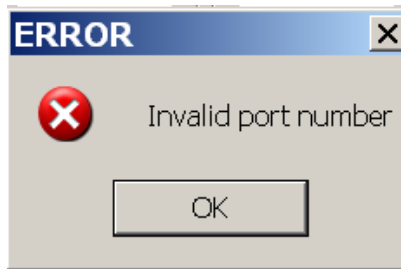

Figure 7.1-1: Invalid port number

- (1) This com port is not existed in system and please check the com port number again.
- (2) If the virtual com port number is bigger than COM16, then users need to copy the new version “**MSCOMM32.OCX**” file in I-7565-H1H2 utility folder to “C:\WINDOWS\system32\” folder to replace the old version file and then register “MSCOMM32.ocx” file again.
- (3) There are other devices using the same com port number with I-7565-H1/H2 module. Please modify the com port number in “Device Manager” and then reboot PC. After that, reconnect to I-7565-H1/H2 module again. [Users can execute “Show_Hidden_Device.bat” file in the I-7565-H1/H2 utility folder to open “Device Manager” tool and click “View / Show hidden devices” option. Then in “Ports \(COM & LPT\) item, it will show all com port of system like Figure 7.1-1-1.](#)

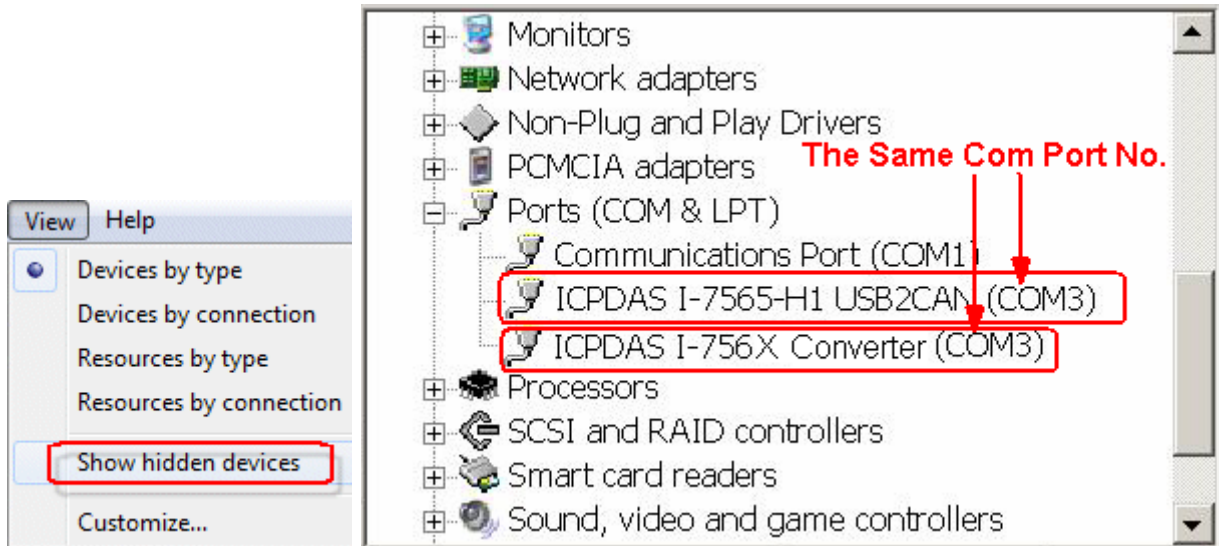

Figure 7.1-1-1: Show_hidden_devices

If it still failed, please check that the driver installation is completed or the virtual com port is correct for I-7565-H1/H2.

Q2 : "The device is not open" error message ?

When users open the virtual com port, if it shows the "The device is not open" error message like Figure 7.1-2, it means that the com port is occupied by other program like ICP DAS VxComm Utility. Please "UnMap" the same com port used in VxComm Utility and then click "Restart Driver" function like Figure 7.1-3. After that, reset I-7565-H1/H2 and try to connect to I-7565-H1/H2 again.



Figure 7.1-2: The device is not open

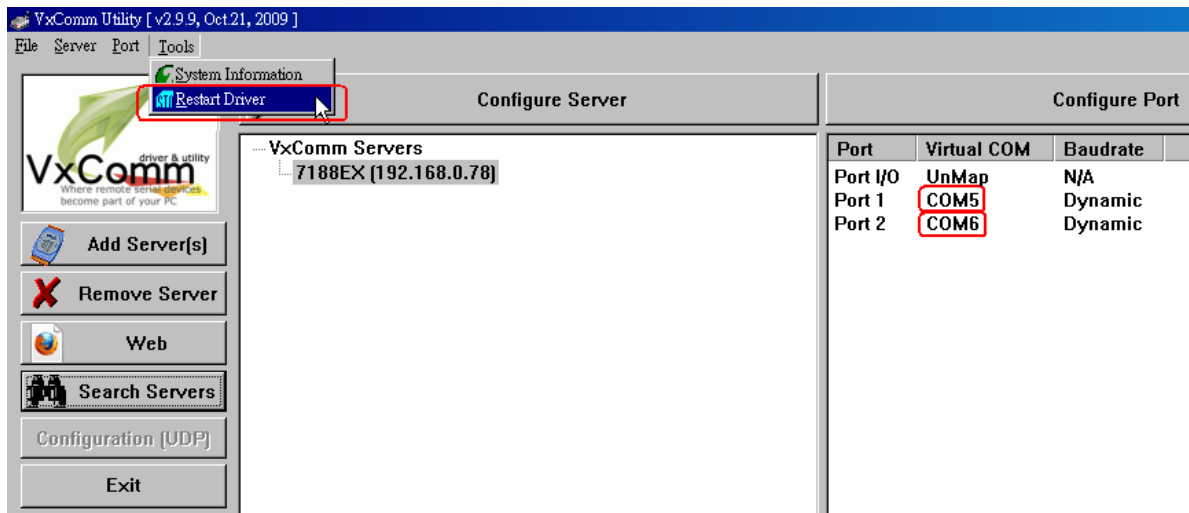

Figure 7.1-3: Virtual COM of VxComm Utility

Q3 : "Device doesn't Exist" error message ?

When users open the virtual com port, if it shows the "Device doesn't Exist !! Please Check Port No. !!" error message like Figure 7.1-4, it means that the com port is occupied by other program. Please modify the com port number in "Device Manager" and then reboot PC. After that, reconnect to I-7565-H1/H2 module again.



Figure 7.1-4: Device doesn't Exist

Q4 : "Could not set comm state" error message ?

When connecting to I-7565-H1/H2 via I-7565-H1/H2_Utility, it shows the "Could not set comm state" error message like Fig 7.1-5. Please execute the "Reset CANFID Flash" function in "Extra Config" function screen (refer to section 4.4.3) to clear the Filter-ID Flash data of CAN1/2. Then the problem will be resolved. Note, please check the

I-7565-H1/H2 firmware version is v1.06 or newer and utility version is v1.10 or newer to support the “Reset CANFID Flash” function.

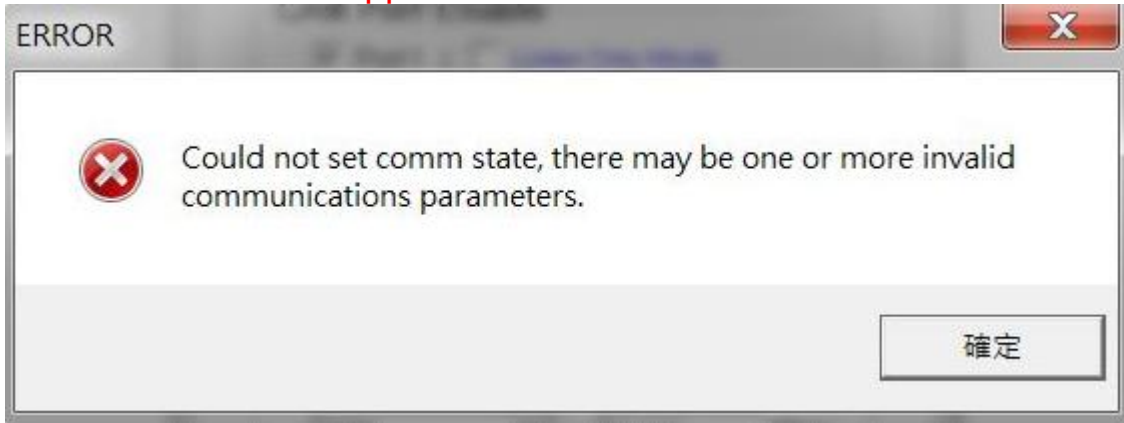

Fig 7.1-5 “Could not set comm state” Error Message

7.2 The CAN Baud Rate Issue

(1) The CAN baud rate mismatch:

If the I-7565-H1/H2 CAN baud rate is not the same as the CAN baud rate on the CAN bus network, the RUN LED on the I-7565-H1/H2 will flash per 100ms because the I-7565-H1/H2 cannot send any CAN message to the CAN bus network. Users can get the CAN status of I-7565-H1/H2 by using “I-7565-H1/H2 Utility” to help users understand what is going in the module.

(2) The user-defined CAN baud rate setting:

If users want to use the user-defined CAN baud rate, in the “Connect to I-7565-H1/H2” screen of “I-7565-H1/H2 Utility”, users can choose the “**Defined**” item and input the user-defined CAN baud rate value (for example: 83.333) in the right field of the “Baud Rate” frame like Figure 7.2-1. Then click “Connect” button to connect to I-7565-H1/H2.

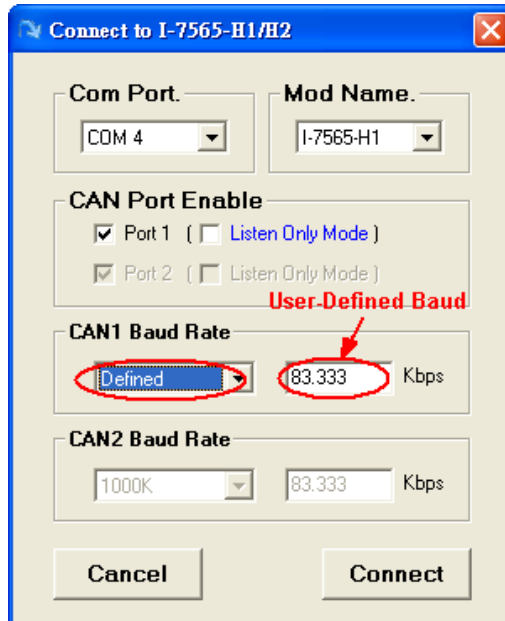

Figure 7.2-1: User-defined CAN Baud Rate for I-7565-H1/H2

(3) The rule of user-defined CAN baud rate setting in the SJA1000 CAN devices for communication compatible with I-7565-H1/H2:

If users use I-7565-H1/H2 to communicate with SJA1000 CAN devices and CAN baud rate is user-defined CAN baud rate. Then in SJA1000 CAN devices, users need to choose a set of proper CAN parameter (**BTR0** & **BTR1**) for communication compatible with I-7565-H1/H2 and the rule is as follows:

- (1) The “**Samples**” value is 1.
- (1) The “**SJW**” value is as small as possible. (1 is the best).
- (2) The “**Tseg2**” value is as small as possible. (1 is the best)
- (3) The “**Tseg1**” value is as large as possible.

According to the above four rules, users can choose the proper BTR0 and BTR0. For example, if uses want to use the CAN baud rate is 83.333 Kbps, according to the above rules, users should choose BTR0=05 and BTR1=1C for the CAN parameter of SJA1000 CAN devices like Figure 7.2-2.

BTR0(hex)	BTR1(hex)	Samples	Spl%	TSEG1	TSEG2	BRP	SJW	Max.Bus(m)	Kbps	Disc.Tol(%)
0F	12	1	66	3	2	16	1	516	83.3333	.2809
0B	14	1	75	5	2	12	1	652	83.3333	.2101
07	18	1	83	9	2	8	1	788	83.3333	.1397
05	1C	1	87	13	2	6	1	856	83.3333	.1046
0B	23	1	62	4	3	12	1	516	83.3333	.211
4B	23	1	62	4	3	12	2	379	83.3333	.4219
07	27	1	75	8	3	8	1	697	83.3333	.1401
47	27	1	75	8	3	8	2	606	83.3333	.2801
0F	2B	1	91	13	2	6	1	700	83.3333	.1040

Figure 7.2-2: User-defined CAN Baud Rate for SJA1000 Device

7.3 The Same CAN-ID Conflict Issue

If the same CAN-ID conflict condition in CAN bus network happened frequently, it may cause CAN bus communication failed in I-7565-H1/H2 module. Users should solve the CAN-ID conflict condition and reset I-7565-H1/H2 module for the later CAN bus communication.

7.4 The PC Rebooting Issue

If using I-7565-H1/H2 for a while, the PC reboots automatically. Please update the newest "Service Pack of Windows" to your PC platform. For example, if users use Windows XP, please update the service pack to SP3 or newer version to solve this problem.

7.5 The Max Data Transfer Rate (fps) Issue

The max CAN bus data transfer rate in I-7565-H1/H2 is up to 3000 fps and it can be adjusted by I-7565-H1/H2 Utility. If users' PC performance is not good enough, the data loss condition may happen. In this time, users can use "Advanced Config" function to adjust hardware transfer rate of "CAN to USB" in I-7565-H1/H2 and it may improve the data loss problem. Remember that hardware data transfer rate can not be lower than the current CAN bus flow, or the data loss will happen in I-7565-H1/H2 module.

7.6 The Data Loss Issue

There are two possible causes for the data loss problem. They are described as follows:

(1) **Software receiving buffer provided by API library overflow.**

It means that the users' program could not receive the CAN messages from software buffer in time. Therefore, users should optimize the communication strategy.

(2) **Hardware receiving buffer overflow.**

A large delay of the interrupt happened in the receiving-end PC and it can be solved by enhancing the PC hardware performance

or properly slowing down the transmitting speed for the other CAN bus nodes.

7.7 The Module Number Applied to One PC Issue

In theory, there is no the limitation. It supports synchronous operation in a PC with more than one I-7565-H1/H2 modules but the total communication efficiency depends on the PC hardware performance.

7.8 The Long Driver Installation Time Issue

If users install the driver of I-7565-H1/H2 followed by the steps of chapter 3 and it takes more than 2 minutes, please follow the below steps to solve this problem.

- (1) Copy “**I-7565-H1H2.inf**” file to C:\WINDOWS\inf\ folder.
- (2) Copy the file, “**usbser.sys**”, to the path:
C:\WINDOWS\system32\drivers\.
- (3) Please follow the steps in chapter 3 to install the I-7565-H1/H2 driver by manual again. In the below step like Figure 7.8-1, please choose “Don’t search. I will choose the driver to install” option and then click “Next” button.



Figure 7.8-1: Driver Installation of I-7565-H1/H2 (1)

(4) When the Figure 7.8-2 shows, click “Next” button and the other steps are the same with those in chapter 3.

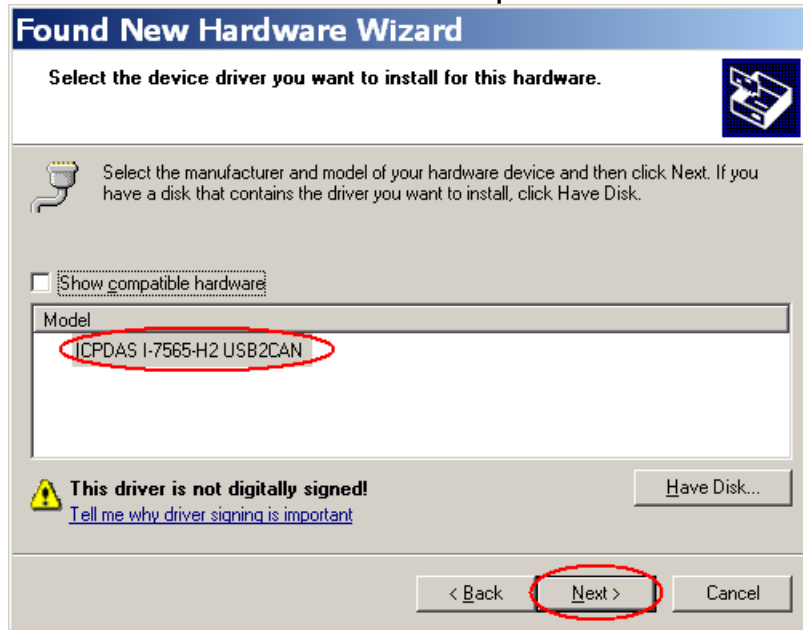

Figure 7.8-2: Driver Installation of I-7565-H1/H2 (2)

7.9 The Supported CAN Filter-ID Number Issue

The total capacity for CAN Filter-ID provided by I-7565-H1/H2 is 440 WORD. The following table describes the size of every different type CAN Filter-ID.

	Size (Unit: WORD)
11-bit Single ID	1
11-bit Group ID	2
29-bit Single ID	2
29-bit Group ID	4

Table 7.9-1: Size of Every Different Type CAN Filter-ID

According to the Table 7.9-1, the following table describes the supported CAN Filter-ID number of I-7565-H1/H2.

	I-7565-H1 (CAN Port)	I-7565-H2 (Each CAN Port)

11-bit Single ID	440/1 = 440	220
11-bit Group ID	440/2 = 220	110
29-bit Single ID	440/2 = 220	110
29-bit Group ID	440/4 = 110	55

Table 7.9-2: size of every different type CAN ID

7.10 Other Issue

In general, the following errors could also occur. For example, CAN media connection problem, terminal resistor problem, different baud rate configuration with CAN network and so on.

7.11 Windows 7 Issues

7.11.1 In Windows 7 64-bit (x64) OS, how to install I-7565-H1/H2 Driver and run I-7565-H1/H2 Utility correctly ?

(1) In Windows 7 64-bit (x64) OS, users must install I-7565-H1/H2 driver by manual. Please follow the below steps :

[1] Execute "ICPUsbConverter_DrvInst_v1.2.exe" (**driver signature certificate is supported in v1.2 or newer**) to install necessary files to "C:\WINDOWS\inf".

[2] Connect I-7565-H1/H2 module to PC and follow the below steps (Or steps in the chapter 3.2) to install driver by manual.

<1> Decompress the "I-7565-H1H2_DrvFile_v1.4.rar" file.

<2> Copy the "I-7565-H1H2_DrvFile_v1.4" folder to the desktop.

<3> Install I-7565-H1/H2 driver by using manual method.

[\(Important: Driver File => choose the "I-7565-H1H2_DrvFile_v1.4" folder in the desktop\)](#)

(2) After driver installation successfully, if without driver signature certificate, there will be an "!" icon on I-7565-H1/H2 Virtual COM driver like Fig 7.11-1. If users install I-7565-H1/H2 driver version older than v1.2, then this problem will happen. Please uninstall driver first, then install the v1.2 or newer driver again. After that, the I-7565-H1/H2 driver will work well like Fig 7.11-2.

(3) When execute “I-7565-H1/H2 Utility” first, remember to execute it by “System Administrator” authority like Fig 7.11-3. Or there will be an error message – “Component not correctly registered” shown like Fig 7.11-4.

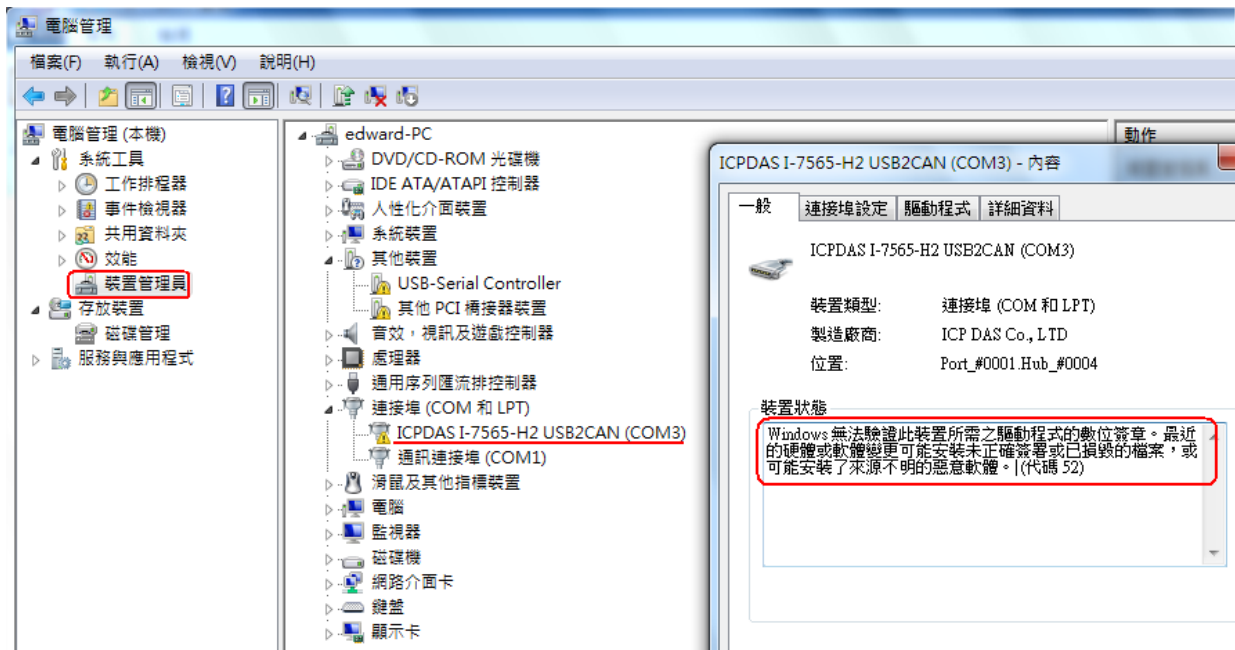

(Fig 7.11-1 Error Without Driver Signature Certificate)

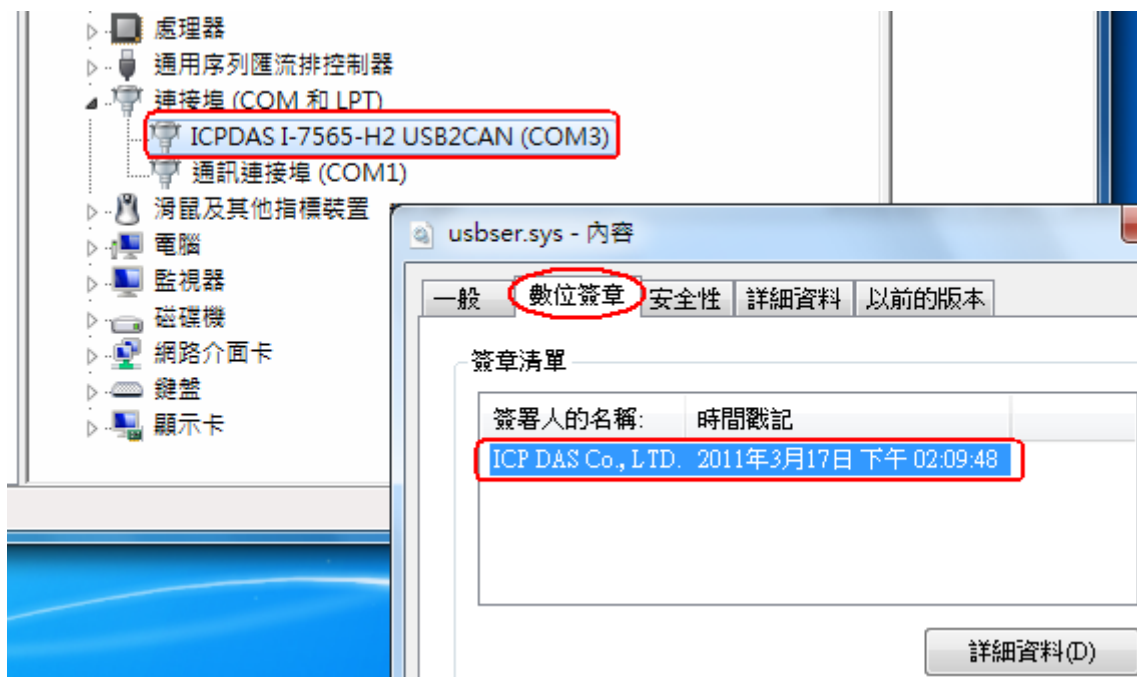

(Fig 7.11-2 With Driver Signature Certificate)



(Fig 7.11-3 Execute by "System Administrator" Authority)

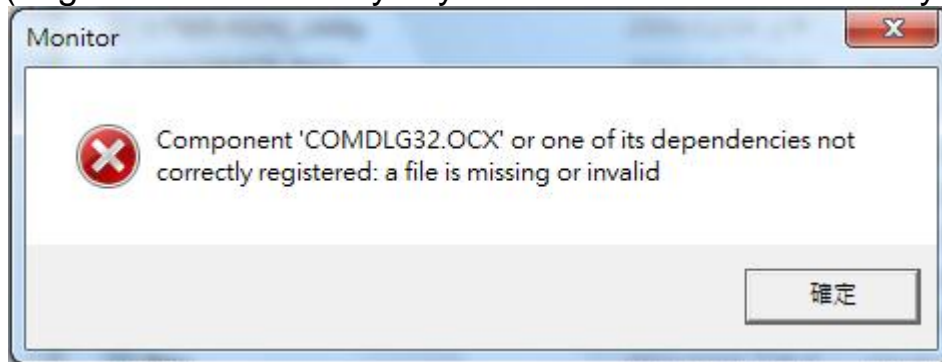

(Fig 7.11-4 Component not correctly registered)

7.12 I-7565-H1/H2 can't receive CAN message

1. Please check the following items in I-7565-H1/H2 module.
 - (1) CAN_H and CAN_L pins are wired to CAN device correctly.
 - (2) CAN baudrate of all CAN devices is the same.
 - (3) CAN Filter-ID setting if it is enabled already.
 - (4) The resistor value of CAN_H and CAN_L pins is about 60 ohm.
 - (5) In the CAN bus occasion filled with electromagnetic interference.
(Such as motor starts causing interference)
2. Adjust the bit-timing of CAN baud (Tseg2 value => FW_v1.07).
Choose the bigger value of Tseg2 and then test CAN communication again. (Refer to FAQ 7.14)
3. Enable "CAN Error Frame" function (FW_v1.07) and then check if the CAN error frame happened in CAN bus. (Refer to FAQ 7.15)

4. Check the “CAN Filter-ID” function if it is set or not by using I-7565-H1/H2 utility.
5. If the above methods can’t solve this problem, please execute the “Reset CANFID Flash” function in the “Configuration” - > “Extra Config” function screen (refer to section 4.4.3) to clear the Filter-ID Flash data of CAN1/2. Then the problem will be resolved. (Note, please check the I-7565-H1/H2 firmware version is v1.06 or newer and utility version is v1.10 or newer to support the “Reset CANFID Flash” function.)

7.13 I-7565-H1/H2 provides LabVIEW Driver

User can download LabVIEW 8.x library and Demo from ICP DAS web site => ftp://ftp.icpdas.com/pub/cd/fieldbus_cd/can/converter/i-7565-h1h2/software/library/win2k_xp/

7.14 How to adjust the Bit-Timing parameters of I-7565-H1/H2 ?

In firmware v1.07 and utility v1.13 or newer, I-7565-H1/H2 module has supported the following functions.

- (1) Adjustable Bit-Timing parameter, Tseg2 value, of CAN baud rate like Figure 7-14-1.
- (2) Show the Bit-Timing parameters including T1, T2 and SJW values used in I-7565-H1/H2 module like Figure 7-14-2.

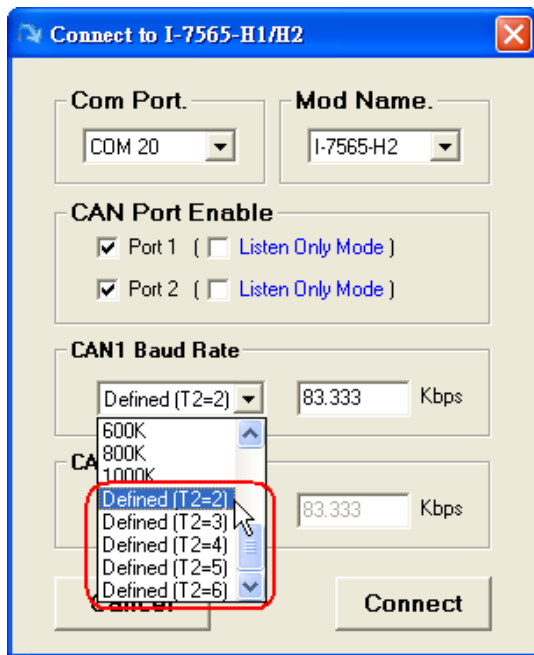

Figure 7-14-1 Adjust “T2”

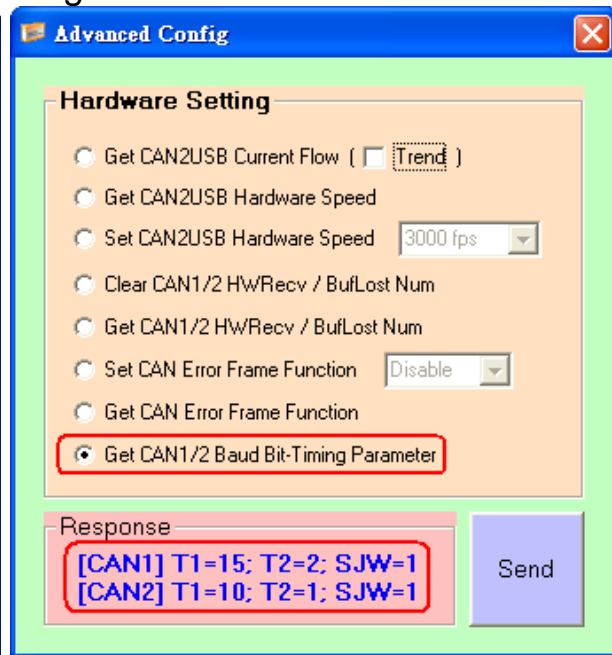

Figure 7-14-2 “T1, T2 and SJW”

7.15 How to enable “CAN Error Frame” function of I-7565-H1/H2 ?

In firmware v1.07 and utility v1.12 or newer, I-7565-H1/H2 module has provided the “CAN Error Frame” information function. Please refer the below steps to enable it.

(1) Run “I-7565-H1/H2” utility and connect to I-7565-H1/H2 module.

(2) In “**Advanced Config**” screen, click the “**Set CAN Error Frame Function**” item and choose “**Enable**” option. Then click “**Send**” button to enable the function like Figure 7-15-1.

(3) If CAN error has happened, the CAN error information will be shown in “**CAN RecvMsg**” field. Users can click the error column to see the detailed error information like Figure 7-15-2.

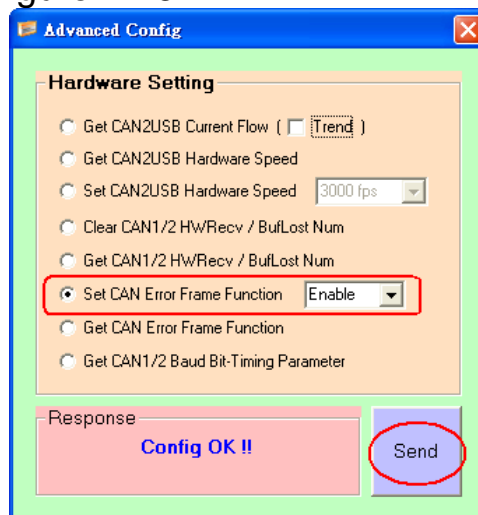

Figure 7-15-1 Enable “CAN Error Frame” Function

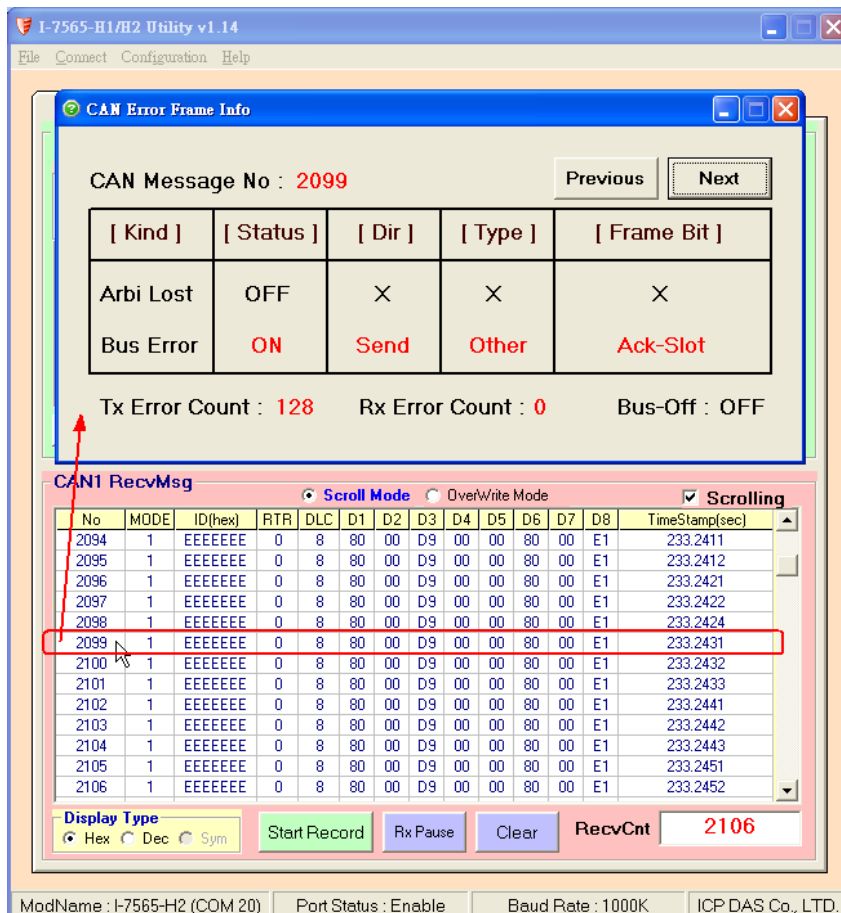

Figure 7-15-2 The detailed CAN Error Information

7.16 New function - "OverWrite" supported in Utility v1.09 ?

In utility v1.09 or newer, the "OverWrite" function option is added in "RecvMsg" field. It is used to assign the received CAN messages with the same "Mode" and "ID" value to the same row. The "Num" field is the total number and the "CycleTime" field is the period for the received CAN messages with the same "Mode" and "ID" value.

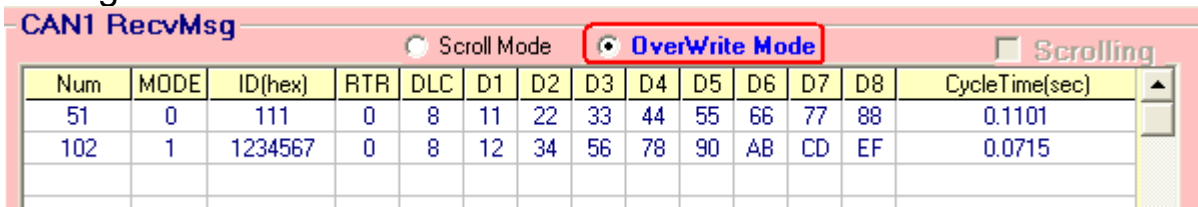

Figure 7-16-1 "OverWrite" Screen

7.17 New function - "Symbolic" supported in Utility v1.10 ?

In utility v1.10 or newer, the "Sym" function option is added

in "Display Type" area of the "RecvMsg" field. The "Sym" function just supports in "OverWrite" mode. It is used to replace the ID value with the assigned string like Figure 7-17-1. (Run "Load Symbol File" first)

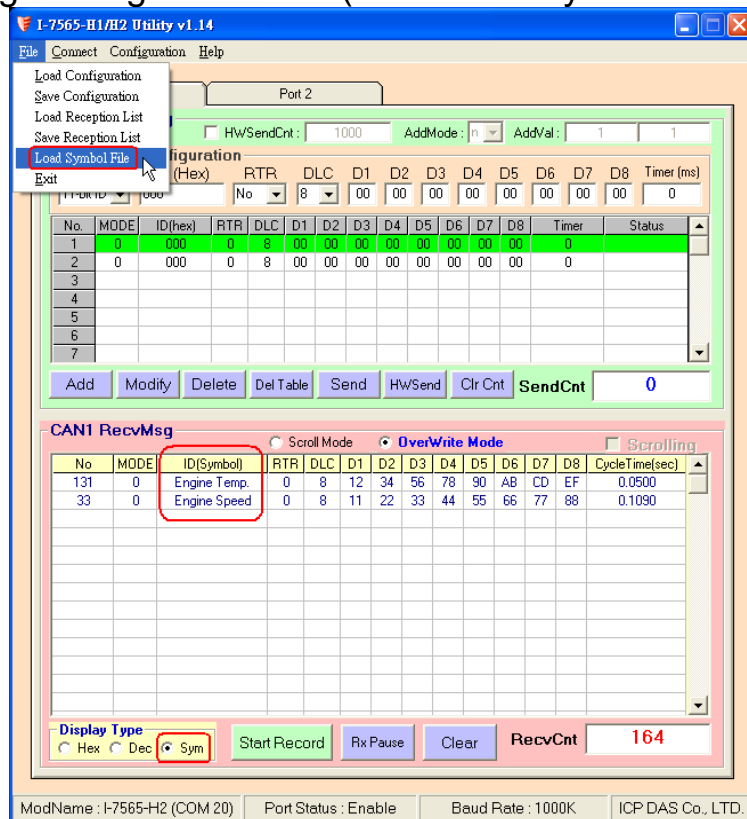

Figure 7-17-1 "Symbolic" Screen

7.18 How to send the CAN messages precisely ?

(1) Using I-7565-H1/H2 Utility :

First, add the assigned CAN message for sending. Then users can click "HWSend" button to send the assigned CAN message permanently with the precise hardware timer. If users just want to send the assigned count, please check the "HWSendCnt" item and input the count for sending.

(2) Using I-7565-H1/H2 API Library :

In I-7565-H1/H2 library, users can use **VCI_EnableHWCyclicTxMsgNo()** function (v1.08 or newer support) to send the assigned CAN message with the precise hardware timer.

7.19 Listen CAN messages without affecting CAN Comm. ?

Users can use the "Listen Only" function to do that.

(1) Using **I-7565-H1/H2 Utility** :

In “Connection” screen, please check “Listen Only Mode” item like figure 7-19-1 and then click the “Connect” button to connect to I-7565-H1/H2 module. After the connection is successful, the execution screen will be like figure 7-19-2.

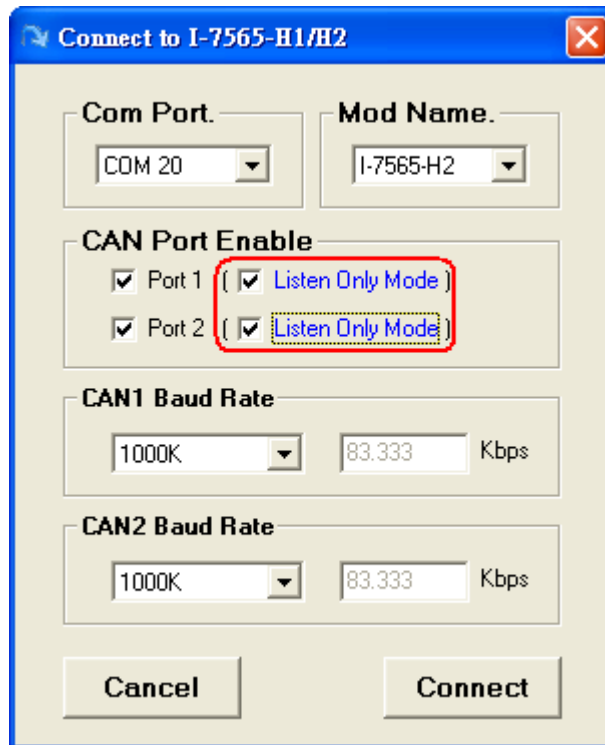

Figure 7-19-1 "Listen Only Mode" option screen

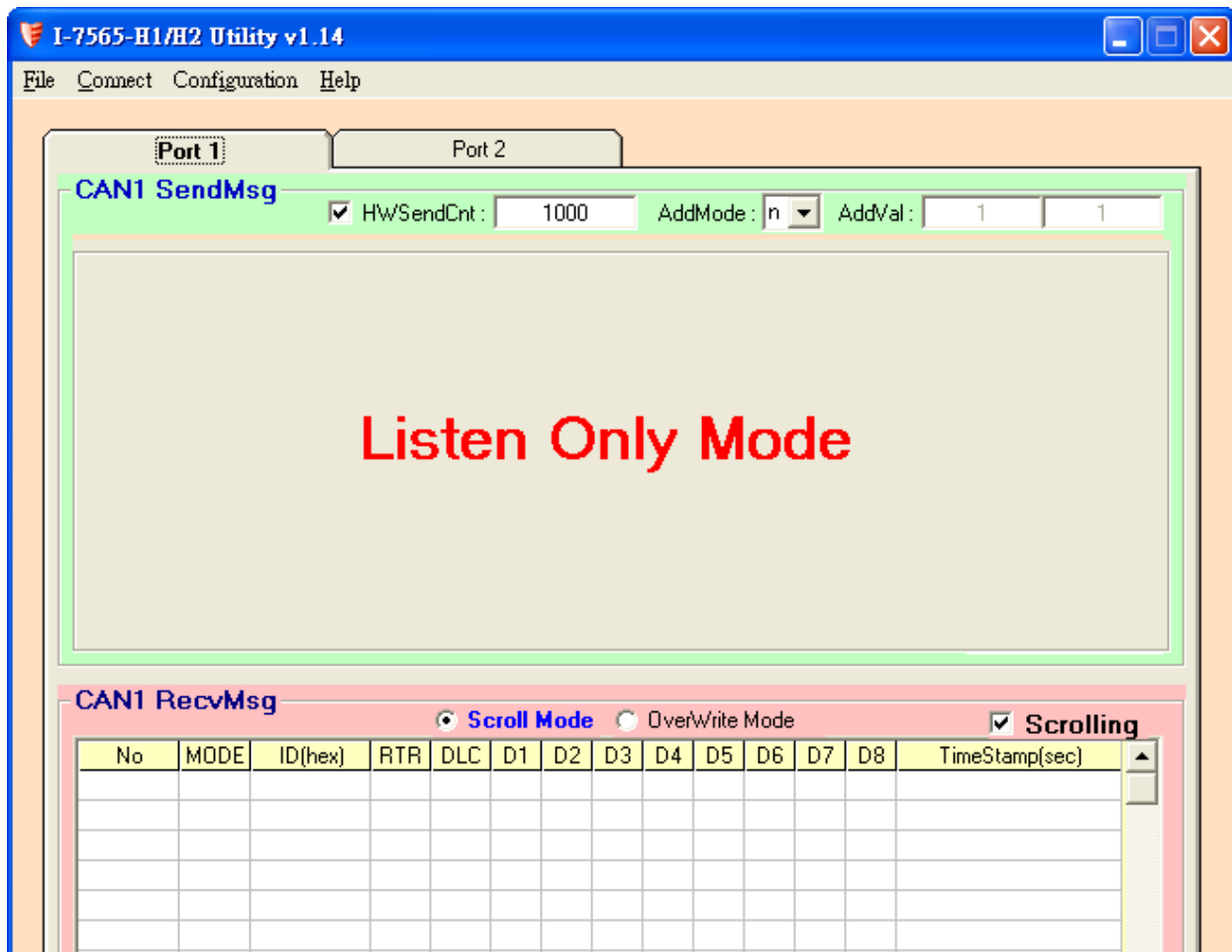

Figure 7-19-2 "Listen Only Mode" Execution Screen

(3) Using **I-7565-H1/H2 API Library** :

In I-7565-H1/H2 library, users can use the **VCI_Set_MOD_Ex()** function (v1.10 or newer support) to set the "Listen Only Mode" function.

7.20 How to get the current CAN bus data flow ?

In the "Advanced Config" screen of I-7565-H1/H2 utility, users can click "**Get CAN2USB Current Flow**" option like figure 7-20-1 and then click the "Send" button to open the "CAN bus DataFlow" screen to show the current CAN bus data flow like figure 7-20-2.

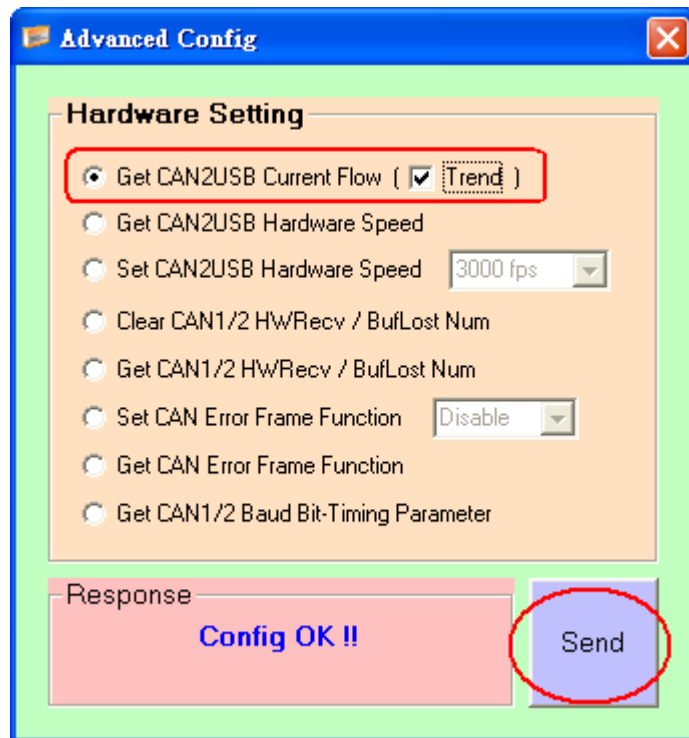

Figure 7-20-1 "Get CAN2USB Current Flow" Option

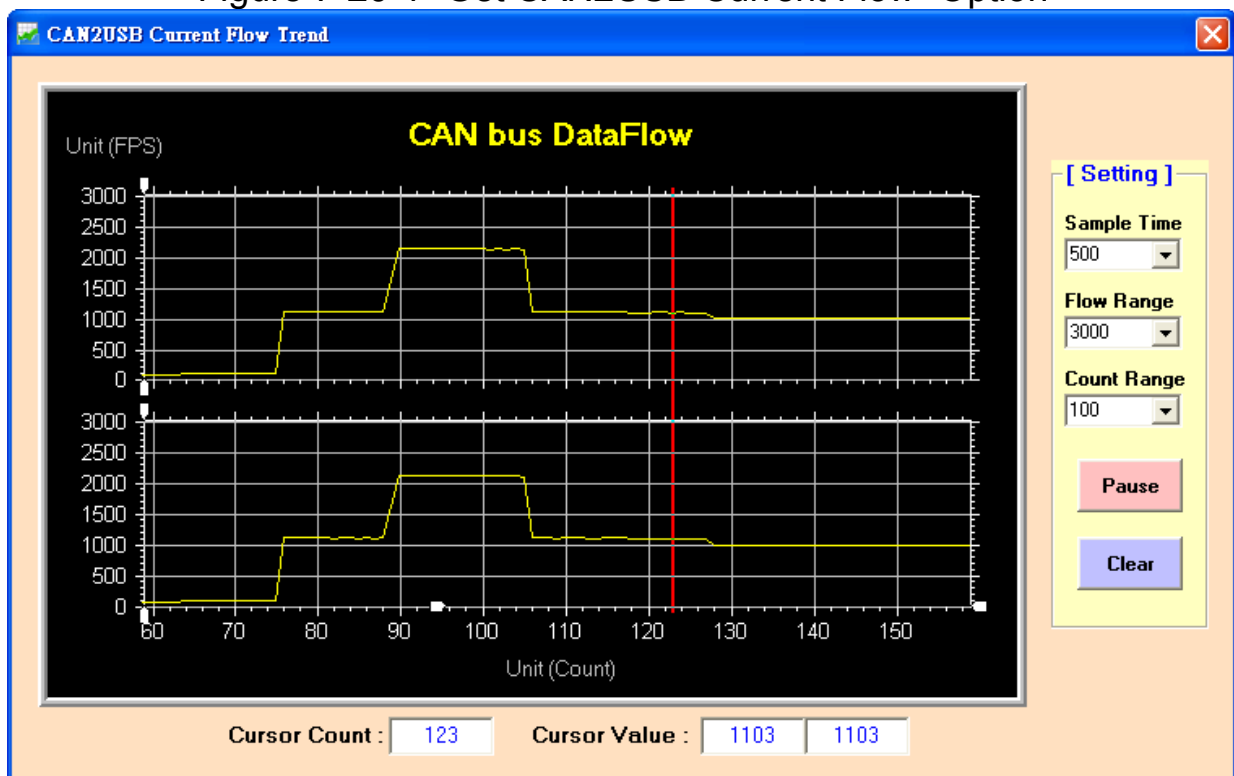

Figure 7-20-2 "CAN bus DataFlow" Screen

7.21 How to make I-7565-H1/H2 become a CAN data logger ?

In I-7565-H1/H2 utility, users can use the "Start Record" button

function in “RecvMsg” field to do that like figure 7-21-1. When users click the “Start Record” button, it will produce a record file automatically named by date and time like “CAN1_20130102_100339.txt” in the same folder of I-7565-H1/H2 utility. It can also choose how many the received CAN data saved in the record file like figure 7-21-2.

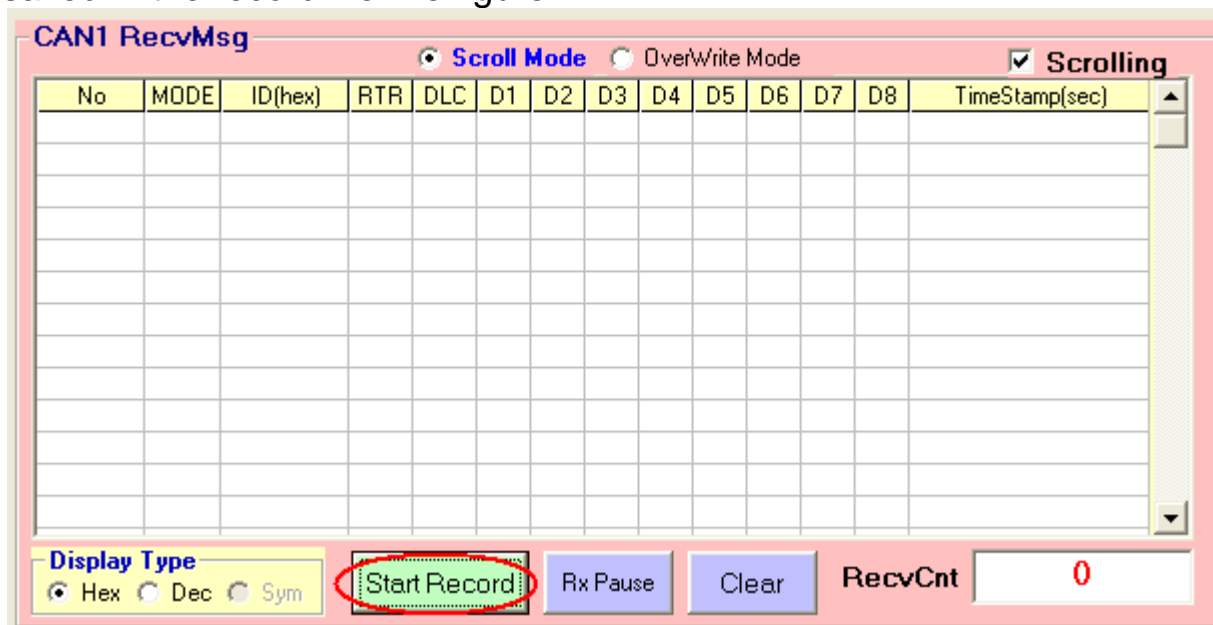

Figure 7-21-1 "Start Record" button

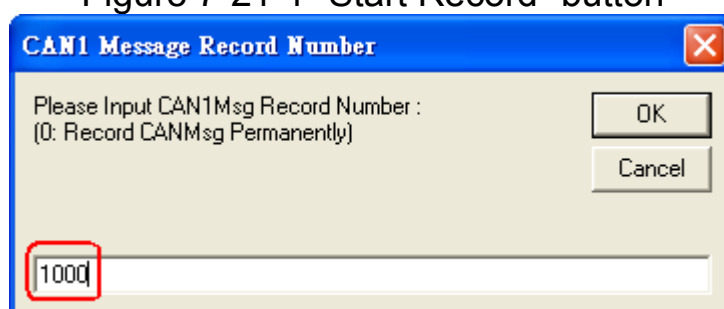

Figure 7-21-2 CAN Message Record Number

7.22 How to receive the assigned CAN-ID data immediately ?

In I-7565-H1/H2 API library, the “VCI_Set_UserDefISR” function is used to do that. For example, users want to receive the CAN1 data with Mode=11bit, ID=0x100. Please see the below example code.

- (1) Execute “VCI_OpenCAN()” first to open CAN port of I-7565-H1/H2.
- (2) Execute VCI_Set_UserDefISR(1, CAN1, MODE_11BIT, 0x100, MyTestISR1) function.
- (3) When received the assigned CAN message, the program will run “MyTestISR1” function once. Therefore, in “MyTestISR1” function, users

can execute “VCI_Get_ISR CANData()” function to get the assigned CAN message data.

[Note]

(1) The time spent in “MyTestISR1” function should be the shorter the better, otherwise it may cause the assigned CAN data loss.

7.23 Does API of I-7565-H1/H2 support Visual Studio Express ?

Yes, it does. The usage is all the same with the .Net demo of I-7565-H1/H2.

7.24 When DotNet demo runs in Win7_x64 OS, it will show the

“0x8007000B” or “System.NullReferenceException” error ?

Please modify the CPU option of I-7565-H1/H2 .Net Demo from “AnyCPU” to “x86” and then re-compile the demo again. After that, the .Net demo will run well.

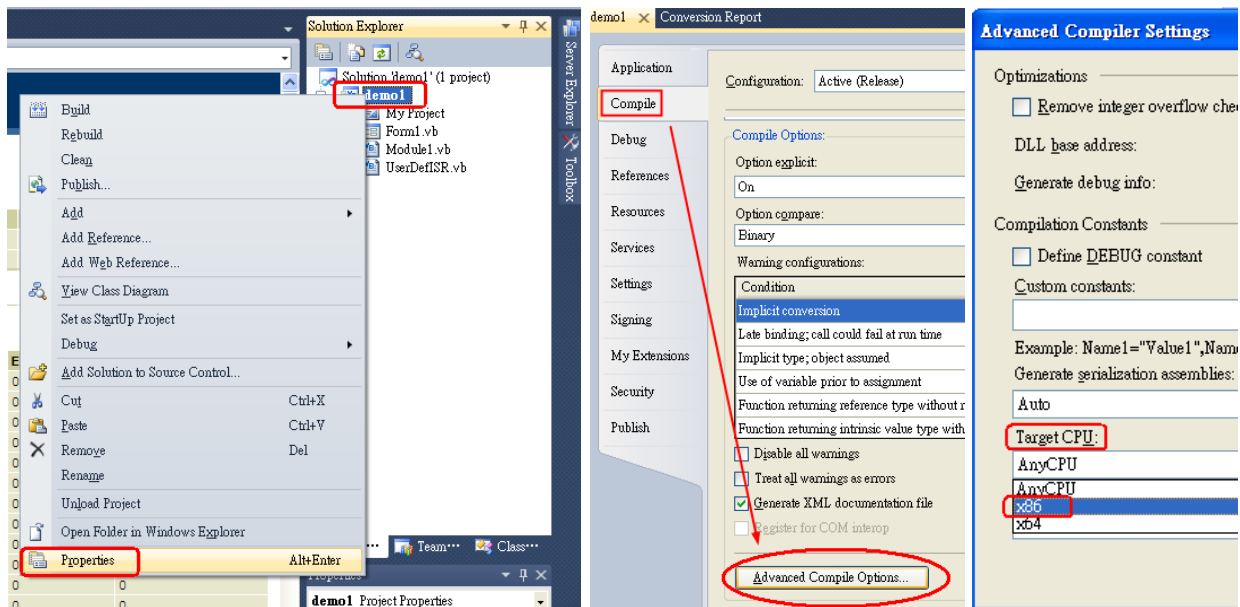

7.25 Windows 10 Issues

7.25.1 In Windows 10, how to install I-7565-H1/H2 driver correctly ?

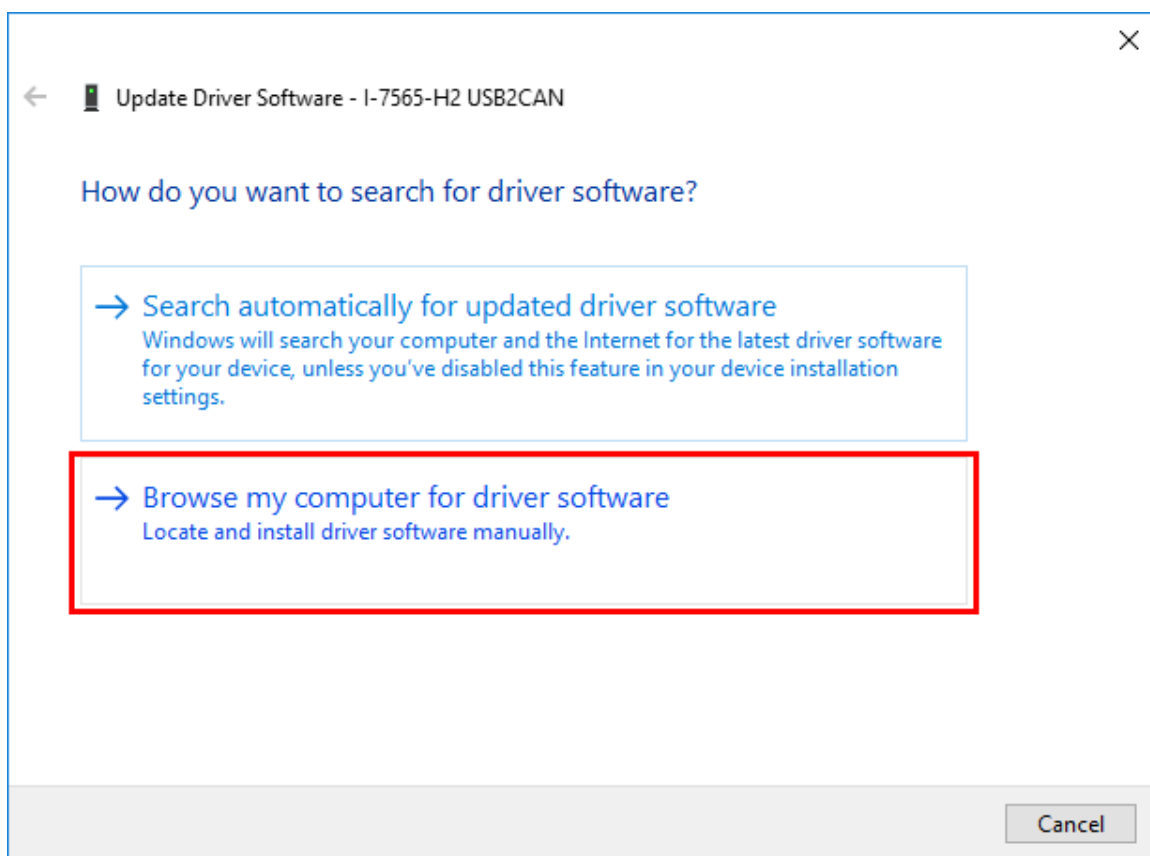
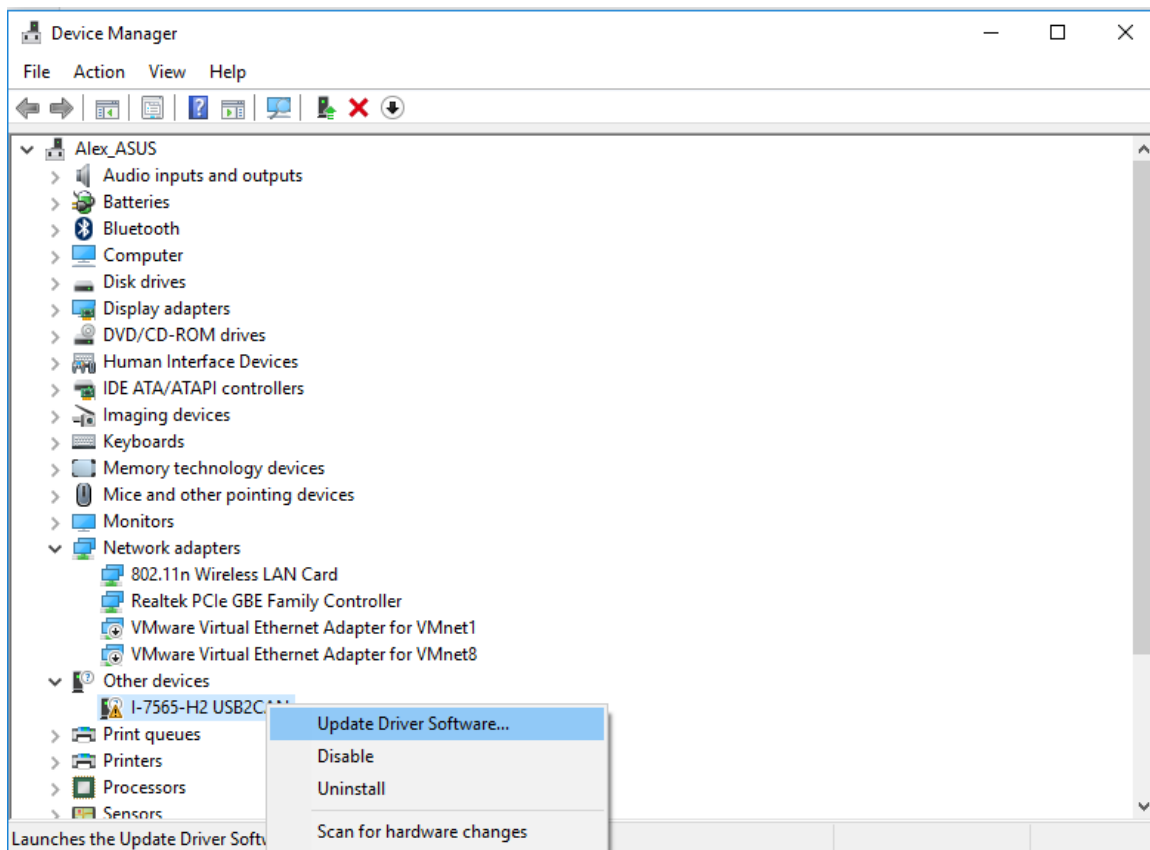

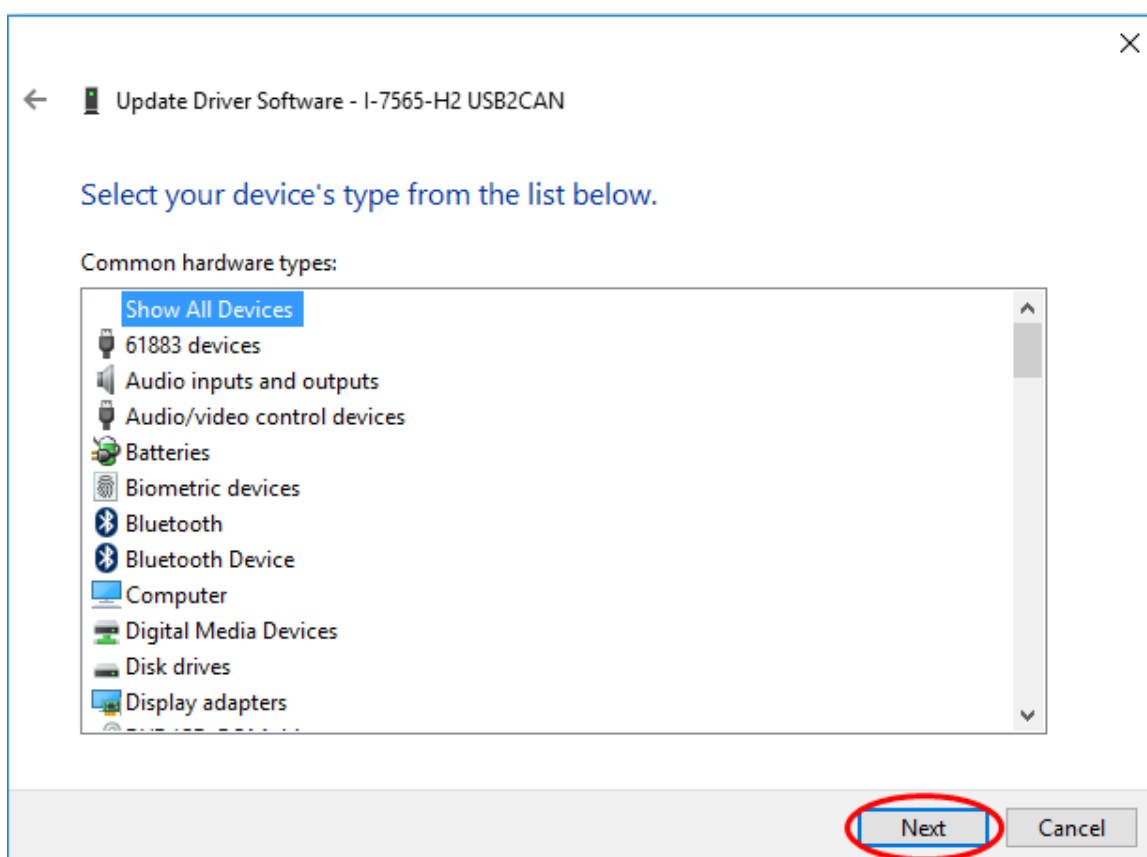
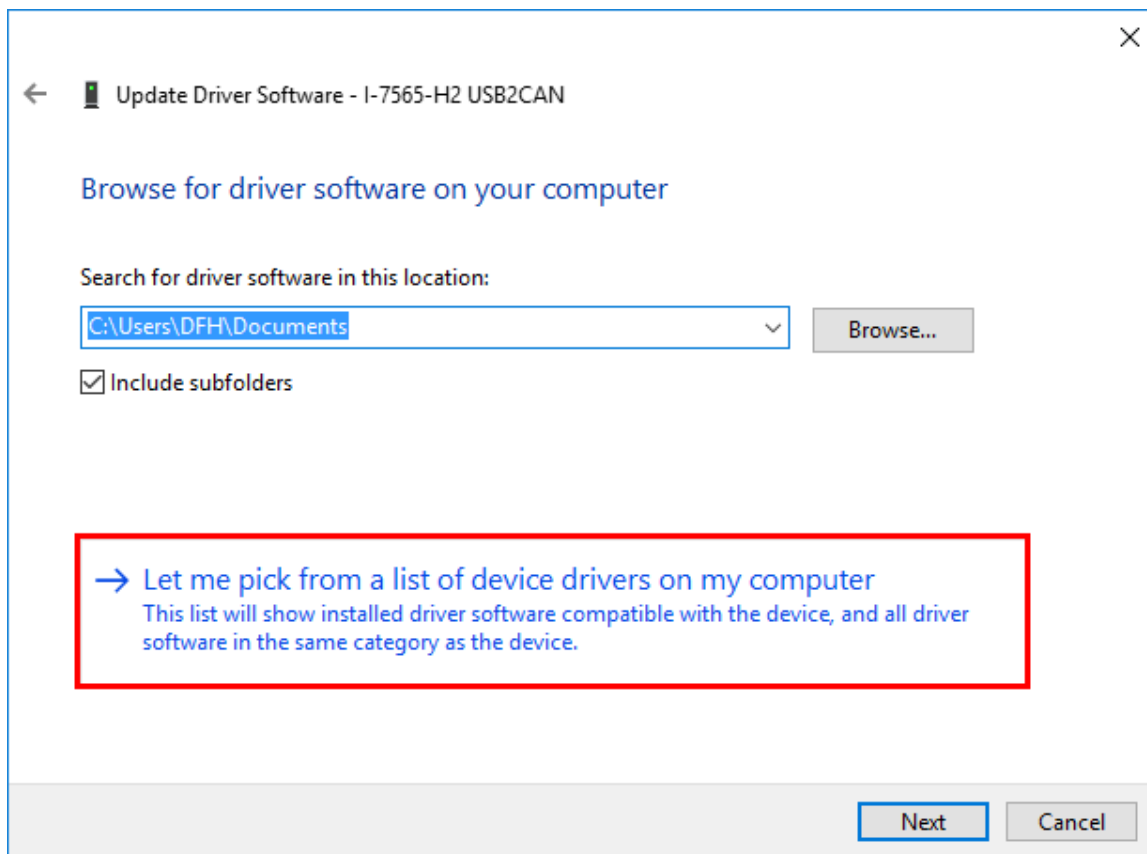

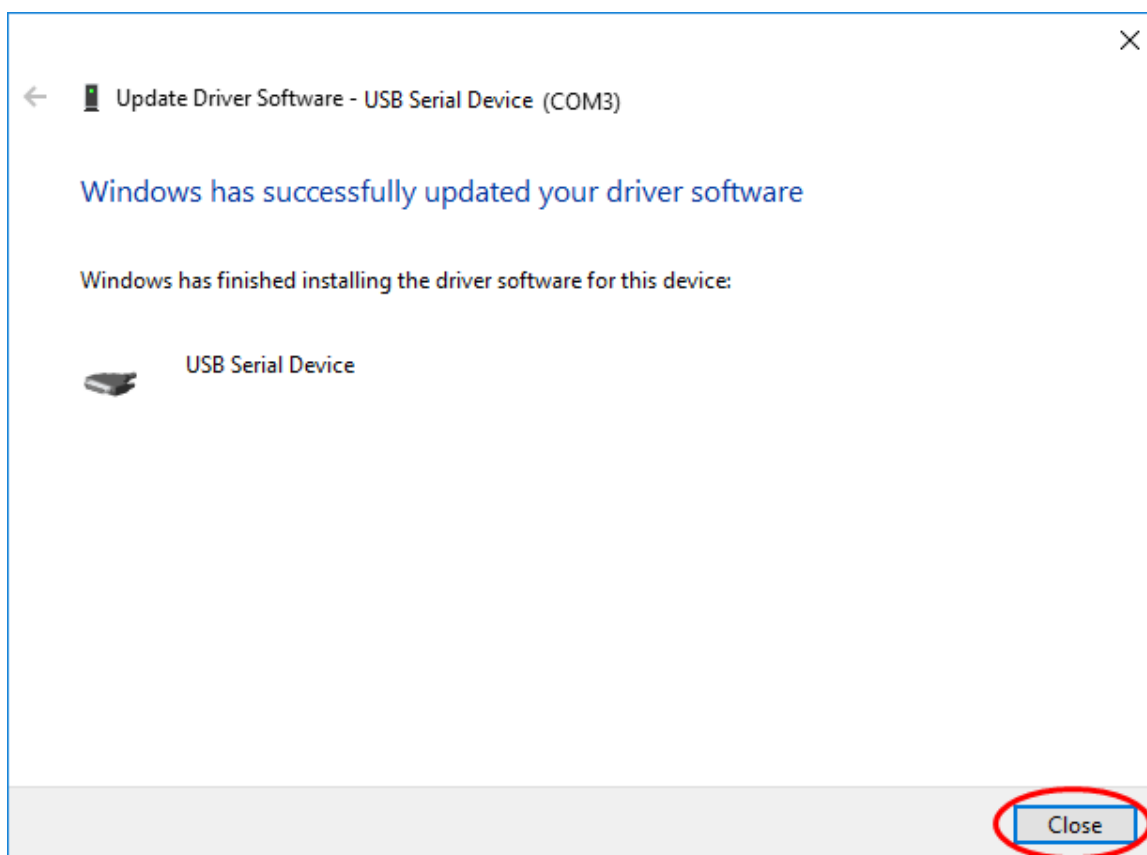
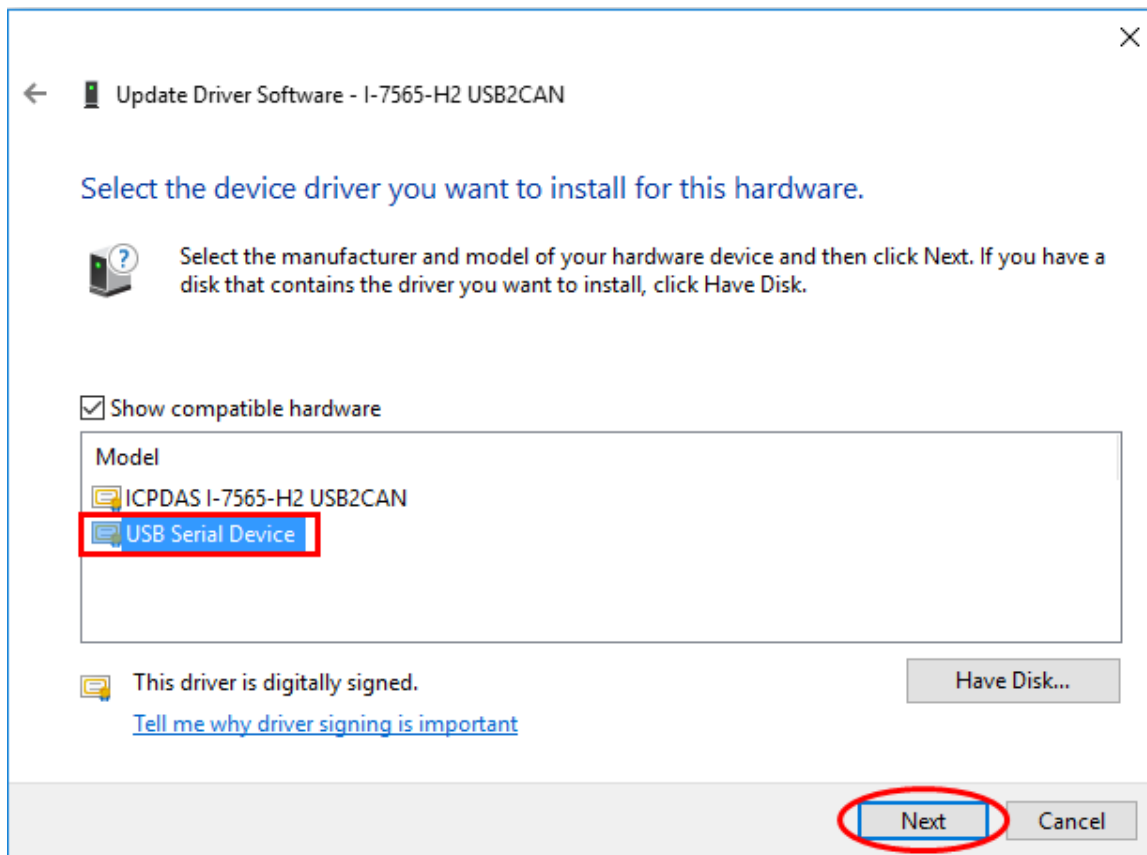

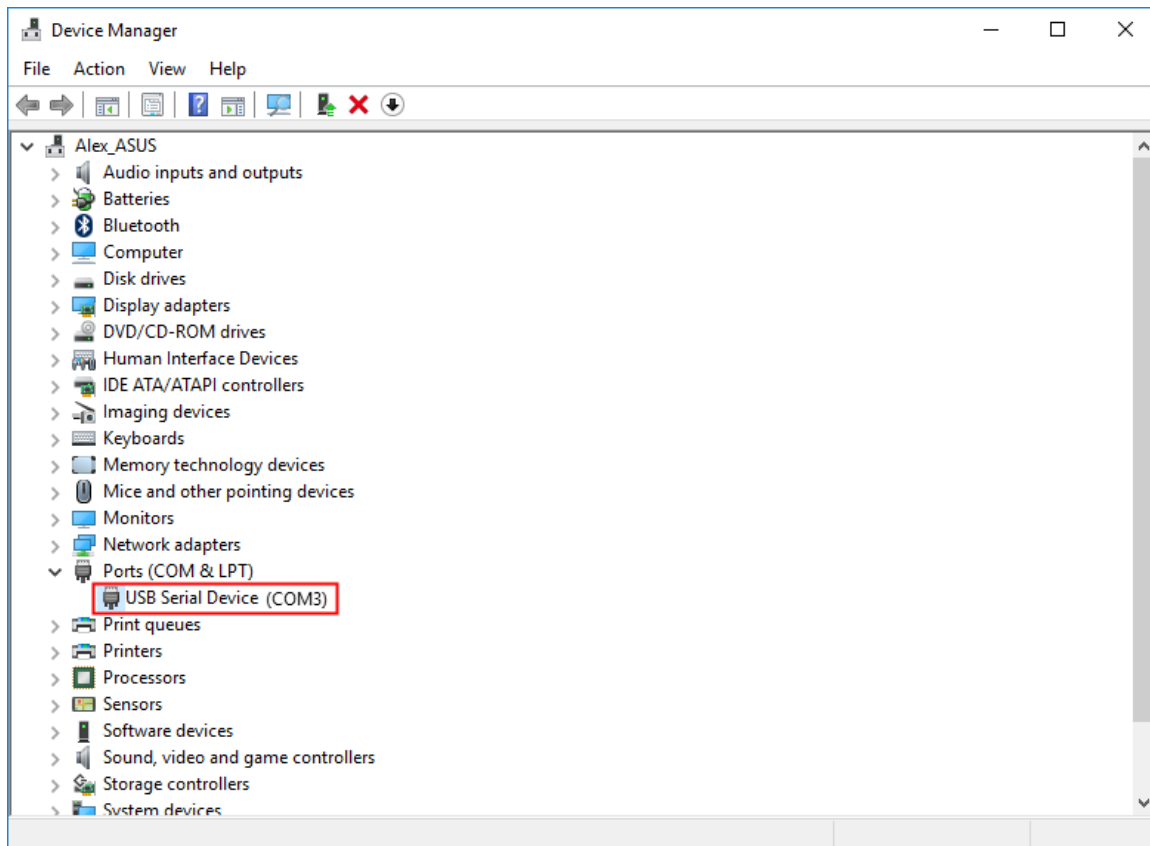

7.25.2 In Windows 10, how to use I-7565-H1/H2 utility ?

1. In Windows10, please execute “I-7565-H1H2_UTILITY_Win10.exe”.
2. The below is the test for VC_Demo1 or VB_Demo1 by using I-7565-H2 with CAN1/CAN2 port connection together.

(1) Open ComPort :

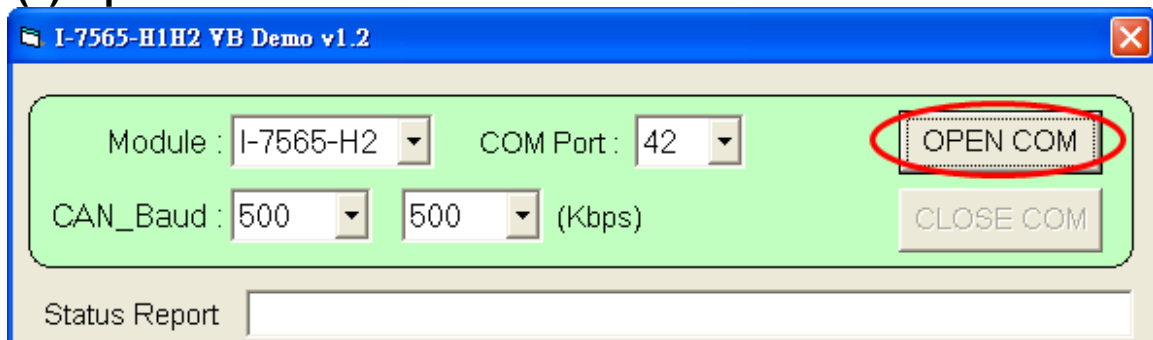

(2) CAN1 Send and CAN2 Receive :

CAN Command Send

ID (Hex)	RTR	DLC	Data1	Data2	Data3	Data4	Data5	Data6	Data7	Data8
123	0	8	12	34	56	78	90	AB	CD	EF

Extend (29-bit ID) CAN_Port : CAN1 **Send**

CAN1/2 RecvMsg ([TimeStamp(Sec)] => Mode, ID, RTR, DLC, Data0~7)

```

CAN2 : [ 2074.9670 ] ==> 0 123 0 8 12_34_56_78_90_AB_CD_EF
CAN2 : [ 2075.1506 ] ==> 0 123 0 8 12_34_56_78_90_AB_CD_EF
CAN2 : [ 2075.3420 ] ==> 0 123 0 8 12_34_56_78_90_AB_CD_EF

```

CAN1_RecvMsg : 0
CAN2_RecvMsg : 3 Auto RxScan Clear Buffer Receive Data

(3) CAN2 Send and CAN1 Receive :

CAN Command Send

ID (Hex)	RTR	DLC	Data1	Data2	Data3	Data4	Data5	Data6	Data7	Data8
123	0	8	12	34	56	78	90	AB	CD	EF

Extend (29-bit ID) CAN_Port : CAN2 **Send**

CAN1/2 RecvMsg ([TimeStamp(Sec)] => Mode, ID, RTR, DLC, Data0~7)

```

CAN2 : [ 2074.9670 ] ==> 0 123 0 8 12_34_56_78_90_AB_CD_EF
CAN2 : [ 2075.1506 ] ==> 0 123 0 8 12_34_56_78_90_AB_CD_EF
CAN2 : [ 2075.3420 ] ==> 0 123 0 8 12_34_56_78_90_AB_CD_EF
CAN1 : [ 2117.3757 ] ==> 0 123 0 8 12_34_56_78_90_AB_CD_EF
CAN1 : [ 2117.5984 ] ==> 0 123 0 8 12_34_56_78_90_AB_CD_EF
CAN1 : [ 2117.8231 ] ==> 0 123 0 8 12_34_56_78_90_AB_CD_EF
CAN1 : [ 2119.6161 ] ==> 0 123 0 8 12_34_56_78_90_AB_CD_EF
CAN1 : [ 2120.3426 ] ==> 0 123 0 8 12_34_56_78_90_AB_CD_EF

```

CAN1_RecvMsg : **5**
CAN2_RecvMsg : 3 Auto RxScan Clear Buffer Receive Data

7.26 When setting CAN Filter-ID by using VCI_Set_CANFID

failed, It may cause module connection failed ?

A26: (2017/12/20)

1. Reboot PC. Run I-7565-H1/H2 utility and click (x) to close the connection screen.

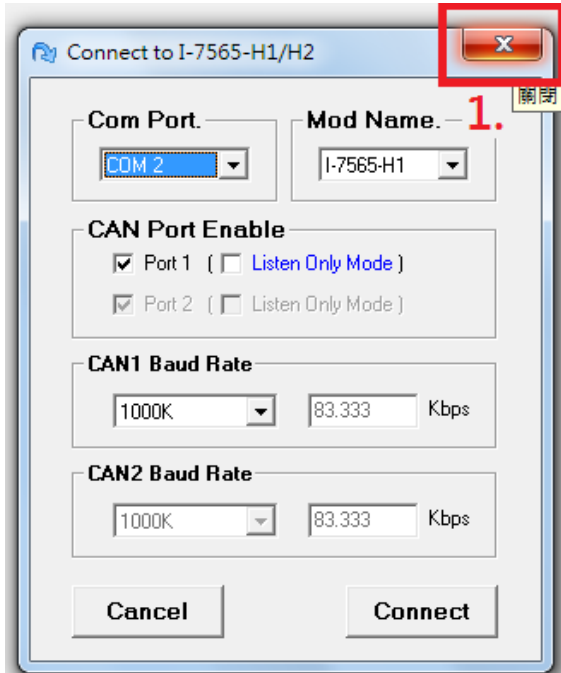

2. Click the “Configuration -> Extra Config” option.
3. Choose the “Com Port” and click the “Connect” button.
4. Click the “Reset CANID Flash” button to clear all the CAN filter-ID settings of I-7565-H1/H2.

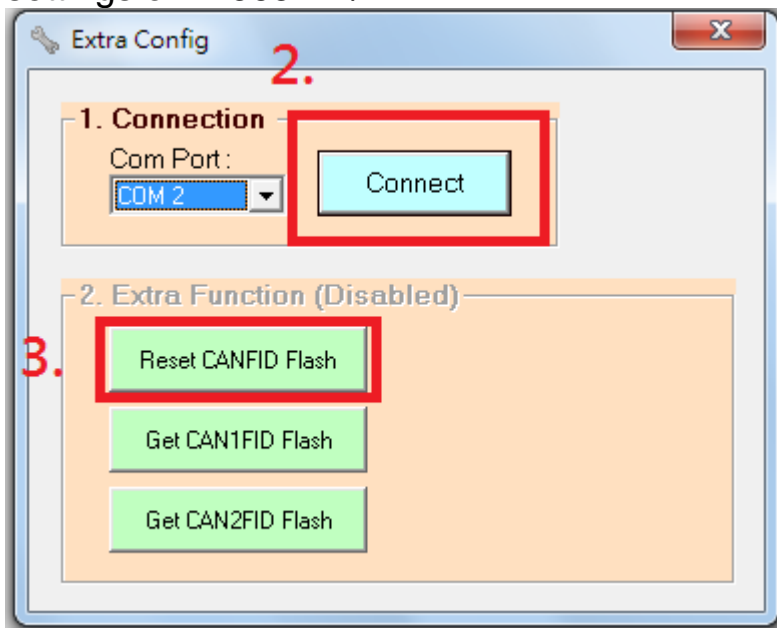

5. Now it should connect to I-7565-H1/H2 successfully.

7.27 How to use Excel to open CAN received record file ?

A27: (2017/12/20)

1. Run the “Excel” program and choose the “TXT file(*.txt)” to open.
2. Choose the “Delimited” option and click the “Next” button.

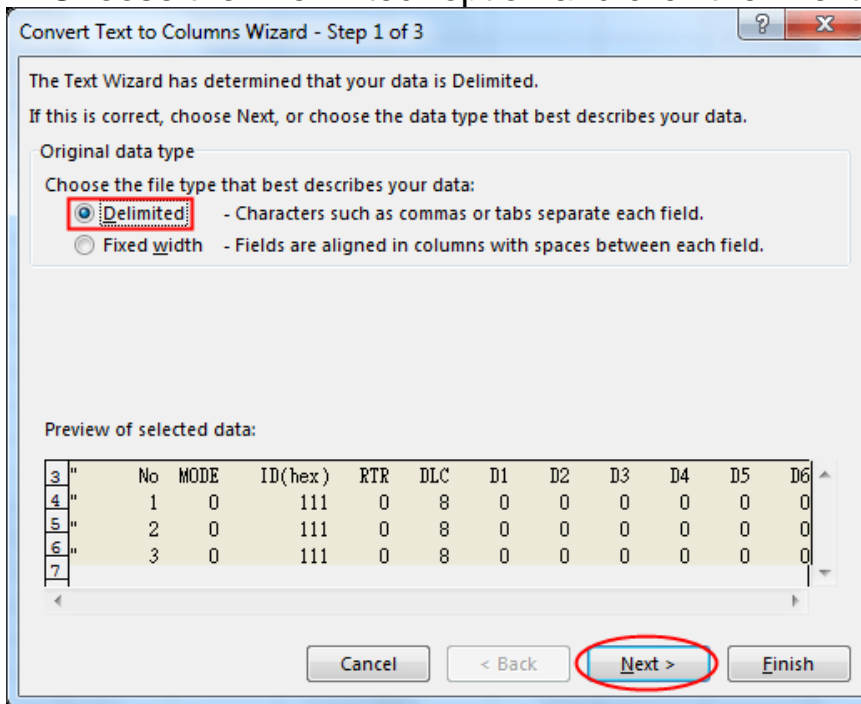

3. Choose the “Space” and “Other” (with ”) option and click the “Finish” button.

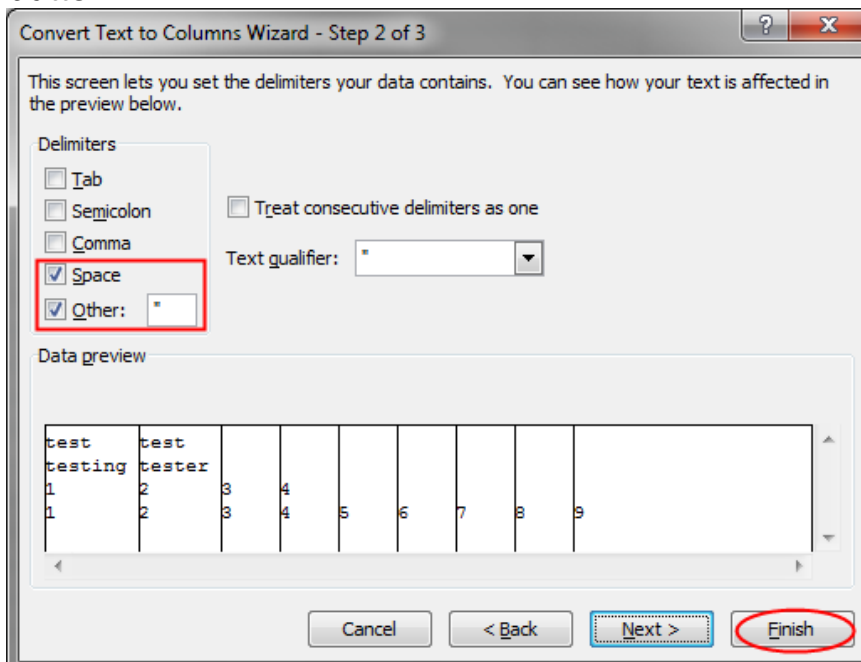

	A	B	C	D	E	F	G	H	I	J	K	L	M	N	O	P
1		No	MODE	ID(hex)	RTR	DLC	D1	D2	D3	D4	D5	D6	D7	D8	TimeStamp(sec)	
2		1	0	111	0	8	0	0	0	0	0	0	0	0	1612.7703	
3		2	0	111	0	8	0	0	0	0	0	0	0	0	1612.9509	
4		3	0	111	0	8	0	0	0	0	0	0	0	0	1613.1157	
5		4	0	111	0	8	0	0	0	0	0	0	0	0	1613.5251	
6		5	0	111	0	8	0	0	0	0	0	0	0	0	1613.7434	
7																
8																

8. Linux User Manual

Users can download Linux user manual of I-7565-H1H2 from ftp://ftp.icpdas.com/pub/cd/fieldbus_cd/can/converter/i-7565-h1h2/manual/linux/

9. History of Version

Version	Author	Date	Description of changes
1.0	Edward	22-Sep-2009	The First Version
1.1	Edward	25-Nov-2009	<ol style="list-style-type: none"> 1. Modify the connection screen of Utility. 2. Add connection issue content. 3. Provide Firmware Update Tool.
1.2	Edward	7-Apr-2010	<ol style="list-style-type: none"> 1. Modify the Utility to be v1.04. 2. Add automatic driver installation function. 3. Provide API functions without structure (For VCI_CAN Lib v1.04)
1.3	Edward	29-Nov-2010	<ol style="list-style-type: none"> 1. Add multi-modules control API library – “mVCI_CAN” v1.00 2. Update the Utility to be v1.07 3. Update VCI_CAN.dll to be v1.06
1.4	Edward	08-Dec-2010	<ol style="list-style-type: none"> 1. Provide “mVCI_CAN_vb.dll” for multi-modules control in VB.
1.5	Edward	17-Mar-2011	<ol style="list-style-type: none"> 1. Provide “User Defined ISR” Function 2. Provide “Hardware Serial Number” Function. (For VCI_CAN Lib v1.07) 3. Driver update to v1.2 (Add Driver Signature Certificate) and modify driver installation file name to be ICPUsbConverter_DrvInst (Integrate I-7567 module). 4. Utility update to v1.08 5. VCI_Get_ISRCANData function is added in VCI_CAN Lib v1.073.
1.6	Edward	25-May-2011	<p>The following functions provided in <u>FW: v1.05 / Utility: v1.09 / APILib: v1.08</u></p> <ol style="list-style-type: none"> 1. Provide “Listen Only Mode” function. 2. Increase HWSendTimer Number from 1 set to 5 sets. 3. Add “AddMode” and “AddVal” parameter for HWSendTimer. 4. Provide “CAN bus Flow Trend” function in Utility. 5. Provide “Scroll” and “OverWrite” mode for CAN RecvMsg Table in Utility.

1.7	Edward	19-Aug-2011	<p>The following functions provided in FW: v1.06 / Utility: v1.10</p> <ol style="list-style-type: none"> 1. Add “Arbitration Lost” error field in Utility. 2. Add “Extra Config” function page in Utility. 3. Add “Load SymbolFile” function in Utility. 4. Add “Sym” mode of Display Type for CAN RecvMsg Table in Utility.
1.8	Edward	27-July-2012	<p>The following functions provided in FW: v1.07 / Utility: v1.12 / APILib: v1.09</p> <ol style="list-style-type: none"> 1. Provide “CAN Error Frame” function. 2. Add adjustable “Sample Point of Bit-Timing” function (Tseg2) in “User-Defined CAN Baud”. 3. Utility add the below three options: <ol style="list-style-type: none"> (1) Set CAN Error Frame Function (2) Get CAN Error Frame Function (3) Get CAN1/2 Baud Bit-Timing Parameter
1.9	Edward	15-Nov-2012	<ol style="list-style-type: none"> 1. Utility_v1.13 adds the below functions: <ol style="list-style-type: none"> (1) “Load Reception List” function 2. APILib_v1.10: <ol style="list-style-type: none"> (1) Add “VCI_Set_MOD_Ex()” function.
2.0	Alan	29-Apr-2015	Embellish wire connection and pin assignment graphs
2.1	Edward	15-June-2015	<ol style="list-style-type: none"> 1. Add the content of Troubleshooting. 2. provide the download of Linux User Manual for I-7565-H1/H2.
2.2	Edward	2016/06/06	<ol style="list-style-type: none"> 1. Add section 5.7.4 ~ 5.7.7. 2. Add FAQ 7.25 (Windows 10 Issues) 3. Update Linux API Library to v0.3.6
2.3	Edward	2016/07/21	<ol style="list-style-type: none"> 1. Improve VC_Demo1 and VB_Demo1. 2. In utility v1.16, add the max/min time interval of CAN message in the cycletime field of “OverWrite” mode.
2.4	Edward	2017/12/20	<ol style="list-style-type: none"> 1. Extend the description of 7.12. 2. Add FAQ 7.26 and 7.27.