

# iNS-300 Series

## User Manual

Ver. 1.0.0, Oct. 2021



### WARRANTY

All products manufactured by ICP DAS are warranted against defective materials for a period of one year from the date of delivery to the original purchaser.

### WARNING

ICP DAS assumes no liability for damages consequent to the use of this product. ICP DAS reserves the right to change this manual at any time without notice. The information furnished by ICP DAS is believed to be accurate and reliable. However, no responsibility is assumed by ICP DAS for its use, nor for any infringements of patents or other rights of third parties resulting from its use.

### COPYRIGHT

Copyright © 2021 by ICP DAS. All rights are reserved.

### TRADEMARK

Names are used for identification only and may be registered trademarks of their respective companies.

### CONTACT US

If you have any questions, please feel free to contact us via email at:

[service@icpdas.com](mailto:service@icpdas.com)



### SUPPORT

iNS-306

# **CONTENTS**

<b>1. INTRODUCTION .....</b>	<b>3</b>
1.1 PACKING LIST.....	4
1.2 FEATURES .....	5
<b>2. HARDWARE INFORMATION.....</b>	<b>8</b>
2.1 APPEARANCE.....	8
2.2 SPECIFICATION .....	11
2.3 DIMENSIONS .....	12
<b>3. GETTING STARTED .....</b>	<b>13</b>
3.1 CONFIGURING THE BOOT MODE .....	13
3.2 CONNECTING THE POWER AND THE HOST PC .....	14
3.3 CONFIGURING THE NETWORK SETTINGS .....	15
<b>4. WEB CONFIGURATION .....</b>	<b>18</b>
4.1 HOME.....	18
4.2 NETWORK.....	20
4.3 SCHEDULE.....	26
4.4 FILTER.....	30
4.5 CHANGING PASSWORD .....	31
4.6 LOGOUT .....	32
<b>REVISION HISTORY .....</b>	<b>33</b>

# 1. Introduction

The iNS-306 is a 6-port 10/100Base-TX IoT switch with easy-to-use web interface. It offers 2 Ethernet ports with LAN Bypass feature, and 4 PoE ports for connecting Power over Ethernet (PoE) devices such as wireless access points (APs), IP cameras, and IP phones to the network. In compliance with the IEEE 802.3at standard, each PoE port ensures the PSE function and provides up to 30W for powered devices

The iNS-300 web interface enables you to remotely log into the iNS-300 series module for configuration and maintenance. You can configure the iNS-300 series module, turn off/on or reset the power of the POE Ethernet port, and set power schedule from your browser.

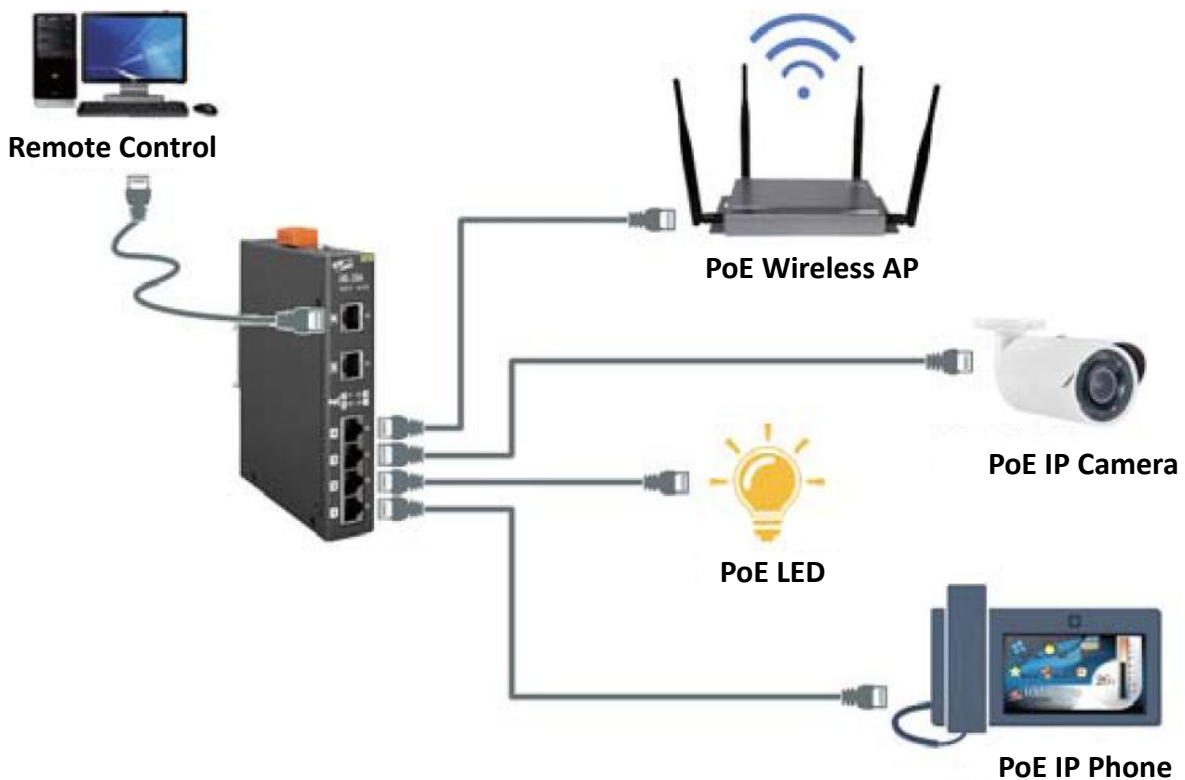

## 1.1 Packing List

The shipping package includes the following items:



iNS-300 Module x 1



Quick Start x 1



### Note

---

*If any of these items are missing or damaged, please contact the local distributor for more information. Save the shipping materials and cartons in case you need to ship the module in the future.*

---

# 1.2 Features

## 1. Built-in Web Server

The iNS-300 series module has a built-in web server that allows users to easily configure, monitor and control the module from a remote location using a web browser.



## 2. Power On/Off Schedule

An individual power on/off schedule is provided for each PoE port of the iNS-300 series module. Auto turning off and turning on the devices at selected times can save manpower, time costs, and power when the devices are not in used.

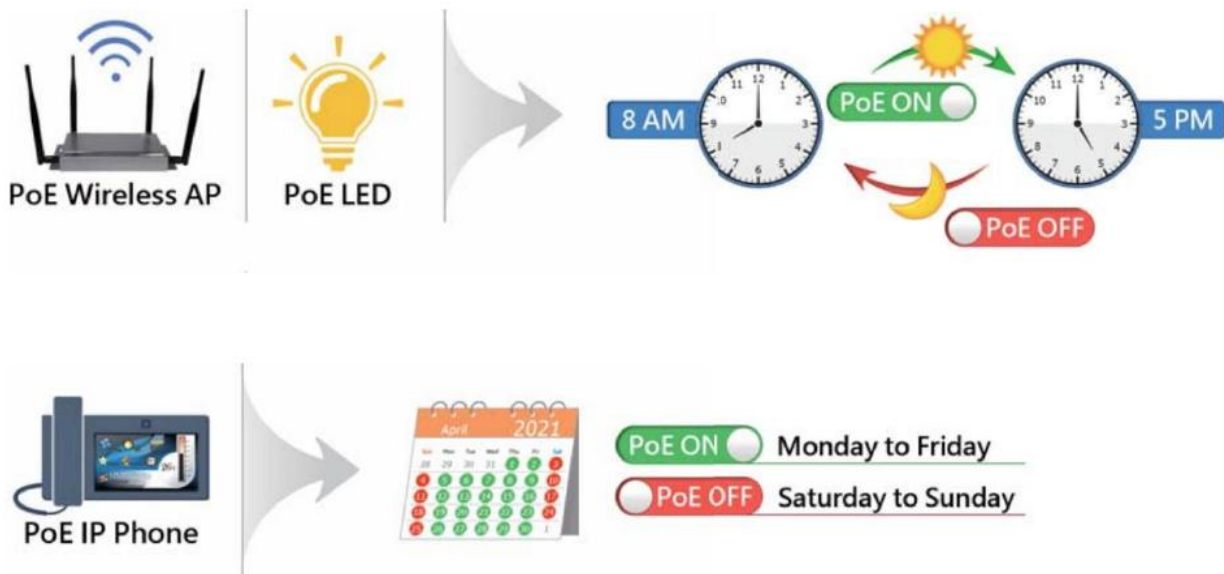

### 3. Power Reset Schedule

The PoE powered devices may become slow or inoperable if they are left on for too long. A simple reset can help you to solve most problems most of the time. The iNS-300 series module offers an individual power reset schedule for each PoE port, you can configure the schedule through a web browser to reset your devices regularly and keep them working in good condition.



### 4. Dual Redundant Power Input

The iNS-300 series module has dual redundant power inputs to ensure reliability. If the main power system fails, the switch can be powered by an UPS or backup power to prevent network disruptions. If the iNS-300 series module will be used on high load conditions (total PoE power load exceeds 60w), it is recommended to configure dual power supplies.

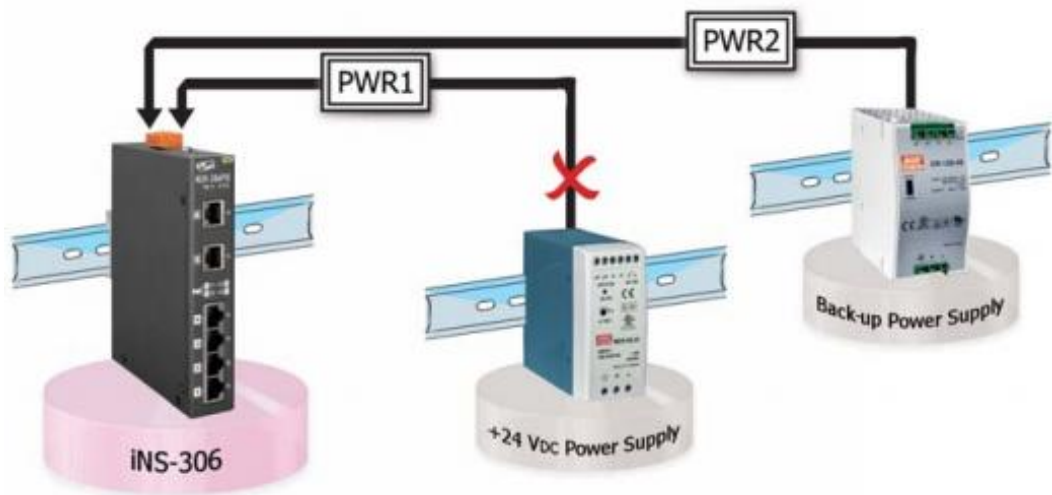

## 5. LAN Bypass

LAN Bypass feature guarantees the Ethernet communication. It will automatically active to ensure the continued flow of important network traffic when the iNS-300 series module loses its power.

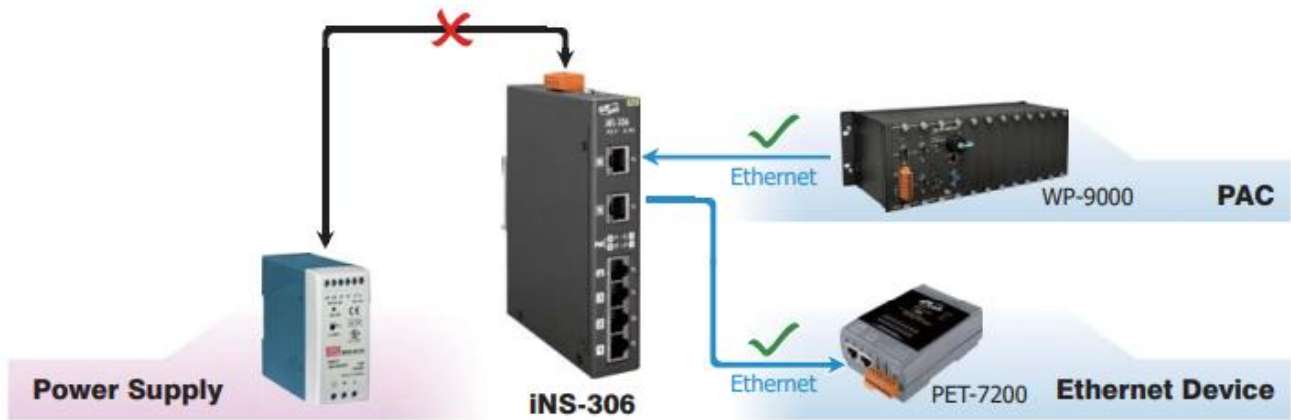

## 6. Highly Reliable Under Harsh Environment

- Wide Operating Temperature Range:  $-40 \sim +75^{\circ}\text{C}$
- Storage Temperature:  $-40 \sim +85^{\circ}\text{C}$
- Humidity:  $10 \sim 90\% \text{ RH}$  (Non-condensing)

## 2. Hardware Information

### 2.1 Appearance

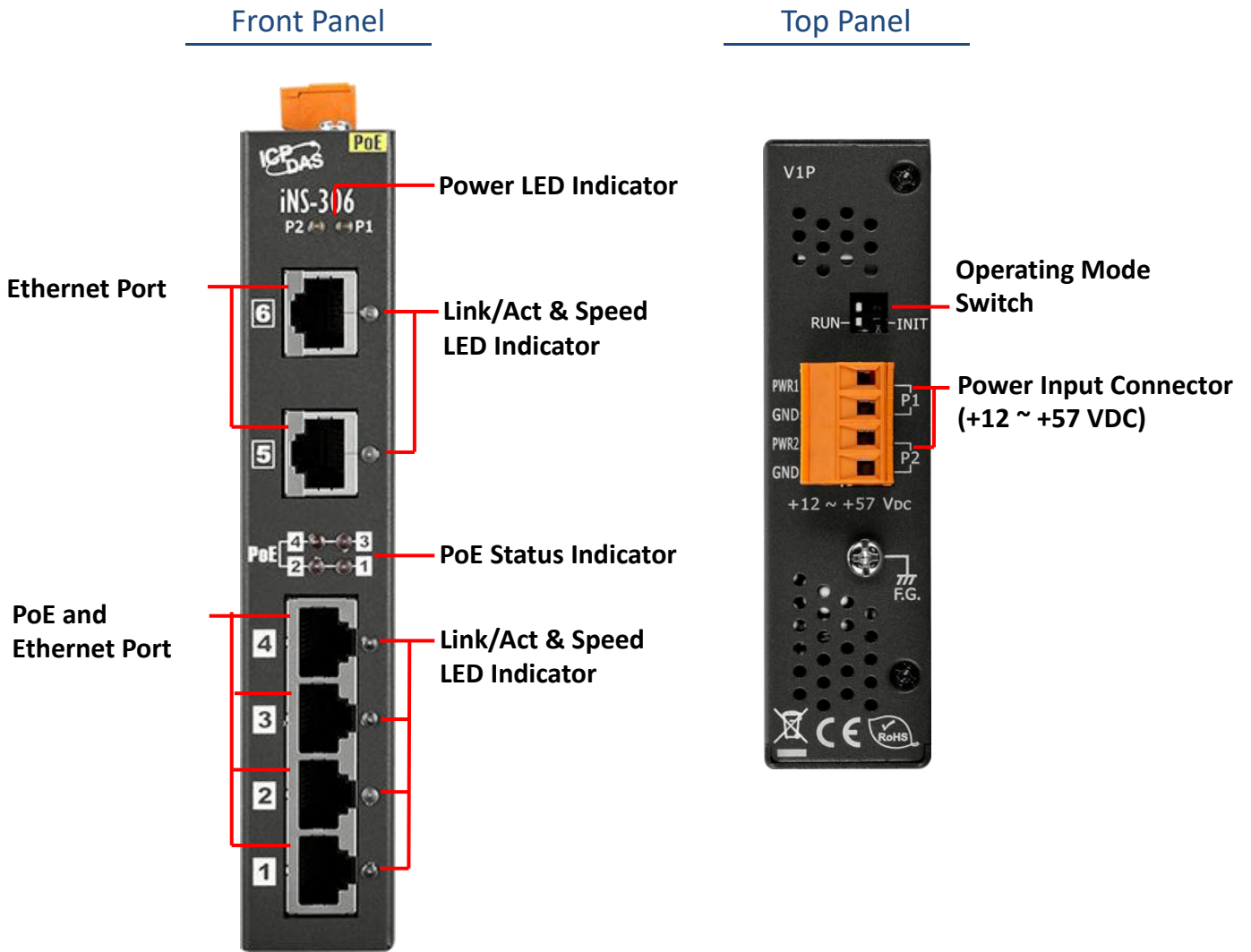

#### 1. Power LED Indicator

LED	Color	State	Description
P1	Yellow	On	Power is being supplied to power input PWR1.
		Off	Power is not being supplied to power input PWR1
P2	Yellow	On	Power is being supplied to power input PWR2.
		Off	Power is not being supplied to power input PWR2



## 2. Ethernet Port and Link/Act & Speed LED Indicator

The iNS-300 series modules are equipped with two RJ-45 10/100 Base-TX Ethernet ports. If the power to an iNS-300 series module is lost, the LAN bypass function will automatically activate. In other words, Port 5 and Port 6 will be bridged together to ensure network traffic availability.

LED Indicator	Color	State	Description
Port 5 ~ 6 Link/Act & speed	Amber	On	Link to 100 Mbps.
		Off	Link to 10 Mbps.
	Green	On	A link is present.
		Off	No link is present.

## 3. PoE Status Indicator

When a PoE-powered device is connected to a PoE port and receives its electrical power from the Ethernet cable, the corresponding status indicator will illuminate.

## 4. PoE and Ethernet Port and Link/Act & Speed LED Indicator

The iNS-300 series module offers 4 x 10/100Mbps PoE ports. Each port can provide up to 30 W of power (compliant with IEEE 802.3at standard). They can be used to connect and supply power to any PoE-enabled devices such as wireless access points, network cameras, IP phones, as well as to connect Ethernet-enabled devices like computers and printers.

LED Indicator	Color	State	Description
Port 1 ~ 4 Link/Act & speed	Amber	On	Link to 100 Mbps.
		Off	Link to 10 Mbps.
	Green	On	A link is present.
		Off	No link is present.

## 5. Operating Mode Switch

**INIT:** Use factory default settings for troubleshooting.

**RUN:** Use customer settings for normal operation.

## 6. Power Input Connector

The iNS-300 series module supports +12 to +57 V<sub>DC</sub> wide power input range and dual redundant power input to ensure stable operation in harsh environments. Once the power is supplied, the corresponding LED indicator lights up.

Each PoE port can provide up to 30 W of power when the the iNS-300 series module is powered by +24 ~ +57V<sub>DC</sub> power supply. If the iNS-300 series module is utilized under high load (total PoE load exceeds 60 W), it is recommended to configure dual power supplies.

---

## 2.2 Specification

<b>Model</b>	<b>iNS-306</b>
<b>PoE Technology</b>	
PoE Compliance	100% IEEE 802.3at compliant
PoE Power	Up to 30 watts per channel
PoE Operation	Automatic detection and power management
PoE Pin Assignments	V+ (pin 1, 2), V-(pin 3, 6)
PoE Disconnect Mode	DC disconnect
PoE Voltage	+52 VDC
<b>Ethernet</b>	
Ports	6 x RJ-45, 10/100Base-TX
Standards	IEEE 802.3 for 10 Base-T IEEE 802.3u for 100 Base-TX IEEE 802.3x for Flow Control, Back Pressure Flow Control IEEE 802.3af Power Over Ethernet IEEE 802.3at Power Over Ethernet Energy Efficient Ethernet (EEE) as per 802.3az; this provides power savings during idle network activity
Processing Type	Store & forward; wire speed switching
MAC Addresses	16K
Frame Buffer Memory	4Mbit
Isolation	1500 Vrms 1 minute
DIP Switch	Init
<b>LED Indicators</b>	
Status	PWR1, PWR2, POE, Link/Act, Speed
<b>Power</b>	
Reverse Polarity Protection	Yes
Input Range	12 ~ 57 VDC Redundant dual Input
Redundant Power Inputs	Yes
Consumption	0.15 A @ 24 VDC without PD loading, 6A @ 24VDC with PD full loading (30W per ports) 0.10 A @ 48 VDC without PD loading, 3A @ 48VDC with PD full loading (30W per ports)
<b>Mechanical</b>	
Casing	Metal
Dimensions (mm)	DIN-rail mounting: 28 x 160 x 119 (W x L x H) Wall mounting: 28 x 199 x 112 (W x L x H)
Installation	DIN-rail mounting or wall mounting (optional)
<b>Environmental</b>	
Operating Temperature	-40 °C ~ +75 °C
Storage Temperature	-40 °C ~ +85 °C
Humidity	10% ~ 90% RH, non-condensing

## 2.3 Dimensions

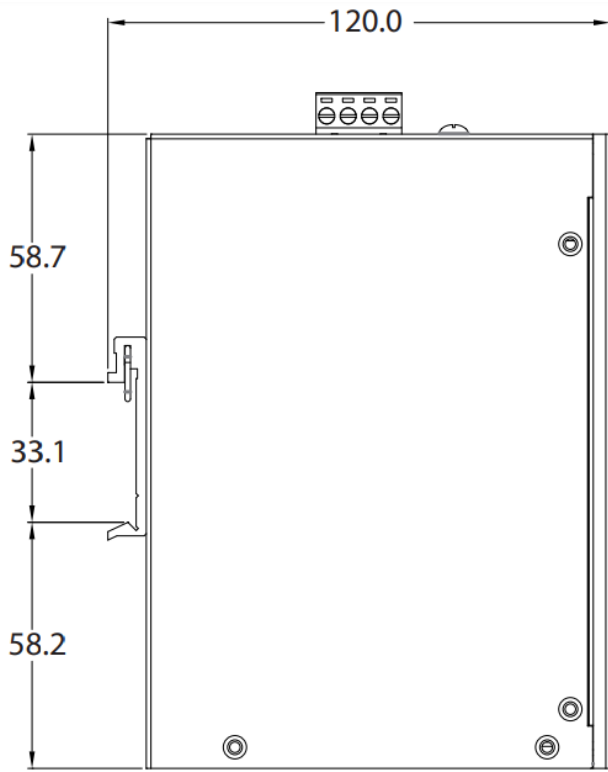

Left Side View

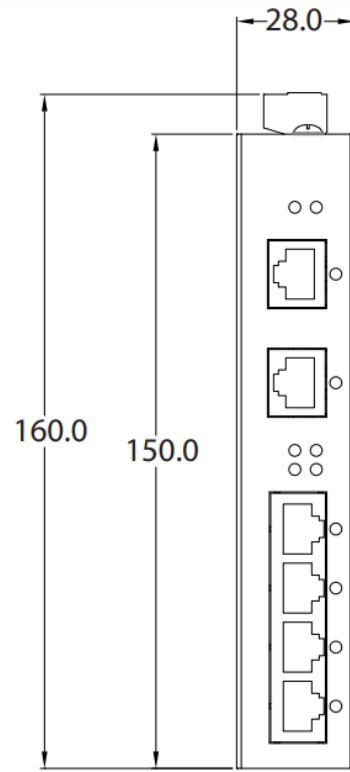

Front View

# 3. Getting Started

This chapter provides a basic overview of how to configure and operate the iNS-300 series module.

## 3.1 Configuring the Boot Mode

### ➤ INIT Mode

---

INIT mode is the initial mode used for troubleshooting only.

1. Put switch(1) in "INIT" position and then reboot the module to load factory settings.
2. Use **eSearch Utility** to reconfigure the module's network settings.
3. Put switch(1) back in RUN position and then reboot the module to work in normal mode.

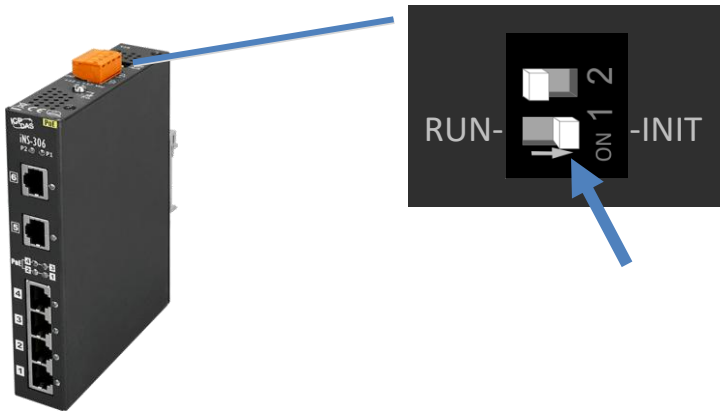

**⚠ Note** The module needs be rebooted after changing the operating mode switch.

### ➤ Run Mode

---

Run Mode is the default operating mode used for normal operation.

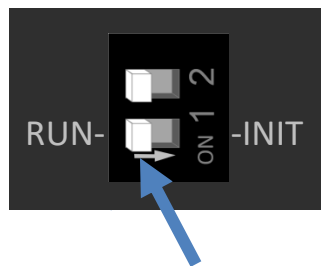

## 3.2 Connecting the Power and the Host PC

### Step 1: Connect both the iNS-300 series module and the Host PC to the same sub network.

Ensure that the network settings on the Host PC have been correctly configured and are functioning normally. Ensure that the Windows firewall or any Anti-Virus firewall is properly configured to allow incoming connections, or temporarily disable these functions, otherwise the **“Search Servers”** function in the eSearch Utility described in [Section 3.3 “Configuring the Network Settings”](#) may not perform as expected. Contact the System Administrator for instructions of how to do this.

### Step 2: Apply power (+12 ~ +57 V<sub>DC</sub>) to the iNS-300 series module.

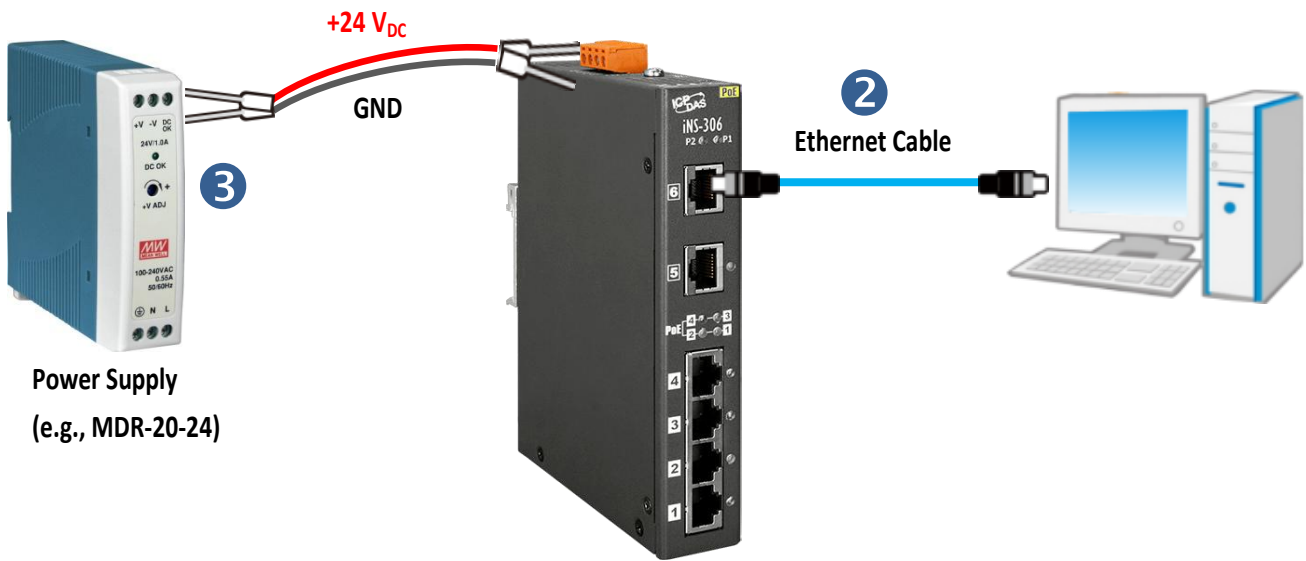

## 3.3 Configuring the Network Settings

### Step 1: Get the eSearch Utility

The eSearch Utility can be obtained from the ICP DAS Web site at:

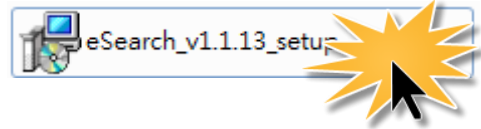

[https://www.icpdas.com/en/product/guide+Software+Utility\\_Driver+eSearch\\_Utility](https://www.icpdas.com/en/product/guide+Software+Utility_Driver+eSearch_Utility)

### Step 2: Install the eSearch Utility

Follow the instructions in the eSearch setup wizard to complete the installation.

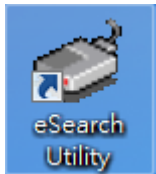
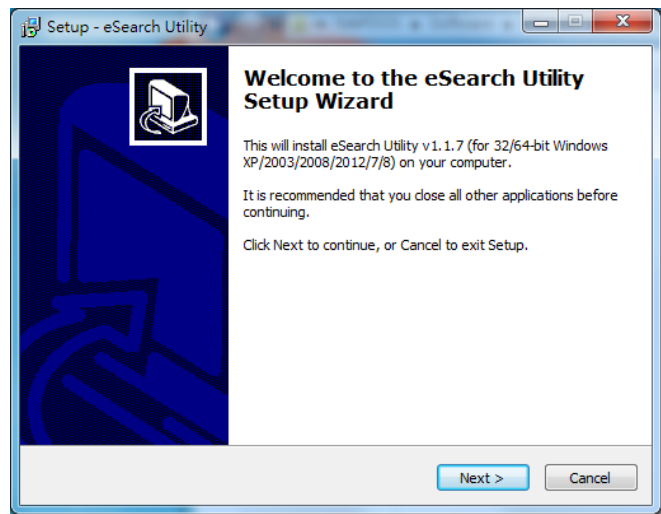

After the installation has been completed, a new short cut for the eSearch Utility will be displayed on your desktop

### Step 3: Click "Search Servers" to search for the iNS-300 series module on the network

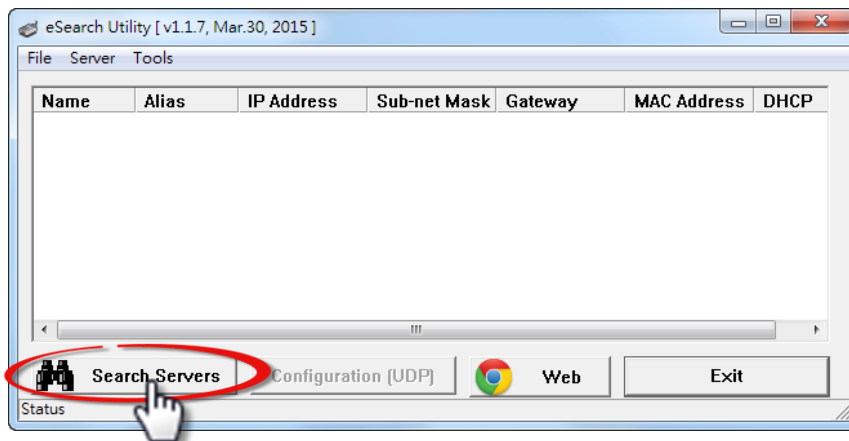

**Step 4: Double-click your module name to open the configuration dialog box**

**Factory Default Settings**

IP	192.168.255.1
Gateway	192.168.0.1
Mask	255.255.0.0

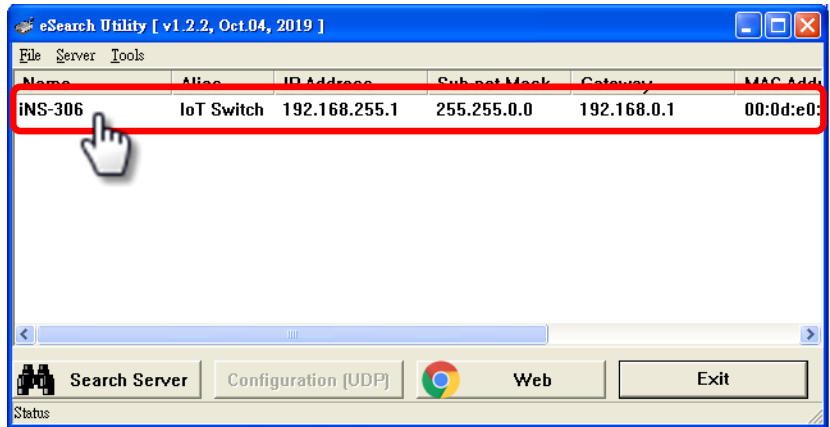

**Step 5: Assign new network settings and then click the “OK” button**

Enter the relevant values for the **IP Address**, **Subnet Mask**, **Gateway**, etc., and then click the **“OK”** button. The new settings will take effect within 2 seconds.

(Contact the Network Administrator to obtain the relevant details)

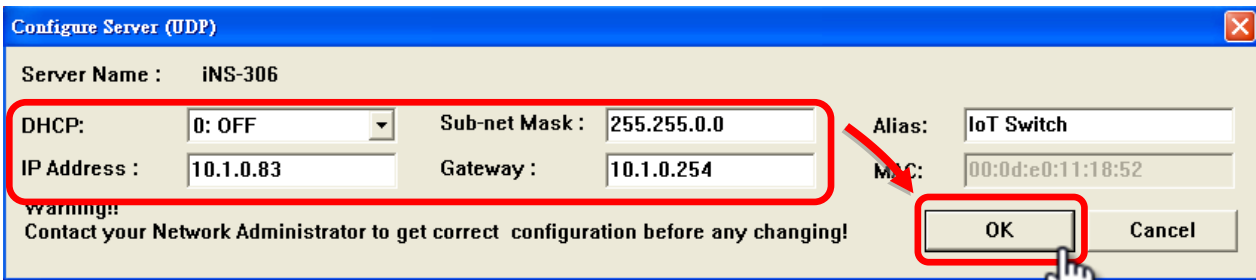

**Step 6: Wait for 2 seconds and then click “Search Servers” again to ensure that the module is functioning properly with new configuration.**

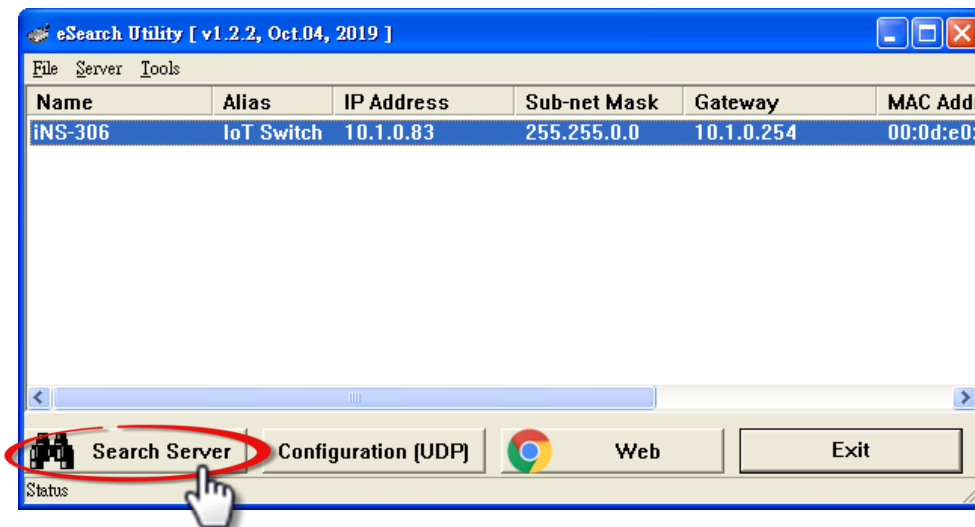



**Step 7: Click the “Web” button to connect to the web interface**

(Or entering the iNS-300's IP address into a web browser)

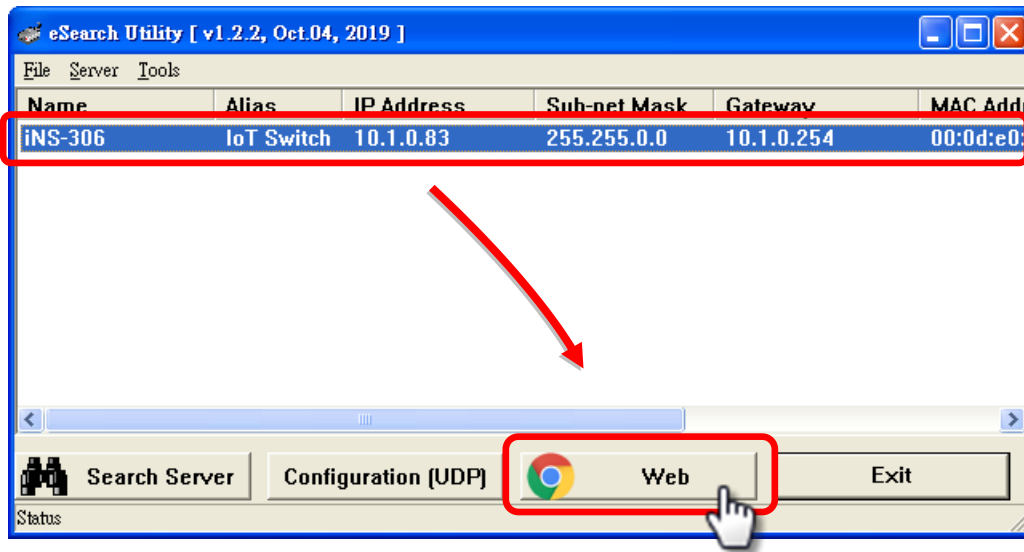

**Step 8: Change password upon first login**

The default password for logging in to the iNS-300 web page is **Admin**. You will be prompted to change your password upon first login or when the password is the same as the default. (Create a 1 to 12 character password using alphanumeric characters only.)



**IoT Switch**

[Home](#) | [Network](#) | [Schedule](#) | [Filter](#) | [Password](#) | [Logout](#)

**Change Password**

The length of the password is 12 characters maximum. Change-password is required if the current password is same as factory setting.

The form contains three input fields and a Submit button:

- 1. **Current password**: Input field with a red arrow pointing to it from the instruction "Enter Admin".
- 2. **New password**: Input field with a red arrow pointing to it from the instruction "Enter new password".
- 3. **Confirm new password**: Input field with a red arrow pointing to it from the instruction "Enter new password again".
- 4. **Submit**: Button with a red arrow pointing to it from the instruction "Click Submit".

# 4. Web Configuration

The iNS-300 series module has a built-in Web Server, which provides an intuitive web interface, allowing users to login to the module for monitoring the physical status of an Ethernet or PoE port, configuring and managing module settings through a browser.

## 4.1 Home

The **Home** page is the startup page when you log into the module. It displays detailed information about the module and the connection status and power consumption of the POE devices. You can turn on and off the PoE power, or enable/disable jumbo frame support here.

**IoT Switch**  
[Home](#) | [Next](#) | [Module](#) | [Filter](#) | [Password](#) | [Logout](#)

Model Name	iNS-306	Alias Name	IoT Switch
Firmware Version	v1.0.2 [Jul. 07 2021]	MAC Address	00-0D-E0-18-30-02
IP Address	10.1.0.59	Initial Switch	OFF
TCP Port Timeout (Socket Watchdog, Seconds)	180	Time	2021-7-9 10:30:20 / Firday

**Current Port State**

Port number	Link	PoE Enable	PoE power(W)
Port 1			1.1
Port 2			0.0
Port 3			0.0
Port 4			0.0
Port 5		-	-
Port 6		-	-











Advanced settings:

The first section provides basic information related to the module including the model name, firmware version, IP address, MAC address and so forth.

Model Name	iNS-306	Alias Name	IoT Switch
Firmware Version	v1.0.0 [Jan. 05 2021]	MAC Address	00-0D-E0-11-18-52
IP Address	10.1.0.83	Initial Switch	OFF
TCP Port Timeout (Socket Watchdog, Seconds)	180	Time	2021/1/28 17:43:3



The second section displays the connection status of each port and power consumption of the powered devices. You can manually power on or off the attached devices here.

**Current Port State**

Port number	Link	PoE Enable	PoE power(W)
Port 1:			1.10
Port 2:			0.0
Port 3:			0.0
Port 4:			0.0
Port 5:		-	-
Port 6:		-	-

**Advanced settings:**

	Current	Enable
Jumbo	0x0	<input type="checkbox"/>

Item	Description
Link	Displays the connection status of each port. A green light indicates that a device is connected to the port.
PoE Enable	Displays the power on/off status of a PoE port. You can click the power icon to turn on/off a PoE port.  The power on the PoE port is on  The power on the PoE port is off
PoE power(W)	The power consumption of connected PoE devices (unit: W)
Jumbo	Enable or disable Jumbo Frame support <b>Enable:</b> Max. Packets Size 16K <b>Disable:</b> Max. Packets Size 2K (Default)

## 4.2 Network

The Network page contains the IP Address Configuration section allowing you to verify network settings, General Settings, Restore Factory Defaults and Firmware Update sections. Each of which will be described in more detail below.

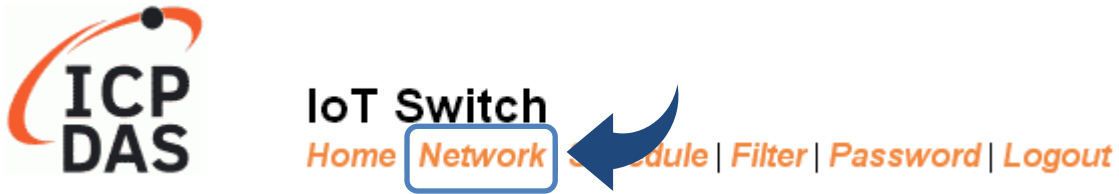

The IP Address Configuration section displays the network parameters of the module allowing you to modify these settings. You can select DHCP to receive a dynamic IP address from a DHCP server, or select static IP to manually assign an IP address to the module here.

### IP Address Configuration

<b>IP Address</b>	
Address Type	DHCP ▼
Static IP Address	255 . 255 . 255 . 255
Subnet Mask	0 . 0 . 0 . 0
Default Gateway	0 . 0 . 0 . 0
MAC Address	00-0D-E0-18-30-02 (Format: FF-FF-FF-FF-FF-FF)
Update Settings	

Item	Description
Address Type	<b>Static IP:</b> Manually set the IP Address, Subnet Mask and Default Gateway.
	<b>DHCP:</b> Using dynamic IP address that the DHCP server assigns.
Static IP Address	Enter an unique IP address on the network that the module is connected. This setting is available only when <b>Address Type</b> is Static IP enabled.
Subnet Mask	Enter a subnet mask. (Available only when Static IP is enabled.)
Default Gateway	Enter a default gateway. (Available only when Static IP is enabled.)
MAC Address	Enter a new MAC address if required. (Not recommended to modify.)
Update Settings	Click this button to update the revised settings.

### ➤ DHCP Configuration

If a DHCP server is connected to your network, a network address can be dynamically assigned by enabling DHCP client mode.

**Step 1:** Select “DHCP” from the **Address Type** drop-down menu.

**Step 2:** Click the “Update Settings” button to complete the configuration.

The screenshot shows a configuration form with the following fields and values:

Address Type	DHCP			
Static IP Address	10	0	8	100
Subnet Mask	255	255	255	0
Default Gateway	10	0	8	254
MAC Address	00-0d-e0-71-8d-01 (Format: FF-FF-FF-FF-FF-FF)			
Update Settings				

Annotations: A red circle with the number 1 is around the 'DHCP' dropdown. A red circle with the number 2 is around the 'Update Settings' button.

### ➤ Static IP Configuration

If Static IP is selected, you have to assign an IP address, a subnet mask and default gateway.

**Step 1:** Select “Static IP” from the **Address Type** drop-down menu.

**Step 2:** Enter the relevant details in the respective **network settings** fields.

**Step 3:** Click the “Update Settings” button to complete the configuration.

The screenshot shows a configuration form with the following fields and values:

Address Type	Static IP			
Static IP Address	10	0	8	100
Subnet Mask	255	255	255	0
Default Gateway	10	0	8	254
MAC Address	00-0d-e0-71-8d-01 (Format: FF-FF-FF-FF-FF-FF)			
Update Settings				

Annotations: A red circle with the number 1 is around the 'Static IP' dropdown. A red circle with the number 2 is around the 'Static IP Address' field. A red circle with the number 3 is around the 'Update Settings' button.

The General Settings section provides options for viewing and changing a variety of network settings, including Ethernet Speed, System Timeout, TCP Timeout, Web Auto-logout, etc.

### General Settings

System Timeout (Network Watchdog)	<input type="text" value="0"/> (30 ~ 65535 s, Default= 0, Disable= 0) Action:Reboot
TCP Timeout	<input type="text" value="180"/> (5 ~ 65535 s, Default= 180, Disable= 0) Action:Cut-off
UDP Configuration	Enable ▾ (Enable/Disable the UDP Configuration, Enable=default.)
Web Auto-logout	<input type="text" value="10"/> (1 ~ 65535 minutes, Default= 10, Disable= 0)
HTTP port	<input type="text" value="80"/> (Default= 80)
Alias Name	<input type="text" value="IoT Switch"/> (Max. 18 chars)
<input type="button" value="Update Settings"/>	

Item	Description
System Timeout (Network Watchdog)	Set the system timeout period. If the iNS-300 series is abnormally or connection failed due to unknown reason over the time set in this field, the system will be automatically restarted.
TCP Timeout	Set the TCP timeout period. If there is no traffic on the network over the time set in this field, the connection will be automatically closed.
UDP Configuration	Enable or disable the UDP configuration function.
Web Auto-logout	Set the automatic logout time. The user will be log out after the predetermined period of inactivity on web interface has elapsed.
Alias Name	Assign the alias name. Assigning a unique alias to each iNS-300 series module helps to identify multiple modules on the same network.
HTTP Port	Assign an HTTP port for the iNS-300 series module. The new setting will take effect after the module is restarted. The default value is 80. If a custom HTTP port is used, you have to add the port number after the IP address to connect the iNS-300 series module web interface. For example, enter “IP address: HTTP port” as “ <b>10.0.8.123:81</b> ” in your browser. <a href="#">( iNS-300’s IP address)</a>
Update Settings	Click this button to update the revised settings.

You can restore the iNS-300 series module to factory default settings or reboot it in the Other Operations section.

**Other Operations**

<b>Restore all options to their factory default states</b>	Restore Defaults
<b>Reboot the module</b>	Reboot
<b>Firmware update via Ethernet</b> If the remote firmware update is failed, then on-site firmware update is required to make the module working again. Step 1: Refer to firmware update manual first. Step 2: Run eSearch Utility to prepare and wait for update. Step 3: Click the [Update] button to <b>reboot</b> the module and start update. Step 4: Configure the module again.	Update

➤ **Restoring Factory Default Settings**

**Step 1:** Click the “Restore Defaults” button.

**Step 2:** Click “OK” on the pop-up dialog box.

**Step 3:** Search the iNS-300 series module in the eSearch Utility to confirm if the factory default settings have been restored. Refer to [Sec.3.3 Configuring the Network Settings](#) for more detailed information.

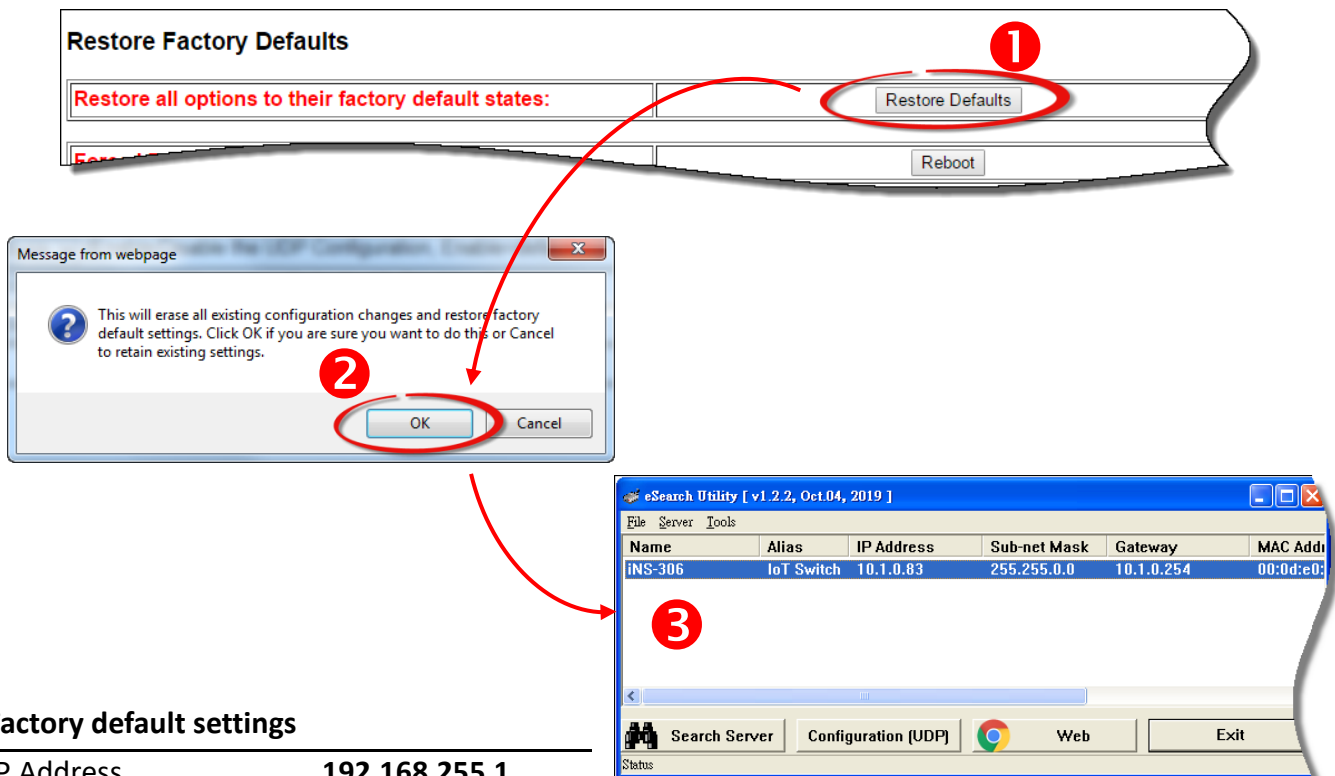

**Factory default settings**

IP Address	192.168.255.1
Gateway Address	192.168.0.1
Subnet Mask	255.255.0.0

## ➤ Rebooting the Module

**Step 1:** Click the **“Reboot”** button in the right field of Force Reboot.

**Step 2:** After the module restarts, reload the web interface and log into the module again.

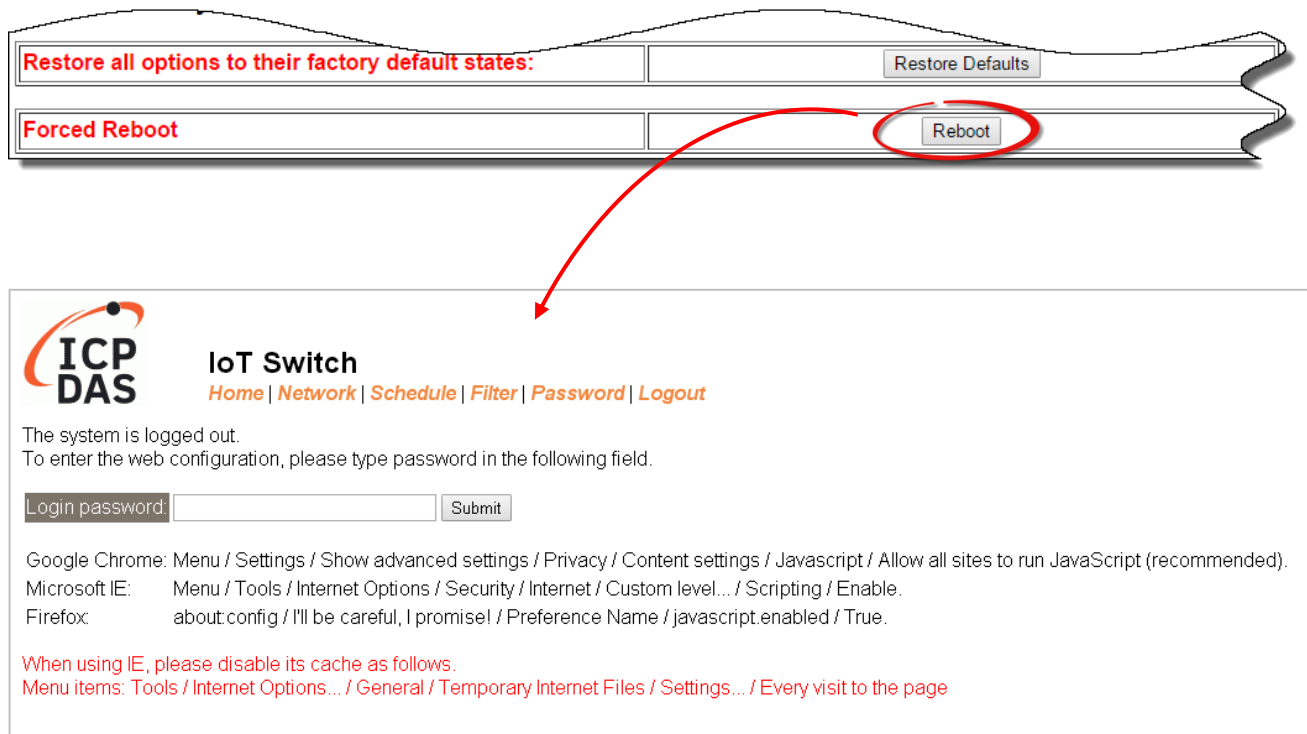



## ➤ Updating Firmware

Generally, you have to manually put the operating mode switch(1) in INIT position and reboot the iNS-300 series module to update the firmware. But when the iNS-300 series module is deployed on the ceiling or in areas that are isolated and hard to reach, you can update firmware by clicking the **“Reboot”** button in the Firmware Update section via the network without manual adjustment.

### Firmware Update

**If the remote firmware update is failed, then the traditional firmware update (on-site) is required to make the module working again.**

- Step 1: Refer to firmware update manual first.
- Step 2: Run eSearch Utility to prepare and wait for update.
- Step 3: Click the [Update] button to **reboot** the module and start update.
- Step 4: Configure the module again.



Note that the iNS-300 series module needs to be connected to the same network as your computer. If not, using remote desktop software like TeamViewer to access to a computer connected to the same network of the iNS-300 series module, you can remotely update firmware in the same way.

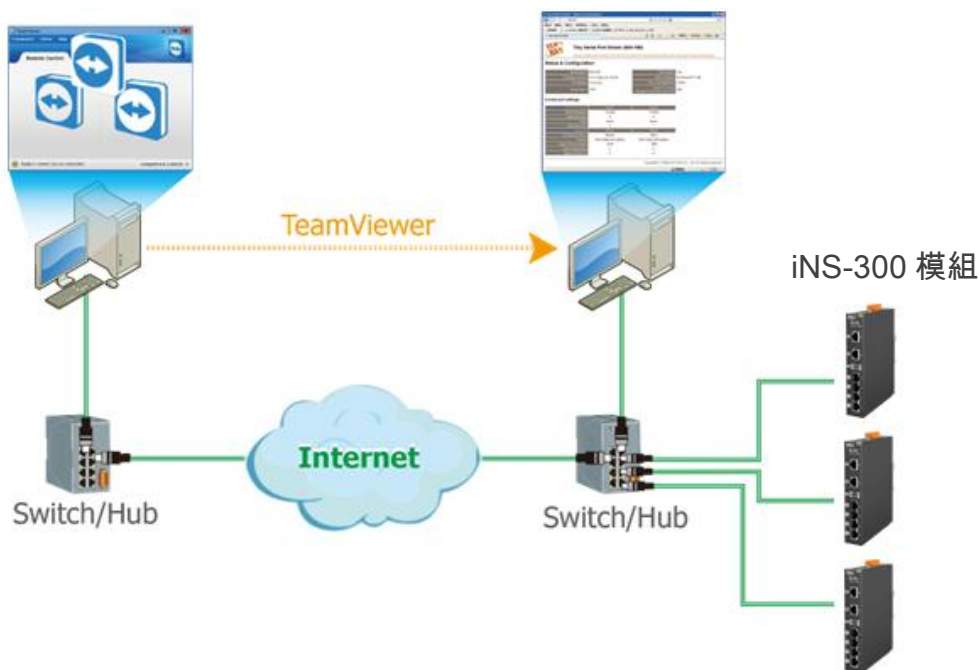

**⚠ Note** If the remote firmware update fails, the module will not work properly. It is necessary to manually update the firmware for the module to function correctly.

## 4.3 Schedule

On the Schedule page, you can set the system time (RTC), NTP server, and manage the power schedule for PoE powered device(s).



### ➤ Setting the system time

Correct system time is essential to network communication and PoE power management. Configure the system time correctly before you run the module on the network.

#### Real Time Clock:

#	
Date / Time	年 / 月 / 日 -- -- : : : : : :
<input type="button" value="Submit"/>	

**Step 1:** Click the calendar icon and select the correct time in the pop up dialog field.

#																																																																														
Date / Time	年 / 月 / 日 -- -- : : : : : :																																																																													
<div style="display: flex; align-items: flex-start;"><div style="margin-right: 10px;"><p>2021年07月 ▾    ↑    ↓</p><table border="1"><thead><tr><th>日</th><th>一</th><th>二</th><th>三</th><th>四</th><th>五</th><th>六</th></tr></thead><tbody><tr><td>27</td><td>28</td><td>29</td><td>30</td><td>1</td><td>2</td><td>3</td></tr><tr><td>4</td><td>5</td><td>6</td><td>7</td><td>8</td><td>9</td><td>10</td></tr><tr><td>11</td><td>12</td><td>13</td><td>14</td><td>15</td><td>16</td><td>17</td></tr><tr><td>18</td><td>19</td><td>20</td><td>21</td><td>22</td><td>23</td><td>24</td></tr><tr><td>25</td><td>26</td><td>27</td><td>28</td><td style="background-color: #007bff; color: white;">29</td><td>30</td><td>31</td></tr><tr><td>1</td><td>2</td><td>3</td><td>4</td><td>5</td><td>6</td><td>7</td></tr></tbody></table><p style="text-align: right;">今天</p></div><div style="border: 1px solid #ccc; padding: 5px;"><table border="1"><tbody><tr><td style="background-color: #007bff; color: white;">04</td><td style="background-color: #007bff; color: white;">32</td><td style="background-color: #007bff; color: white;">25</td><td style="background-color: #007bff; color: white;">下午</td></tr><tr><td>05</td><td>33</td><td>26</td><td>上午</td></tr><tr><td>06</td><td>34</td><td>27</td><td></td></tr><tr><td>07</td><td>35</td><td>28</td><td></td></tr><tr><td>08</td><td>36</td><td>29</td><td></td></tr><tr><td>09</td><td>37</td><td>30</td><td></td></tr><tr><td>10</td><td>38</td><td>31</td><td></td></tr></tbody></table></div></div>		日	一	二	三	四	五	六	27	28	29	30	1	2	3	4	5	6	7	8	9	10	11	12	13	14	15	16	17	18	19	20	21	22	23	24	25	26	27	28	29	30	31	1	2	3	4	5	6	7	04	32	25	下午	05	33	26	上午	06	34	27		07	35	28		08	36	29		09	37	30		10	38	31	
日	一	二	三	四	五	六																																																																								
27	28	29	30	1	2	3																																																																								
4	5	6	7	8	9	10																																																																								
11	12	13	14	15	16	17																																																																								
18	19	20	21	22	23	24																																																																								
25	26	27	28	29	30	31																																																																								
1	2	3	4	5	6	7																																																																								
04	32	25	下午																																																																											
05	33	26	上午																																																																											
06	34	27																																																																												
07	35	28																																																																												
08	36	29																																																																												
09	37	30																																																																												
10	38	31																																																																												

**Step 2:** confirm the date and time, and click “**Submit**” to update the system time.

#	
Date / Time	2021/07/29 下午 04:32:25 
<input type="button" value="Submit"/>	

➤ Time synchronization with NTP

NTP (network time protocol) is a protocol designed to synchronize time over the network. In the NTP section, you can enable or disable the NTP client function, specify an NTP server for clock synchronization and set the time zone.

 **Note** Once the NTP function is enabled, the iNS-300 series module will only synchronize its clock time every hour on the hour.

**NTP:**

State	Disable ▾
Time Zone	8 (-12 to 14)
IP address or Host Name	time.google.com (default : time.google.com)
<input type="button" value="Submit"/>	

Item	Description
State	Disable: Disable the NTP synchronization (Default) Enable: Enable the NTP synchronization
Time Zone	Enter the time zone.
IP address or Host Name	Enter the IP address (IPv4) or hostname of the NTP server.
Submit	Click this button to update the revised settings.

➤ Reset schedule for automatic reboot of PoE devices

In order to keep the PoE powered devices functioning in good condition, restarting the devices regularly will help. You can configure a weekly schedule for each PoE port individually to reboot the attached devices. The iNS-300 will check the schedule every hour on the hour. If the checkbox for reset function is selected, the power on a POE port will be turned off and then turned on again after a specified time interval.

 **Note:** This function is only valid when the power status of the PoE port is ON.

Step 1: Click the PoE port name to display its schedule page.

Step 2: Set the period between turning off the PoE power and turning it back on again.

Step 3: Click the small box for enabling or disabling the reset function at specified times.

Red box  indicates enabling , while gray box  indicates disabling the function.

Click **All on** can set all items enabled, and click **All off** can set all items disabled in a day.

Step 4: Click “**Submit**” to update the revised settings.

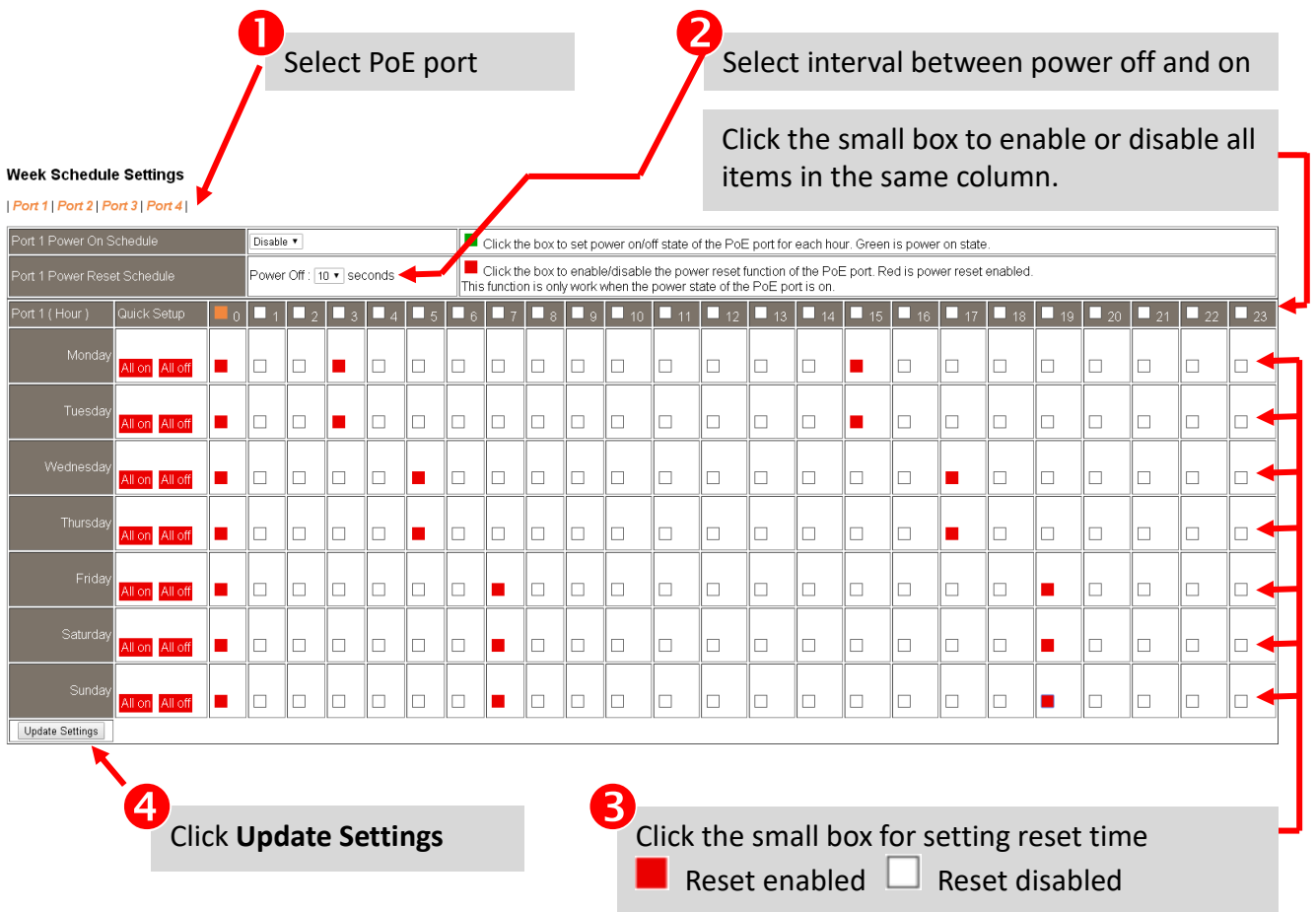

**Week Schedule Settings**  
 | Port 1 | Port 2 | Port 3 | Port 4 |

Port 1 Power On Schedule:   Click the box to set power on/off state of the PoE port for each hour. Green is power on state.

Port 1 Power Reset Schedule: Power Off:  seconds  Click the box to enable/disable the power reset function of the PoE port. Red is power reset enabled. This function is only work when the power state of the PoE port is on.

Port 1 (Hour)	Quick Setup	0	1	2	3	4	5	6	7	8	9	10	11	12	13	14	15	16	17	18	19	20	21	22	23
Monday	<input checked="" type="checkbox"/> All on <input checked="" type="checkbox"/> All off	<input checked="" type="checkbox"/>	<input type="checkbox"/>	<input type="checkbox"/>	<input checked="" type="checkbox"/>	<input type="checkbox"/>	<input type="checkbox"/>	<input type="checkbox"/>	<input type="checkbox"/>	<input type="checkbox"/>	<input type="checkbox"/>	<input type="checkbox"/>	<input type="checkbox"/>	<input type="checkbox"/>	<input type="checkbox"/>	<input type="checkbox"/>	<input checked="" type="checkbox"/>	<input type="checkbox"/>	<input type="checkbox"/>	<input type="checkbox"/>	<input type="checkbox"/>	<input type="checkbox"/>	<input type="checkbox"/>	<input type="checkbox"/>	<input type="checkbox"/>
Tuesday	<input checked="" type="checkbox"/> All on <input checked="" type="checkbox"/> All off	<input checked="" type="checkbox"/>	<input type="checkbox"/>	<input type="checkbox"/>	<input checked="" type="checkbox"/>	<input type="checkbox"/>	<input type="checkbox"/>	<input type="checkbox"/>	<input type="checkbox"/>	<input type="checkbox"/>	<input type="checkbox"/>	<input type="checkbox"/>	<input type="checkbox"/>	<input type="checkbox"/>	<input type="checkbox"/>	<input type="checkbox"/>	<input checked="" type="checkbox"/>	<input type="checkbox"/>	<input type="checkbox"/>	<input type="checkbox"/>	<input type="checkbox"/>	<input type="checkbox"/>	<input type="checkbox"/>	<input type="checkbox"/>	<input type="checkbox"/>
Wednesday	<input checked="" type="checkbox"/> All on <input checked="" type="checkbox"/> All off	<input checked="" type="checkbox"/>	<input type="checkbox"/>	<input type="checkbox"/>	<input type="checkbox"/>	<input type="checkbox"/>	<input checked="" type="checkbox"/>	<input type="checkbox"/>	<input type="checkbox"/>	<input type="checkbox"/>	<input type="checkbox"/>	<input type="checkbox"/>	<input type="checkbox"/>	<input type="checkbox"/>	<input type="checkbox"/>	<input type="checkbox"/>	<input type="checkbox"/>	<input checked="" type="checkbox"/>	<input type="checkbox"/>	<input type="checkbox"/>	<input type="checkbox"/>	<input type="checkbox"/>	<input type="checkbox"/>	<input type="checkbox"/>	<input type="checkbox"/>
Thursday	<input checked="" type="checkbox"/> All on <input checked="" type="checkbox"/> All off	<input checked="" type="checkbox"/>	<input type="checkbox"/>	<input type="checkbox"/>	<input type="checkbox"/>	<input type="checkbox"/>	<input checked="" type="checkbox"/>	<input type="checkbox"/>	<input type="checkbox"/>	<input type="checkbox"/>	<input type="checkbox"/>	<input type="checkbox"/>	<input type="checkbox"/>	<input type="checkbox"/>	<input type="checkbox"/>	<input type="checkbox"/>	<input type="checkbox"/>	<input checked="" type="checkbox"/>	<input type="checkbox"/>	<input type="checkbox"/>	<input type="checkbox"/>	<input type="checkbox"/>	<input type="checkbox"/>	<input type="checkbox"/>	<input type="checkbox"/>
Friday	<input checked="" type="checkbox"/> All on <input checked="" type="checkbox"/> All off	<input checked="" type="checkbox"/>	<input type="checkbox"/>	<input type="checkbox"/>	<input type="checkbox"/>	<input type="checkbox"/>	<input type="checkbox"/>	<input checked="" type="checkbox"/>	<input type="checkbox"/>	<input type="checkbox"/>	<input type="checkbox"/>	<input type="checkbox"/>	<input type="checkbox"/>	<input type="checkbox"/>	<input type="checkbox"/>	<input type="checkbox"/>	<input type="checkbox"/>	<input type="checkbox"/>	<input type="checkbox"/>	<input checked="" type="checkbox"/>	<input type="checkbox"/>	<input type="checkbox"/>	<input type="checkbox"/>	<input type="checkbox"/>	<input type="checkbox"/>
Saturday	<input checked="" type="checkbox"/> All on <input checked="" type="checkbox"/> All off	<input checked="" type="checkbox"/>	<input type="checkbox"/>	<input type="checkbox"/>	<input type="checkbox"/>	<input type="checkbox"/>	<input type="checkbox"/>	<input checked="" type="checkbox"/>	<input type="checkbox"/>	<input type="checkbox"/>	<input type="checkbox"/>	<input type="checkbox"/>	<input type="checkbox"/>	<input type="checkbox"/>	<input type="checkbox"/>	<input type="checkbox"/>	<input type="checkbox"/>	<input type="checkbox"/>	<input type="checkbox"/>	<input checked="" type="checkbox"/>	<input type="checkbox"/>	<input type="checkbox"/>	<input type="checkbox"/>	<input type="checkbox"/>	<input type="checkbox"/>
Sunday	<input checked="" type="checkbox"/> All on <input checked="" type="checkbox"/> All off	<input checked="" type="checkbox"/>	<input type="checkbox"/>	<input type="checkbox"/>	<input type="checkbox"/>	<input type="checkbox"/>	<input type="checkbox"/>	<input checked="" type="checkbox"/>	<input type="checkbox"/>	<input type="checkbox"/>	<input type="checkbox"/>	<input type="checkbox"/>	<input type="checkbox"/>	<input type="checkbox"/>	<input type="checkbox"/>	<input type="checkbox"/>	<input type="checkbox"/>	<input type="checkbox"/>	<input type="checkbox"/>	<input checked="" type="checkbox"/>	<input type="checkbox"/>	<input type="checkbox"/>	<input type="checkbox"/>	<input type="checkbox"/>	<input type="checkbox"/>

**1** Select PoE port

**2** Select interval between power off and on

Click the small box to enable or disable all items in the same column.

**3** Click the small box for setting reset time  
 Reset enabled  Reset disabled

**4** Click **Update Settings**

➤ Power schedule for turning on/off PoE devices

The 4 PoE ports of the iNS-300 can be individually scheduled to automate shut down and restart PoE powered devices at specified times in a day or week. It is helpful for realizing remote management and saving manpower and power consumption.

**⚠ Note:** The PoE power will check the power schedule, turn on/off the powered devices every hour on the hour.

Step 1: Click the PoE port name to display its schedule page.

Step 2: Select **[Enable]** to enable or **[Disable]** to disable the power schedule.

Step 3: Click the small box for powering on or off the powered device at specified times.

Green box  indicates turning on , while gray box  indicates turning off.

Click **All on** can set all items on, and click **All off** can set all items off in a day.

Step 4: Click “**Submit**” to update the revised settings.

**Week Schedule Settings**  
 | Port 1 | Port 2 | Port 3 | Port 4 |

Port 1 Power On Schedule:  Click the box to set power on/off state of the PoE port for each hour. Green is power on state.

Port 1 Power Reset Schedule: Power Off: 10 seconds Click the box to enable/disable the power reset function of the PoE port. Red is power reset enabled. This function is only work when the power state of the PoE port is on.

Port 1 ( Hour )	Quick Setup	0	1	2	3	4	5	6	7	8	9	10	11	12	13	14	15	16	17	18	19	20	21	22	23
Monday	All on All off	<input checked="" type="checkbox"/>	<input checked="" type="checkbox"/>	<input checked="" type="checkbox"/>	<input checked="" type="checkbox"/>	<input checked="" type="checkbox"/>	<input checked="" type="checkbox"/>	<input checked="" type="checkbox"/>	<input checked="" type="checkbox"/>	<input checked="" type="checkbox"/>	<input checked="" type="checkbox"/>	<input checked="" type="checkbox"/>	<input checked="" type="checkbox"/>	<input checked="" type="checkbox"/>	<input checked="" type="checkbox"/>	<input checked="" type="checkbox"/>	<input checked="" type="checkbox"/>	<input checked="" type="checkbox"/>	<input checked="" type="checkbox"/>	<input checked="" type="checkbox"/>	<input checked="" type="checkbox"/>	<input checked="" type="checkbox"/>	<input checked="" type="checkbox"/>	<input checked="" type="checkbox"/>	<input checked="" type="checkbox"/>
Tuesday	All on All off	<input checked="" type="checkbox"/>	<input checked="" type="checkbox"/>	<input checked="" type="checkbox"/>	<input checked="" type="checkbox"/>	<input checked="" type="checkbox"/>	<input checked="" type="checkbox"/>	<input checked="" type="checkbox"/>	<input checked="" type="checkbox"/>	<input checked="" type="checkbox"/>	<input checked="" type="checkbox"/>	<input checked="" type="checkbox"/>	<input checked="" type="checkbox"/>	<input checked="" type="checkbox"/>	<input checked="" type="checkbox"/>	<input checked="" type="checkbox"/>	<input checked="" type="checkbox"/>	<input checked="" type="checkbox"/>	<input checked="" type="checkbox"/>	<input checked="" type="checkbox"/>	<input checked="" type="checkbox"/>	<input checked="" type="checkbox"/>	<input checked="" type="checkbox"/>	<input checked="" type="checkbox"/>	<input checked="" type="checkbox"/>
Wednesday	All on All off	<input checked="" type="checkbox"/>	<input checked="" type="checkbox"/>	<input checked="" type="checkbox"/>	<input checked="" type="checkbox"/>	<input checked="" type="checkbox"/>	<input checked="" type="checkbox"/>	<input checked="" type="checkbox"/>	<input checked="" type="checkbox"/>	<input checked="" type="checkbox"/>	<input checked="" type="checkbox"/>	<input checked="" type="checkbox"/>	<input checked="" type="checkbox"/>	<input checked="" type="checkbox"/>	<input checked="" type="checkbox"/>	<input checked="" type="checkbox"/>	<input checked="" type="checkbox"/>	<input checked="" type="checkbox"/>	<input checked="" type="checkbox"/>	<input checked="" type="checkbox"/>	<input checked="" type="checkbox"/>	<input checked="" type="checkbox"/>	<input checked="" type="checkbox"/>	<input checked="" type="checkbox"/>	<input checked="" type="checkbox"/>
Thursday	All on All off	<input checked="" type="checkbox"/>	<input checked="" type="checkbox"/>	<input checked="" type="checkbox"/>	<input checked="" type="checkbox"/>	<input checked="" type="checkbox"/>	<input checked="" type="checkbox"/>	<input checked="" type="checkbox"/>	<input checked="" type="checkbox"/>	<input checked="" type="checkbox"/>	<input checked="" type="checkbox"/>	<input checked="" type="checkbox"/>	<input checked="" type="checkbox"/>	<input checked="" type="checkbox"/>	<input checked="" type="checkbox"/>	<input checked="" type="checkbox"/>	<input checked="" type="checkbox"/>	<input checked="" type="checkbox"/>	<input checked="" type="checkbox"/>	<input checked="" type="checkbox"/>	<input checked="" type="checkbox"/>	<input checked="" type="checkbox"/>	<input checked="" type="checkbox"/>	<input checked="" type="checkbox"/>	<input checked="" type="checkbox"/>
Friday	All on All off	<input checked="" type="checkbox"/>	<input checked="" type="checkbox"/>	<input checked="" type="checkbox"/>	<input checked="" type="checkbox"/>	<input checked="" type="checkbox"/>	<input checked="" type="checkbox"/>	<input checked="" type="checkbox"/>	<input checked="" type="checkbox"/>	<input checked="" type="checkbox"/>	<input checked="" type="checkbox"/>	<input checked="" type="checkbox"/>	<input checked="" type="checkbox"/>	<input checked="" type="checkbox"/>	<input checked="" type="checkbox"/>	<input checked="" type="checkbox"/>	<input checked="" type="checkbox"/>	<input checked="" type="checkbox"/>	<input checked="" type="checkbox"/>	<input checked="" type="checkbox"/>	<input checked="" type="checkbox"/>	<input checked="" type="checkbox"/>	<input checked="" type="checkbox"/>	<input checked="" type="checkbox"/>	<input checked="" type="checkbox"/>
Saturday	All on All off	<input checked="" type="checkbox"/>	<input checked="" type="checkbox"/>	<input checked="" type="checkbox"/>	<input checked="" type="checkbox"/>	<input checked="" type="checkbox"/>	<input checked="" type="checkbox"/>	<input checked="" type="checkbox"/>	<input checked="" type="checkbox"/>	<input checked="" type="checkbox"/>	<input checked="" type="checkbox"/>	<input checked="" type="checkbox"/>	<input checked="" type="checkbox"/>	<input checked="" type="checkbox"/>	<input checked="" type="checkbox"/>	<input checked="" type="checkbox"/>	<input checked="" type="checkbox"/>	<input checked="" type="checkbox"/>	<input checked="" type="checkbox"/>	<input checked="" type="checkbox"/>	<input checked="" type="checkbox"/>	<input checked="" type="checkbox"/>	<input checked="" type="checkbox"/>	<input checked="" type="checkbox"/>	<input checked="" type="checkbox"/>
Sunday	All on All off	<input checked="" type="checkbox"/>	<input checked="" type="checkbox"/>	<input checked="" type="checkbox"/>	<input checked="" type="checkbox"/>	<input checked="" type="checkbox"/>	<input checked="" type="checkbox"/>	<input checked="" type="checkbox"/>	<input checked="" type="checkbox"/>	<input checked="" type="checkbox"/>	<input checked="" type="checkbox"/>	<input checked="" type="checkbox"/>	<input checked="" type="checkbox"/>	<input checked="" type="checkbox"/>	<input checked="" type="checkbox"/>	<input checked="" type="checkbox"/>	<input checked="" type="checkbox"/>	<input checked="" type="checkbox"/>	<input checked="" type="checkbox"/>	<input checked="" type="checkbox"/>	<input checked="" type="checkbox"/>	<input checked="" type="checkbox"/>	<input checked="" type="checkbox"/>	<input checked="" type="checkbox"/>	<input checked="" type="checkbox"/>

## 4.4 Filter

The Filter page is used to query or edit the IP Filter list (Allow IP List) for the iNS-300 series module. The IP filter list restricts the access of incoming packets based on the IP address. If one or more IP addresses are saved into the **Allow IP List**, only clients that have an IP address within the filter list can access the iNS-300 series module.



IoT Switch

Home | Network | Schedule | **Filter** | Password | Logout

### Filter Settings:

Allow IP List	IP Address
IP1:	0.0.0.0
IP2:	0.0.0.0
IP3:	0.0.0.0
IP4:	0.0.0.0
IP5:	0.0.0.0

Add  .  .  .  To The List

Delete IP#

Delete ALL

Save to Flash

Item	Description
Add "IP" to the List	Enter the new IP address to the Allow IP List.
Delete IP #	Enter the IP# (number = 1 ~ 5) to delete the IP address from the Allow IP List.
Delete All	Delete all IP addresses contained in the Allow IP List.
Save to Flash	Check the checkbox before clicking " <b>Submit</b> " to save the content within Allow IP List to the Flash memory.
Submit	Click this button to apply the revised settings.

## 4.5 Changing Password



### IoT Switch

[Home](#) | [Network](#) | [Schedule](#) | [Filter](#) | **[Password](#)** | [Logout](#)



You can change password on the **Password** page.

Step 1: Enter your current password in the **“Current password”** field.

Step 2: Enter your new password in the **“New password”** field.

(1 ~ 12 alphanumeric characters are allowed)

Step 3: Enter your new password in the **“Confirm new password”** field.

Step 4: click the **“Submit”** button to update the password.

#### Change Password

The length of the password is 12 characters maximum.

Current password:	<input type="password" value="....."/>
New password:	<input type="password" value="...."/>
Confirm new password:	<input type="password" value="...."/>
	<input type="button" value="Submit"/>

## 4.6 Logout



Click “**Logout**” on the navigation bar to log out of your account. It redirects you to the login page

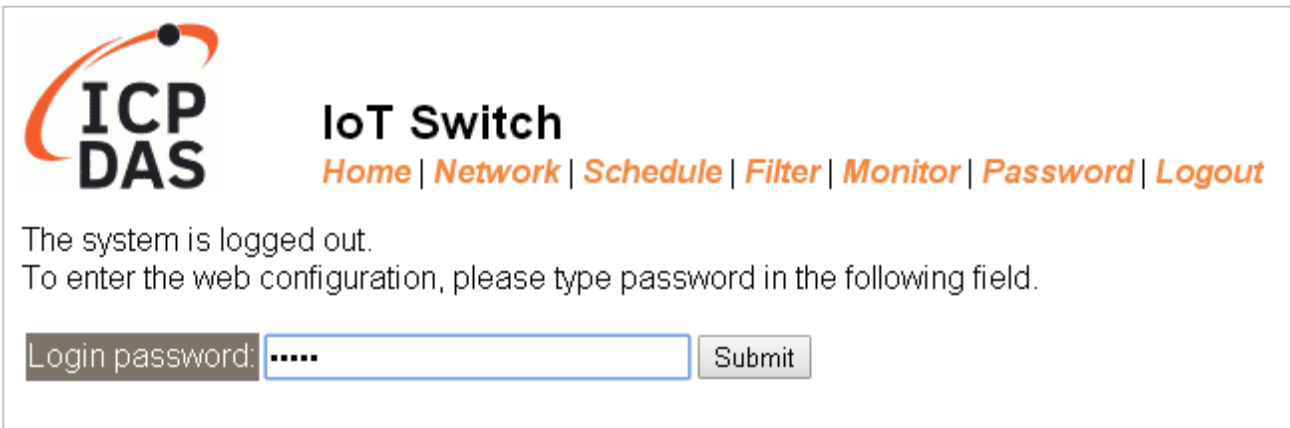



# Revision History

Revision	Date	Description
1.0.0	Oct. 2021	Initial issue