



I/O CARD QUICK START GUIDE

for

DIO-48

Language
Version
Update

English
V1.3
Jun.2009

1

What's in your package?

- One DIO-48 series card
- One companion ISA CD (V2.1 or later)
- One Quick Start Guide (This document)

2

Installing Windows Driver

Follow these steps:

1. Setup the Windows driver.





The driver is location at:

CD:\NAPDOS\ISA\DIO\DLL\

<http://ftp.icpdas.com/pub/cd/iocard/isa/napdos/isa/dio/dll/>



The Windows driver only supports Windows 98/NT/2000 and XP/2003/vista 32-bit versions.

2. Click the  button to start the installation.
3. Click the  button to install the driver into the default folder.
4. Click the  button to continue the installation.
5. Select the “**NO, I will restart my computer later**” and then click the  button.

3

I/O Base Address & Interrupt Setting

- The base address is set from SW1 DIP switch on board: (Default setting for 2C0)

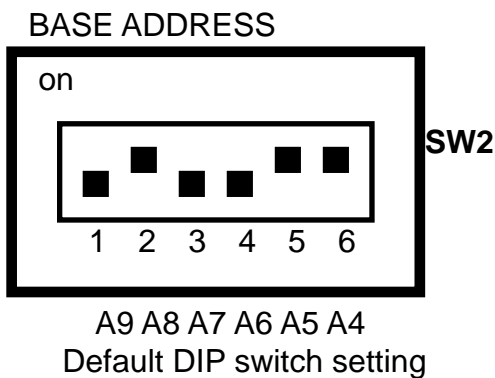

I/O Address	1 A9	2 A8	3 A7	4 A6	5 A5	6 A4
200-20F	Off	On	On	On	On	On
210-21F	Off	On	On	On	On	Off
.....						
2C0-2CF (Default)	Off	On	Off	Off	On	On
.....						
3F0-3FF	Off	Off	Off	Off	Off	Off

- Interrupt jumper setting

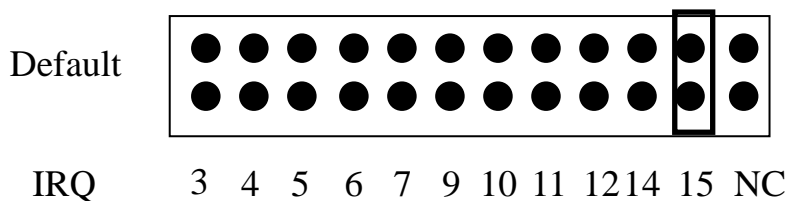

4

Installing Hardware on PC

Follow these steps:

1. Shut down and power off your computer.
2. Remove the cover from the computer.
3. Select an unused ISA slot.
4. Carefully insert your I/O card into the ISA slot.
5. Replace the PC cover.
6. Power on the computer.

After powering-on the computer, continue next process.

5

Adding Hardware



Adding hardware is used on Windows 2000/XP/2003/Vista 32 only. Windows 9X/Me/NT users can skip it.

7. Add Hardware

- 7-1 Open the **“Control Panel”** by click the item **“Start / Settings / Control Panel”**.
- 7-2 Double-click the item **“Add/Remove Hardware”** and Click the **“Next >”** button.
- 7-3 Select the item **“Add/Troubleshoot a device”** and click the **“Next >”** button.
- 7-4 Select the item **“Add a new device”** and click the **“Next >”** button.

- 7-5 Select the item **“No, I want to select the hardware from a list”** and click the **“Next >”** button.
- 7-6 Select the item **“Other device”** and click the **“Next >”** button.
- 7-7 Click the **“Have Disk...”** button.
- 7-8 Click the **“Browse...”** button to select the **Inf** file default path is C:\DAQPRO\DIO_Win2K\Inf and click the **“OK”** button.
- 7-9 Select the correct device from the **“Models:”** listbox and Click the **“Next >”** button.
- 7-10 The windows show to dialog box and Click the **“OK”** button to enter the device’s properties settings.

8. Modify the device properties.

The image shows three screenshots of Windows device property dialog boxes for an ICPDAS DIO-48 Digital I/O Card. The first screenshot is the 'Resources' tab of the 'ICPDAS DIO-48 Digital I/O Card Properties' dialog. It shows a list of resources with 'I/O Range' set to 02C0 - 02C3 and 'IRQ' set to 09. A callout box labeled '1. Select Input/Output Range' points to the 'I/O Range' entry. A 'Change Setting...' button is visible. The second screenshot is the 'Edit Input/Output Range' dialog, showing the 'Value' set to 02A0 - 02AF. A callout box labeled '2. Click "Change Setting" to change I/O Range (Depend on I/O Base Address)' points to the 'Change Setting...' button in the first screenshot. The dialog shows 'Conflict information' as 'No devices are conflicting'. The third screenshot is the 'Edit Interrupt Request' dialog, showing the 'Value' set to 09. A callout box labeled '3. Select Interrupt Request' points to the 'IRQ' entry in the first screenshot. Another callout box labeled '4. Click "Change Setting" to change Interrupt Request. (Depend on Interrupt Level setting)' points to the 'Change Setting...' button in the second screenshot. This dialog also shows 'Conflict information' as 'No devices are conflicting'.

9. Reboot the PC

The detail “add hardware” information. Please refer to

CD:\NAPDOS\ISA\Manual\PCI_ISA_PnP_Driver_Installation_in_Win9x_2K_XP.pdf

http://ftp.icpdas.com/pub/cd/iocard/isa/napdos/isa/manual/pci_isa_pnp_driver_installation_in_win9x_2k_xp.pdf

6

Pin Assignments

- CH1 and CH2 pin assignment.

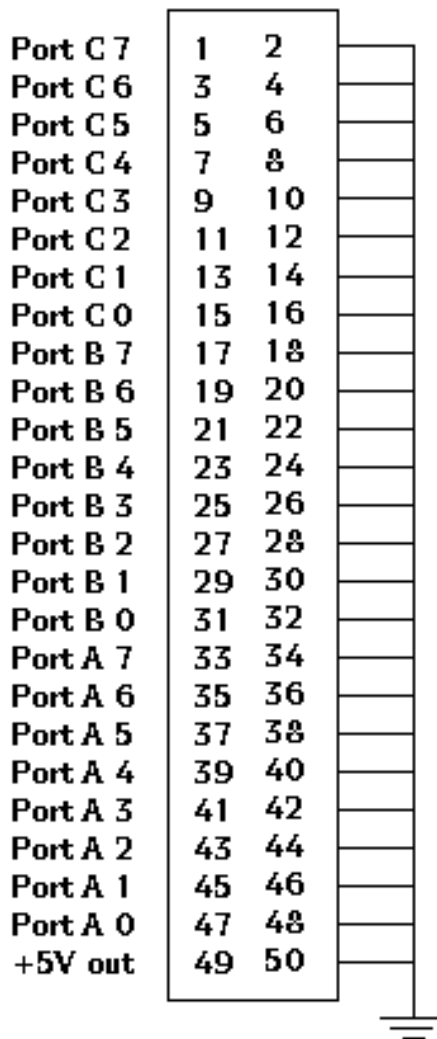

TTL Range	
High(1)	2.4 V ~5.0 V (Voltages over 5.0 V will damage the device)
None Defined	2.4 V~0.8 V
Low(0)	Under 0.8 V

7

Self Test

1. Use the CA-5002(Optional) to connect CN1 to CN2.

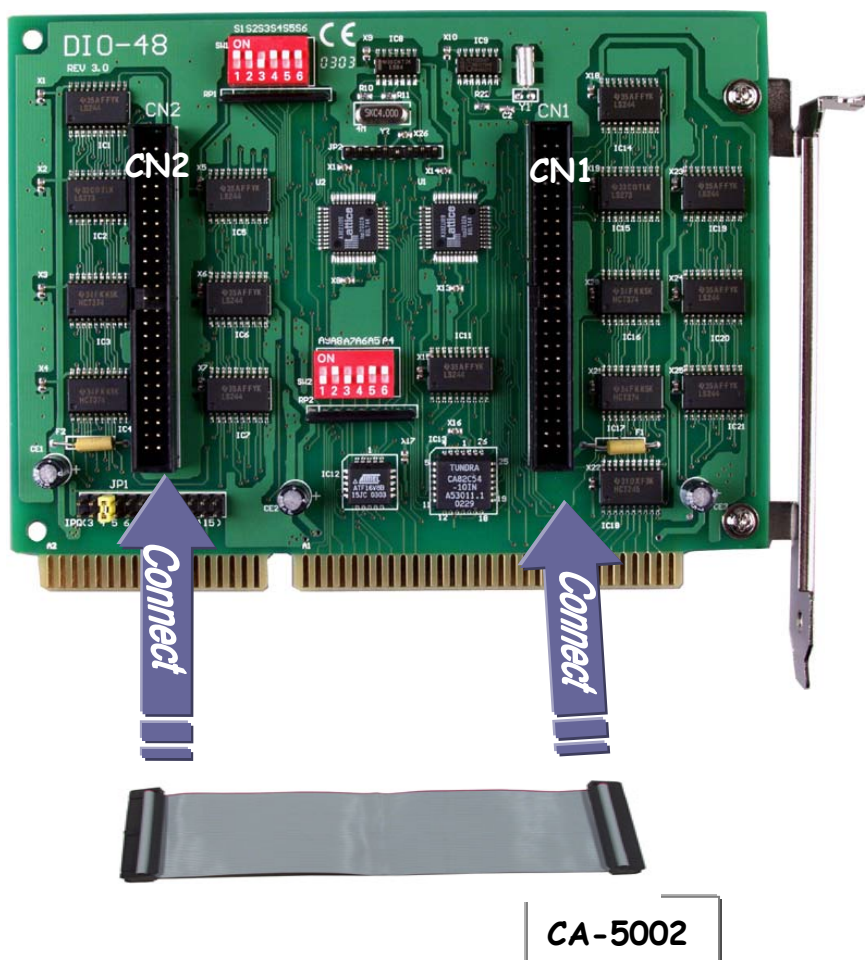

2. Execute the DIO-48 sample program.
Get the file from (Default path):
C:\DAQPro\DIO_WinXXX\Demo\

3. Get DIO function test result.

```
C:\DAQPro\DIO_WIN2K\Demo\VC6\D48Dio\Release\DIO48IO.EXE
Driver Initialize OK!!
Total Boards : 2
Please connect the CN1 with CN2 before testing...
The Base-Address of I/O port is: 0x2c0
Press <Enter> key to test the interrupt,
or press <Ctrl> + <c> key to exit program.
Setting CN1, CN2 to output-mode, Input-mode
Output CN1 Port A, B, C : 0x1, 0x1, 0x1
Input  CN2 Port A, B, C : 0x1, 0x1, 0x1
Output CN1 Port A, B, C : 0x2, 0x2, 0x2
Input  CN2 Port A, B, C : 0x2, 0x2, 0x2
Output CN1 Port A, B, C : 0x4, 0x4, 0x4
Input  CN2 Port A, B, C : 0x4, 0x4, 0x4
Output CN1 Port A, B, C : 0x8, 0x8, 0x8
Input  CN2 Port A, B, C : 0x8, 0x8, 0x8
Output CN1 Port A, B, C : 0x10, 0x10, 0x10
Input  CN2 Port A, B, C : 0x10, 0x10, 0x10
Output CN1 Port A, B, C : 0x20, 0x20, 0x20
Input  CN2 Port A, B, C : 0x20, 0x20, 0x20
Output CN1 Port A, B, C : 0x40, 0x40, 0x40
Input  CN2 Port A, B, C : 0x40, 0x40, 0x40
Output CN1 Port A, B, C : 0x80, 0x80, 0x80
Input  CN2 Port A, B, C : 0x80, 0x80, 0x80
Driver Close
Press <Enter> key to exit.
```

Check output value and input value is identical. It's test successfully.



8

Additional Information

✓ **DIO-48 Series Card Product page:**

http://www.icpdas.com/products/DAQ/pc_based/dio_48.htm

✓ **CA-5002(Optional) page:**

http://www.icpdas.com/products/Accessories/cable/cable_selection.htm

✓ **Documentation:**

CD:\NAPDOS\ISA\DIO>manual

<http://ftp.icpdas.com/pub/cd/iocard/isa/napdos/isa/dio/manual/>

✓ **Software:**

CD:\NAPDOS\ISA\DIO

<http://www.icpdas.com/download/isa/dio/index.htm>

The ICP DAS Web Site

<http://www.icpdas.com>



- Technical support
- Supplies and ordering information
- Methods of enhancing your device
- FAQ
- Application examples

Contact Us

Service@icpdas.com

Copyright ©2009 by ICP DAS Co., Ltd. All rights are reserved