

DN-8468UB Data Sheet

(Version 1.0)

Universal Snap-On Wiring Terminal Board

for PISO-PS400/I-8094 Series



ICP DAS CO., LTD.

泓格科技股份有限公司

DN-8468UB Wiring Terminal Board

The DN-8468UB is a universal snap-on wiring terminal board designed to connect between PISO-PS400 or I-8094 series motion controllers and various type of servo driver. Moreover, it also includes 4-axis I/O signals. Different servo drivers and stepper drivers can be easily connected with the motion controller which help to improve the competitiveness of our customer. This manual mainly describes the signal definitions and the operating instructions of the DN-8468UB. The content is divided into 4 parts: Board layout, I/O Signal connectors, Jumper and switch setting and LED function description.

1. Board Layout of DN-8468UB

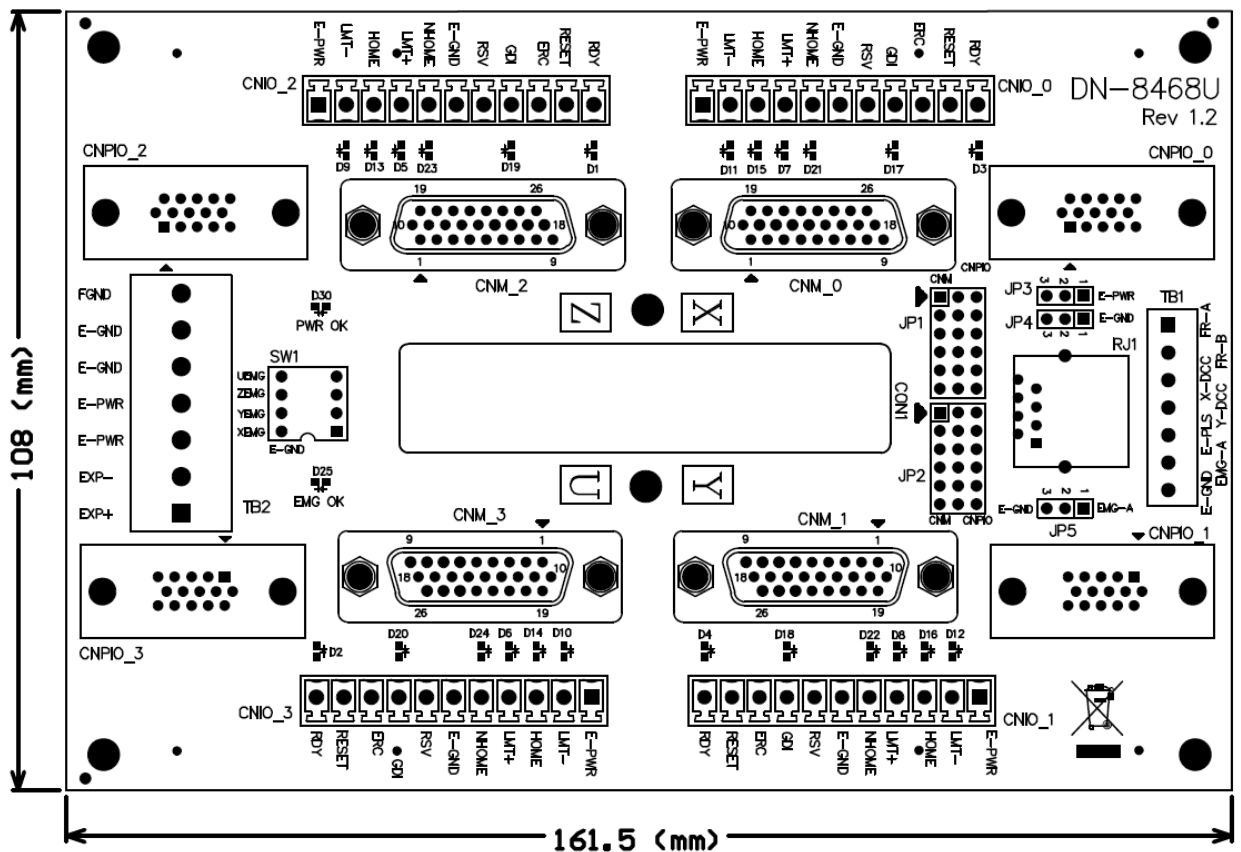

Fig. 1-1: Board layout of the DN-8468UB

2. Signal Connections of DN-8468UB

n Pin Assignment for CON1

The main I/O connector on the DN-8468UB is a 68-pin SCSI II connector which is used to connect with the motion card. Fig. 2-1 shows the pin assignment of the 68-pin I/O connector on the DN-8468UB, please refer to Table 2-1 and 2-2 for detailed descriptions of each I/O signal. However, the daughter board is connected directly with signals of the motion card, so the user can neglect this explanation.

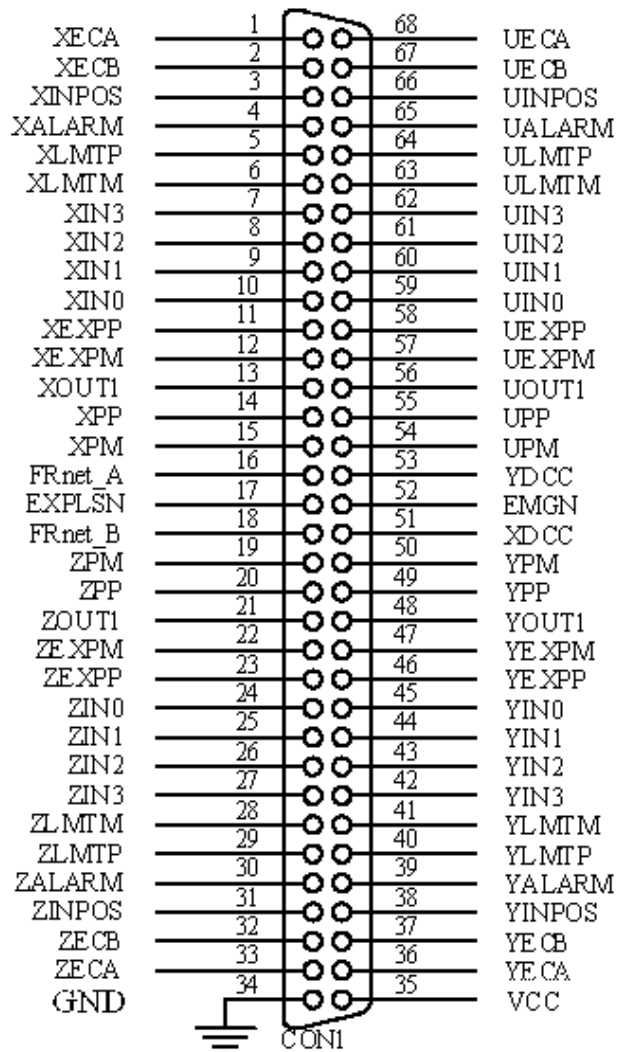

Fig. 2-1: Pin assignment of CON1

Table 2-1: Signal description of CON1 (part 1)

Pin name	Pin number	Description
XECA	1	Encoder A-phase signal for X axis
YECA	36	Encoder A-phase signal for Y axis
ZECA	33	Encoder A-phase signal for Z axis
UECA	68	Encoder A-phase signal for U axis
XECB	2	Encoder B-Phase signal for X axis
YECB	37	Encoder B-Phase signal for Y axis
ZECB	32	Encoder B-Phase signal for Z axis
UECB	67	Encoder B-Phase signal for U axis
XINPOS	3	In-position signal for X axis
YINPOS	38	In-position signal for Y axis
ZINPOS	31	In-position signal for Z axis
UINPOS	66	In-position signal for U axis
XALARM	4	Alarm signal for X axis
YALARM	39	Alarm signal for Y axis
ZALARM	30	Alarm signal for Z axis
UALARM	65	Alarm signal for U axis
XLMTM	5	Limit switch input signal (+) for X axis
YLMTM	40	Limit switch input signal (+) for Y axis
ZLMTM	29	Limit switch input signal (+) for Z axis
ULMTM	64	Limit switch input signal (+) for U axis
XLMTM	6	Limit switch input signal (-) for X axis
YLMTM	41	Limit switch input signal (-) for Y axis
ZLMTM	28	Limit switch input signal (-) for Z axis
ULMTM	63	Limit switch input signal (-) for U axis
XIN3	7	Input 3 signal for X axis
YIN3	42	Input 3 signal for Y axis
ZIN3	27	Input 3 signal for Z axis
UIN3	62	Input 3 signal for U axis
XIN2	8	Input 2 signal for X axis
XIN2	43	Input 2 signal for Y axis
XIN2	26	Input 2 signal for Z axis
XIN2	61	Input 2 signal for U axis
XIN1	9	Input 1 signal for X axis
YIN1	44	Input 1 signal for Y axis
ZIN1	25	Input 1 signal for Z axis
UIN1	60	Input 1 signal for U axis
XIN0	10	Input 0 signal for X axis
YIN0	45	Input 0 signal for Y axis
ZIN0	24	Input 0 signal for Z axis
UIN0	59	Input 0 signal for U axis

Table 2-2: Signal description of CON1 (part 2)

Pin name	Pin number	Description
XEXPP	11	EXT pulsar input signal (+) for X axis
YEXPP	46	EXT pulsar input signal (+) for Y axis
ZEXPP	23	EXT pulsar input signal (+) for Z axis
UEXPP	58	EXT pulsar input signal (+) for U axis
XEXPM	12	EXT pulsar input signal (-) for X axis
YEXPM	47	EXT pulsar input signal (-) for Y axis
ZEXPM	22	EXT pulsar input signal (-) for Z axis
UEXPM	57	EXT pulsar input signal (-) for U axis
XDRIVE	13	Driver enable signal for X axis
YDRIVE	48	Driver enable signal for Y axis
ZDRIVE	21	Driver enable signal for Z axis
UDRIVE	56	Driver enable signal for U axis
XPP	14	Driving pulsar signal (+) for X axis
YPP	49	Driving pulsar signal (+) for Y axis
ZPP	20	Driving pulsar signal (+) for Z axis
UPP	55	Driving pulsar signal (+) for U axis
XPM	15	Driving pulsar signal (+) for X axis
YPM	50	Driving pulsar signal (+) for Y axis
ZPM	19	Driving pulsar signal (+) for Z axis
UPM	54	Driving pulsar signal (+) for U axis
XOUT1	16	Output 1 signal for X axis
YOUT1	48	Output 1 signal for Y axis
ZOUT1	21	Output 1 signal for Z axis
UOUT1	56	Output 1 signal for U axis
EXPLSN1	17	EXT pulse input signal for interpolation
EMGN1	52	Emergency stop input signal
FRnetA	16	FRnet port A
FRnetB	18	FRnet port B
XDCC	51	Deviation Counter Clear for X axis
YDCC	53	Deviation Counter Clear for Y axis
GND	34	Internal Power Ground
VCC	35	Internal Power (5V)

n TB1 (7-pin removeable terminal block)

The connector TB1 enables you to connect some miscellaneous signals of the motion card. Table below shows the pin assignment and signal description of this connector.

No	Name	I/O	Note
1	E-GND	PWR GND	External power ground, directly connected to Pin#2 and Pin#3 of TB2
2	EMG-A	In	External emergency stop input (normally
3	E-PLS	In	External pulse input (not used yet)
4	Y-DCC	Out	Compare Output of Y axis
5	X-DCC	Out	Compare Output of X axis
6	FR_B	I/O	FRnet communication signal B (Negative end of differential FRnet communication signal)
7	FR_A	I/O	FRnet communication signal A (Positive end of differential FRnet communication signal)

n TB2 (7-pin terminal block)

The connector TB2 is used to power up the DN-8468UB, the external manual pulse generator can also be connected to the motion card via this connector. Table below shows the pin assignment and signal description of this connector.

No	Name	I/O	Note
1	FGND	Earth GND	Frame ground
2	E-GND	PWR GND	External power ground
3	E-GND	PWR GND	External power ground
4	E-PWR	PWR In	External power Input, +24V is recommended
5	E-PWR	PWR In	External power Input, +24V is recommended
6	EXP-	In	Negative direction input of external manual pulse generator
7	EXP+	In	Positive direction input of external manual pulse generator

n CNM_0 ~ CNM_3 (HD D-Sub 26 pin Female connector)

These connectors contain the commonly used control signals and I/O signals to the servo driver. ICP DAS provide various cables for easily snap-on connection between different servo drivers and the DN-8468UB.

No	Name	I/O	No	Name	I/O	No	Name	I/O
1	SRV_ON	Out	10	RESET	Out	19	EMG	Out
2	INP	In	11	ALARM	In	20	RSV	Out
3	ERC	Out	12	E-PWR	PWR	21	E-GND	Out
4	RDY	In	13	E-GND	PWR	22	E-GND	Out
5	P-	Out	14	N.C.	N.C.	23	N-	Out
6	P+	Out	15	N.C.	N.C.	24	N+	Out
7	A-	In	16	B-	In	25	Z-	In
8	A+	In	17	B+	In	26	Z+	In
9	N.C.	N.C.	18	N.C.	N.C.			

Note: Do not use signals marked as "N.C."

Table below shows the internal I/O connection when using different cable to connect with respective servo driver:

CNM_0~3			Mitsubishi MELSERVO-J3/J4		Yaskawa Sigma-II/III/V	
			CA26-MJ3-xx 50pin		CA26-YSV-xx 50pin	
Pin No.	Signal Name	Connected to	Pin No.	Signal Name	Pin No.	Signal Name
11	ALARM	Motion Card	48	ALM	31	ALM+
2	INPOS	Motion Card	24	INP	25	/COIN+
4	RDY	CNIO0~3	49	RD	29	/S-RDY+
10	RESET	CNIO0~3	19	RES	44	/ALMRST
3	ERC	CNIO0~3	41	CR / SP1	14	/CLR
20	RSV	CNIO0~3	17	PC / ST1	41	/P-CON
1	SRV_ON	Motion Card	15	SON	40	/S-ON
21	E-GND	EGND	43	LSP	42	P-OT
22	E-GND	EGND	44	LSN	43	N-OT
19	EMG	EMG-A or SW1	42	EMG	x	N.C.
12	E-PWR	TB2	20	DICOM	47	+ 24VIN
13	E-GND	TB2	47	DOCOM	26	/COIN-
13	E-GND		--	--	30	/S-RDY-
13	E-GND		--	--	32	ALM-
Note			--		To use the CLR (clear) function, SG signal on the servo driver should be connected to E-GND externally.	

CNM_0~3			Panasonic MINAS A4/A5		Fuji FALDIC-W, ALPHA5 Smart	
			CA26-PA4-xx 50pin		CA26-FFW-xx 26pin	
Pin No.	Signal Name	Connected to	Pin No.	Pin Name	Pin No.	Pin Name
11	ALARM	Motion Card	37	ALM+	17	OUT3 (ALMb)
2	INPOS	Motion Card	39	COIN+ / AT-SPEED+	16	OUT2 (PSET)
4	RDY	CNIO0~3	35	S-RDY+	15	OUT1 (RDY)
10	RESET	CNIO0~3	31	A-CLR	3	CONT2 (RST)
3	ERC	CNIO0~3	30	CL	5	CONT4 (CR)*
20	RSV	CNIO0~3	32	C-MODE	6	CONT5*
1	SRV_ON	Motion Card	29	SRV-ON	2	CONT1 (RUN)
21	E-GND	EGND	9	CCWL	x	N.C.
22	E-GND	EGND	8	CWL	x	N.C.
19	EMG	EMG-A or SW1	33	INH	4	CONT3 (EMG)*
12	E-PWR	TB2	7	COM+	1	P24
12	E-PWR		--	--	--	--
13	E-GND	TB2	38	COIN- / AT-SPEED-	14	M24
13	E-GND		34	S-RDY-	--	--
13	E-GND		36	ALM-	--	--
13	E-GND		41	COM-	--	--
Note			<p>For A4 servo driver, PrNo.40 should be set to "1" (the default value is "0")</p> <p>For A5 servo driver, Pr0.05 should be set to "1" (the default value is "0")</p>		<p>Please refer to the user's manual of servo driver to modify the setting below</p> <p>a. Set CONT4 as "7" (deviation clear)</p> <p>b. Set CONT3 as "5" (EMG)</p>	

CNM_0~3			Delta ASDA-A2		Delta ASDA-B2	
			CA26-DAA2-xx 50pin		CA26-DAB2-xx 44pin	
Pin No.	Signal Name	Connected to	Pin No.	Pin Name	Pin No.	Pin Name
11	ALARM	Motion Card	28	DO5+ (ALRM)	28	DO5+ (Alarm)
2	INPOS	Motion Card	1	DO4+ (TPOS) / (BRKR)	1	DO4+ (TPOS) / (BRKR)
4	RDY	CNIO0~3	7	DO1+ (SRDY)	7	DO1+ (SRDY)
10	RESET	CNIO0~3	33	DI5- (ARST)	33	DI5- (ARST)
3	ERC	CNIO0~3	10	DI2- (CCLR) / (TRQLM)	10	DI2- (CCLR) / (TRQLM)
20	RSV	CNIO0~3	34	DI3- (TCM0) / (SPD0)	34	DI3- (TCM0) / (SPD0)
1	SRV_ON	Motion Card	9	DI1- (SON)	9	DI1- (SON)
21	E-GND	EGND	31	DI7- (CCWL)	31	DI7- (CCWL)
22	E-GND	EGND	32	DI6- (CWL)	32	DI6- (CWL)
19	EMG	EMG-A or SW1	30	DI8- (EMGS)	30	DI8- (EMGS)
12	E-PWR	TB2	11	COM+	11	COM+
12	E-PWR		--	--	--	--
13	E-GND	TB2	6	DO1-	6	DO1-
13	E-GND		26	DO4-	14	COM-
13	E-GND		27	DO5-	26	DO4-
13	E-GND		49	COM-	27	DO5-
Note			Digit D of P1-00 (source of pulse command) must be set as "1" (line driver)		Digit D of P1-00 (source of pulse command) must be set as "1" (line driver)	

n CNIO_0 ~ CNIO_3 (11 pin removeable terminal block)

These connectors contain the input signal of mechanical switch (LMT+/-, NHOME, HOME) and some extra I/O interface to the servo driver (RDY, RESET, ERC, RSV). Table below shows the detailed description of these signal.

No	Name	I/O	Note
1	RDY	Out	Directly connect to pin#4 of CNM only (this signal is not feasible by the motion module). It is used to obtain the READY status of servo driver.
2	RESET	In	Directly connect to pin#10 of CNM only (this signal is not feasible by the motion module). It is used to reset the alarm status of servo driver.
3	ERC	In	Directly connect to pin#3 of CNM only (this signal is not feasible by the motion module). It is used to clear the error counter (or deviation counter) of servo driver.
4	GDI	In	General purpose DI. The status of this signal can be obtained by calling function <code>xxxxx_get_in3()</code> .
5	RSV	In	Directly connect to pin#20 of CNM only (this signal is not feasible by the motion module). The definition of this signal depended on the servo driver. Please refer to the I/O connection table of CNM for detail.
6	E-GND	GND	External power ground, directly connected to Pin#2 and Pin#3 of TB2
7	NHOME	In	Near Home signal for automatic home search
8	LMT+	In	End limit signal in Positive direction
9	HOME	In	Home signal for automatic home search
10	LMT-	In	End limit signal in Negative direction
11	E-PWR	PWR	Positive end of External power, directly connected to Pin#4 and Pin#5 of TB2

n CNPIO_0 ~ CNPIO_3 (HD D-Sub 15 pin female connector)

In addition to CNM_0~CNM_3, these connectors are designed to enable users to connect the motion module to external stepping driver or linear scale. Table below shows the pin assignment for the 15-pin connector on the DN-8468UB.

No	Name	I/O	No	Name	I/O	No	Name	I/O
1	P+	Out	6	E5V	PWR	11	Z+	In
2	N+	Out	7	P-	Out	12	Z-	In
3	E-GND	GND	8	N-	Out	13	SRV_ON	Out
4	A-	In	9	A+	In	14	ALARM	In
5	B-	In	10	B+	In	15	E-PWR	PWR

Note : The E5V is a 5-Volt power output which derived from E-PWR in DN-8468UB.

Please do not use more then 200mA in one DN-8468UB.

n RJ1 (RJ45 connector)

The connectors RJ1 is an 8-pin RJ45 connector that enable you to connect to the signals of FRnet. Table below shows the pin assignment of this connector.

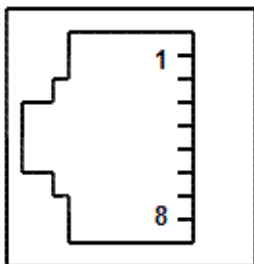

No	Name	I/O	Note
1	E-GND or N.C.	PWR GND	These signals can be set by JP4.
2	E-GND or N.C.	PWR GND	
3	FR_A	I/O	Positive end of differential FRnet communication signal, directly connected to Pin#7 of TB1
4	N.C.	-	-
5	N.C.	-	-
6	FR_B	I/O	Negative end of differential FRnet communication signal, directly connected to Pin#6 of TB1
7	E-PWR or N.C.	PWR	These signals can be set by JP3.
8	E-PWR or N.C.	PWR	

3 Jumper and Switch Settings

n JP1 ~ JP2

The encoder signals of axis X and axis Y can be chosen from the encoder of servo driver (CNM) or from the external linear scale (CNPIO). Fig. 3-1 shows that the encoder signals are selected from the encoder servo driver (CNM). Fig. 3-2 shows that the encoder signals are selected from external linear scale (CNPIO).

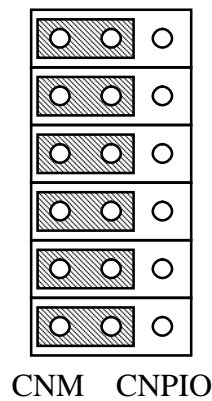

Fig. 3-1: The Encoder signals of motion module are from CNM (default setting)

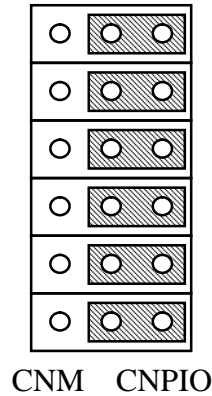

Fig. 3-2: The Encoder signals of motion module are from CNPIO

n JP3 ~ JP4

These jumpers are used to select whether to connect the external power to the RJ-45 connector of FRnet (RJ1). Please refer to Chapter 2 for the signal definition of RJ1.

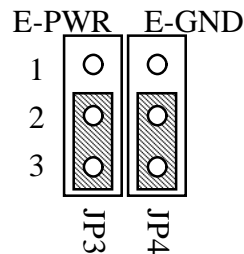

Fig. 3-7: Do not connect external power to RJ1 (default setting)

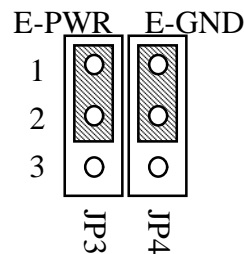

Fig. 3-8: Connect external power to RJ1

n JP5

This jumper is used to set whether to use the external emergency stop switch on Pin#2 of TB1 (EMG-A) to control the EMG signal of motion module (CON1 pin#52). For designe which do not equipped with the external emergency stop switch, the EMG signal of motion module can be directly connected to E-GND by setting this jumper.

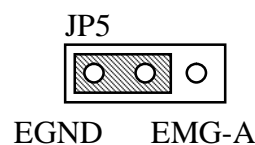

Fig. 3-3 The EMG signal of motion module is connect to E-GND (default setting)

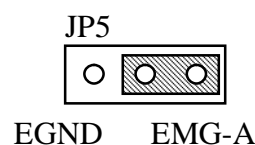

Fig. 3-4 The EMG signal of motion module is controlled by Pin#2 of TB1 (EMG-A)

n SW1

This switch is used to set whether to use the external emergency stop switch on Pin#2 of TB1 (EMG-A) to control the EMG signal of all servo drivers (CNM pin#19). For designe which do not equipped with the external emergency stop switch, the EMG signal of servo drivers can be directly connected to E-GND by setting this switch.

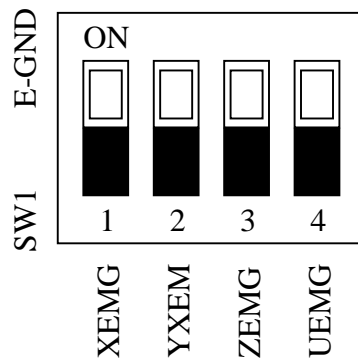

Fig. 3-5: The EMG signals of servo drivers are connect to E-GND (default setting)

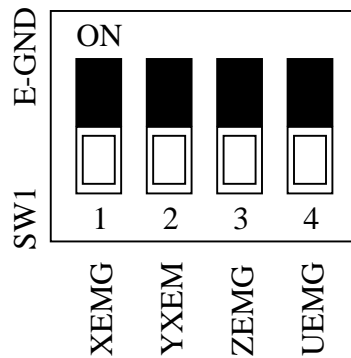

Fig. 3-6: The EMG signals of servo drivers are controlled by Pin#2 of TB1 (EMG-A)

4 LED Description

LEDs are used to indicating the status of important inputs. The definitions and meanings of all LEDs are shown as followed:

- I **LMT – (Red)**: It shows the minus end-limit signal of motion control on the machine. The minus end-limit signal of motion axis is to decide the end point of minus moving. If this signal is on, the LED will be turned on. (This is the case when "Normal Open" mode is set, for "Normal Close" mode, the LED is turned off when signal is on.)
- I **HOME (Yellow)**: It shows the original signal of motion control on the machine. The LED will be turned on when the motion control is moved to the original signal.
- I **LMT + (Red)**: It shows the plus end-limit signal of motion control on the machine. The plus end-limit signal of motion axis is to decide the end point of plus moving. If this signal is on, the LED will be turned on. (This is the case when "Normal Open" mode is set, for "Normal Close" mode, the LED is turned off when signal is on.)
- I **NHOME (Yellow)**: It shows the near original signal of motion control on the machine. The LED will be turned on when the motion control is moved to the near original signal.
- I **GDI (Green)**: It shows the status of GDI signal on CNIO Pin#4. The LED will be turned on when the GDI signal on CNIO Pin#4 is connected to E-GND.
- I **RDY (Green)**: It point out whether the servo motor is in the state that can be controlled. The LED will be turned on when the motor can be controlled.
- I **Power (Red)**: It shows the power state of DN-8468UB. The LED will be turned on when the power is good.
- I **EMG (Green)**: It shows the state of EMG signal of motion module (CON1 pin#52). The motion module can driver the motors only when this LED is turned on.

5 Revision History

Rev 1.0 2012/12/13 initial version