iCAM-721F
3 MP IR Bullet Network
Camera

User's Manual

Version 2.0



ICP DAS CO., LTD.

泓格科技股份有限公司

Warranty

All products manufactured by ICP DAS are under warranty regarding defective materials for a period of one year, starting from the date of delivery to the original purchaser.

Warning

ICP DAS CO., LTD. assumes no liability for damages consequent to the use of this product. ICP DAS CO., LTD. reserves the right to change this manual at any time without notice. The information furnished by ICP DAS CO., LTD. is believed to be accurate and reliable. However, no responsibility is assumed by ICP DAS CO., LTD. for its use, or for any infringements of patents or other rights of third parties resulting from its use.

Copyright and Trademark Information

© Copyright 2017 by ICP DAS CO., LTD. All rights reserved worldwide.

Trademark of Other Companies

The names used for identification only maybe registered trademarks of their respective companies.

License

The user can use, modify and backup this software on a single machine. The user may not reproduce, transfer or distribute this software, or any copy, in whole or in part.

Technical Service:

Please contact local agent or email problem-report to service@icpdas.com .
For more product information, please refer to www.icpdas.com .

Technique: Cony Yu; Translation & Edition: Eva Li; R&D Dept., ICP DAS CO., LTD.
Latest edited by: Eva Li; V. 2.0, 08/2020

Contents

Contents	3
Revision History	5
Read Me First!	7
Important Notes	7
1 Introduction	7
1.1 Hardware Overview	9
1.2 Specifications.....	10
2 Installation and Setup	13
2.1 Install microSD Card	13
2.2 Connecting Camera to Network	14
2.3 Configuring Camera via CAM FINDER	15
2.3.1 Use CAM FINDER to Assign IP Address	17
2.3.2 Open the Web-based UI of the Camera	20
3 Live View UI Settings	23
3.1 Quick Access Buttons	25
3.2 Camera Live View UI Setting Tools	26
4 Setup	29
4.1 System Setup.....	30
4.1.1 Information Tab	31
4.1.2 Time Tab.....	32
4.1.3 Security Tab	34
4.1.4 Maintenance Tab.....	36
4.1.5 System Log Tab	38
4.2 Network Setup	39
4.2.1 General Tab.....	40
4.2.2 DDNS Tab	42
4.2.3 Multicast Tab	43
4.2.4 IP Filter Tab	45
4.2.5 WISE Tab	46
4.3 Video & Audio Setup.....	47
4.3.1 Stream Tab	48
4.3.2 Video Tab.....	51
4.3.3 Audio Tab	55
4.3.4 Privacy Mask Tab	56

4.3.5 ROI Tab	58
4.4 Event Setup	60
4.4.1 Motion Tab	61
4.4.2 Video Tab.....	63
4.4.3 Snapshot Tab	68
4.4.4 GPIO Tab.....	73
4.5 Local Storage Setup	74
4.5.1 Local Storage Tab	75
4.5.2 Playback Tab.....	76
5 Appendix	77
5.1 Firmware Upgrade and Trouble Shooting.....	77
5.2 How to let camera to do Hardware Reset	87

Revision History

Revision History Table

Doc. Version	Revision Description	Date
2.0	Modify List of Version 2.0: 1. The new website of ICP DAS is online in May 2020, so change the links in this manual to the new webpages. 2. ICP DAS Homepage: http://www.icpdas.com/ 3. iCAM Products Website: http://www.icpdas.com/en/product/guide+IIoT+IO_Sensor+IP_Camera	20200818
1.0	Initial Official Release: 1. For Chapter 1, features, hardware picture and specifications. 2. Add Section 2.2 about how to install microSD card into the camera. 3. Add Section 4.3.5 WISE Tab for communicating the camera with the WISE controller to perform a WISE Surveillance Solution. 4. For Chapter 3, modify the "Live View" button related descriptions. 5. For Chapter 1 to 5, modify its description for more detail and clear. 6. Add section 5.2 about the hardware reset.	2017/08/10

Read Me First!

Important Notes

This User Manual is intended for administrators and users of the iCAM-760D Dual Lens Panoramic Dome Network Camera, including instructions for using and managing the camera on your network. The use of surveillance devices may be prohibited by law in your country or area. It is therefore the user's responsibility to ensure that the operation of such devices is legal before installing this unit for its intended use.

Before the Dome Network Camera is installed, carefully read and follow all the safety and operating instructions to avoid damage due to faulty assembly and installation. This also ensures that the device is used properly as intended.

Heed All Warnings

- **Do not drop or hit the device.**
Sensitive electronics inside the camera are vulnerable to excessive impact.
- **Do not install the device under high temperature (less than 45°C) environment.**
Excessive heat could damage the equipment.
- **Do not cover device with any object or install it in a poorly ventilated vicinity.**
Overheating could damage the camera.
- **Do not expose the device to rain or moisture. Do not touch the power connection with wet hand.**
Risk of short circuit, electric shock, or fire
- **Do not damage the power cord or leave it under pressure.**
Risk of fire or circuit electric shock
- **To reduce the risk of electric shock or damage, do not remove the front or back cover.**
There is no user-serviceable parts inside. Misusage, improper, or negligent handling could damage the device. Refer to qualified service personnel from our distributor/dealer for any device related trouble shooting need.
- **Do not continue to operate the device if it appears to malfunction.**
Contact qualified service personnel from our distributor/dealer for help.
- **Installation of the product should be made by qualified service personnel or system installers from our distributor/dealer.**

1 Introduction

iCAM-721F is a professional bullet camera offering 1080p Full HD resolution with super image quality up to 30 fps. Featuring 3-Megapixel resolution and high-performance H.264/MPEG-4/MJPEG compression technology, the iCAM-721F offers extra-smooth video and wide coverage.

iCAM-721F employs many advanced features to allow users to fully utilize the high definition video. Focus on a region of interest (ROI) in the camera view to enhance image quality. It also saves the cost of network and backend storage without network bandwidth of video streaming.

Aimed at outdoor surveillance, **iCAM-721F** is furnished with a fixed-iris lens, a removable IR-cut filter, 15-meter IR illuminators, Wide Dynamic Range (WDR), and multi-functional environment profile image settings for superior image quality around the clock. Moreover, the IP67-rated housing protects against rain and dust and ensures functional operation in all types of weather conditions.

With other advanced features such as motion detection, 802.3af compliant PoE, ONVIF Compliant for interoperability, built-in microSD/microSDHC/microSDXC card slot for storage, two-way audio, and digital input/output for alarm, the iCAM-721F is an all-in-one bullet network camera for detailed surveillance in outdoor environments.



Features:

- 6 mm Fixed-Focal, Fixed-Iris Lens
- 3-Megapixel CMOS Sensor
- 30 fps@1080p Full HD
- Removable IR-cut Filter for Day & Night Function
- Built-in IR Illuminators, Effective up to 15 Meters
- Real-time H.264, MPEG-4, and MJPEG Compression
- ROI (Region of Interest) for Enhancement of Image Quality
- Low Lux for Night Vision
- WDR Enhancement for Visibility in Extremely Bright or Dark Environments
- Two-way Audio Communication

- Built-in microSD card slot, support microSDHC/microSDXC 64GB or above
- Weather-proof IP67-rated Housing
- Built-in 802.3af Compliant PoE
- ONVIF Compliant for interoperability



1.1 Hardware Overview

iCAM-721F



Dimensions

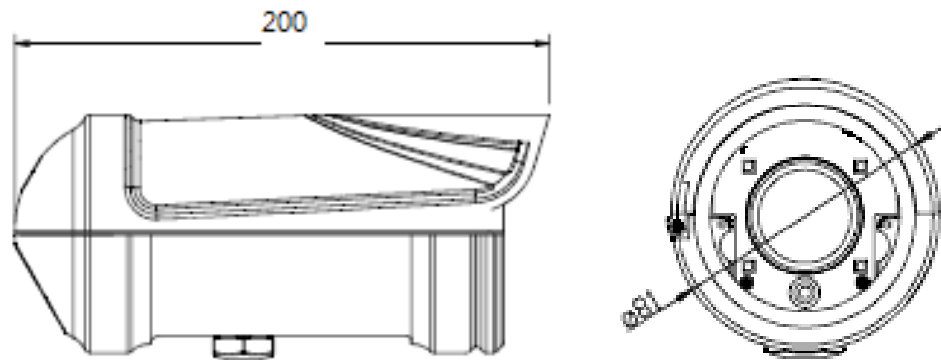

Cable Connections:

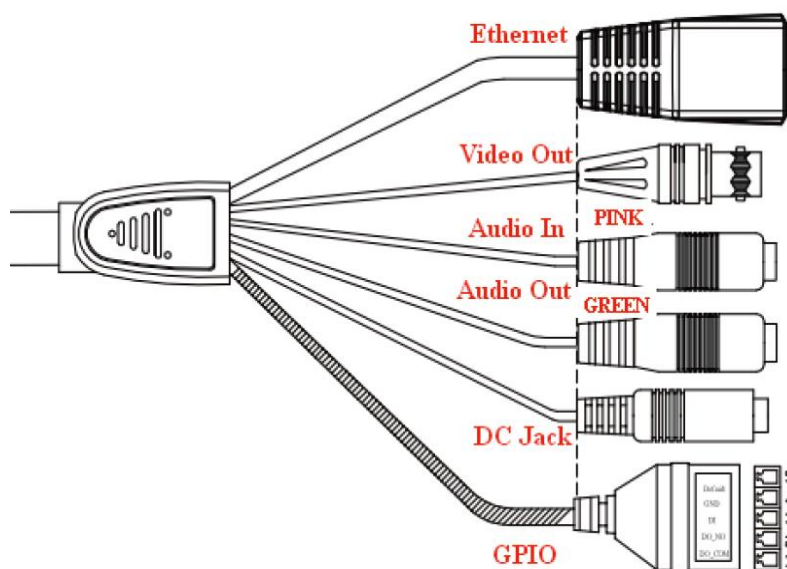

Pin Number	Pin Definition
1	DO_COM
2	DO_NO
3	DI
4	GND
5	Default Setting

1.2 Specifications

Model	iCAM-721F
System Information	
CPU	Multimedia SoC (System-on-Chip)
NOR Flash	16 MB
RAM	512 MB
Camera Features	
Image Sensor	1/3" Progressive CMOS sensor in 2048 x 1536 resolution
Maximum Resolution	2048x1536, 3 MP
Lens Type	Fixed-Focal (M12*0.5)
Focal Length	f = 6 mm
Aperture	F1.6 ,Fixed-Iris
Field of View	48.8°(H); 36.6°(V); 61°(D)
Shutter Time	1 sec. to 1/1,000,000 sec.
WDR Technology	WDR Enhanced
Day/Night	Removable IR-cut filter for day & night function
Minimum Illumination	1.5 Lux @F1.2 (Color); 0.001 Lux @F1.0 (B/W)
IR Illuminators	Built-in IR illuminators, effective up to 15 meters; High Power IR LED x 4
On-board Storage	Built-in microSD card slot, support microSDHC/microSDXC 64GB or above
Video	
Compression	H.264 / MJPEG / MPEG-4
Maximum Frame Rate	15 fps at 2048x1536 30 fps at 1920x1080 30 fps at 1600x1200, 1280x960, 1280x720, 800x600, 640x480, 720x405 30 fps at 720x405 (Mobile)
Maximum Streams	3 simultaneous streams
S/N Ratio	Above 39 dB
Dynamic Range	100 dB
Video Streaming	Adjustable resolution, quality and bitrate ROI (Region of Interest) for Enhancement of Image Quality
Image Settings	Adjustable image size, quality and bitrate Configurable brightness, saturation, exposure control,

Model	iCAM-721F
	sharpness, contrast, white balance, auto shutter control, auto gain control, noise reduction, EV luminance control, flip & mirror, privacy masks, time stamp, text overlay
Audio	
Audio Capability	Audio input/output (full duplex)
Compression	G.711u
Interface	External microphone input
Effective Range	5 meters
Network	
Users	Live viewing for up to 10 clients
Protocols	HTTP, HTTPS, TCP/IP, IPv4, UDP, SMTP, FTP, DHCP, DDNS, NTP, DNS, ARP, RTSP, RTP, UPnP, ONVIF(Profile S), Multicast
Protection	Multiple user access levels with password protection, IP address filtering
Interface	10 Base-T/100 BaseTX Ethernet(RJ-45)
ONVIF	Ver. 2.2
Intelligent Video	
Motion Detection	Ten-windows video motion detection
Alarm and Event	
Alarm Triggers	Video motion detection, manual trigger, digital input, periodical trigger, system boot, recording notification
Alarm Events	Event notification using digital output, HTTP, SMTP, FTP and NAS server File upload via HTTP, SMTP, FTP and NAS server
General	
Connectors	RJ-45 cable connector for Network/PoE connection Audio input Audio output Video output * 1 Digital input * 1 Digital output * 1
Power Input	IEEE 802.3af PoE DC 12V
Power Consumption	IR ON Max. 12W (PoE) IR OFF Max. 5W (PoE)
Dimensions	Ø:200 L x 81H x 81W mm



Model	iCAM-721F
Weight	Net: 350g
Casing	Weather-proof IP67-rated housing
Safety Certifications	CE, FCC Class B, LVD
Operating Temperature	Starting : -10°C ~ 50°C Working : -40°C ~ 50°C
Operating Humidity	10% ~ 80%
System Requirements	
Operating System	Microsoft Windows 10/8/Vista/XP
Web Browser	Mozilla Firefox 7 ~ 52, Internet Explorer 7 ~ 11
Other Players	VLC: 1.1.11 or above

2 Installation and Setup

2.1 Install microSD Card

The **iCAM-721F** built-in microSD card slot supports microSDHC/microSDXC 64 GB or above for local storage application.

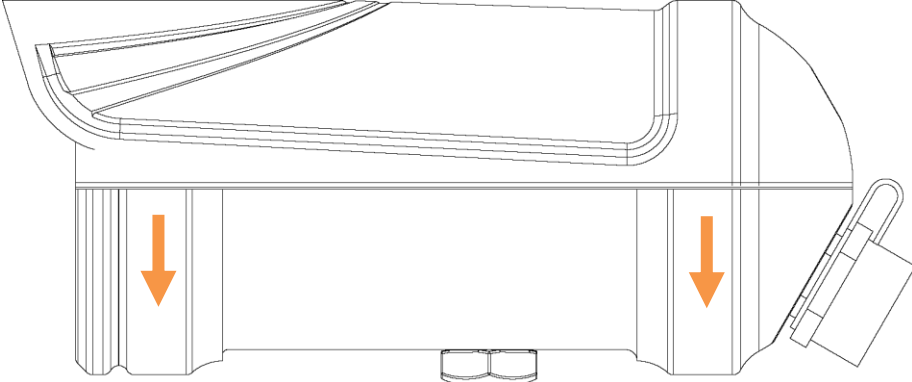
The user can prepare a microSD card to install into the camera via the following steps.

Step 1	Loose the 2 screws of the cover, and open the cover.
	
Step 2	Find the microSD card slot as the following picture. Insert the microSD card into the slot. Finally, put the cover back to the camera.
	

2.2 Connecting Camera to Network

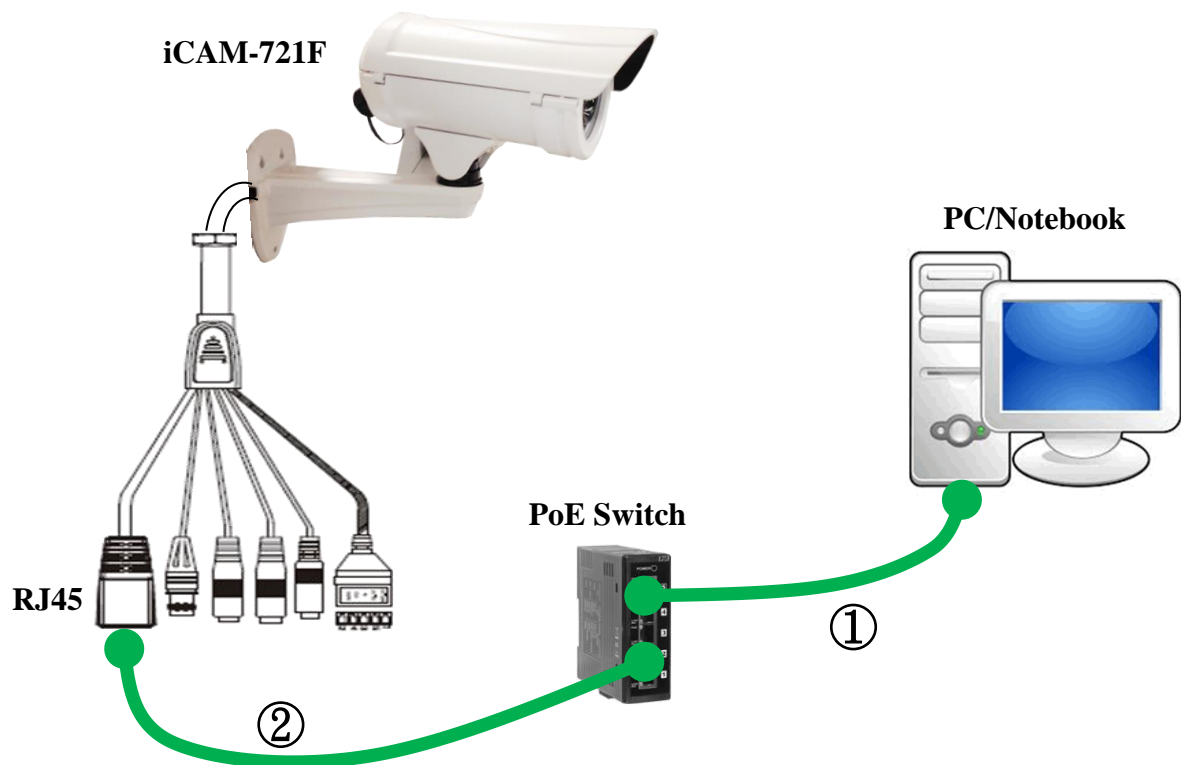

- 1) Be sure that your PC or laptop has connected to your local Ethernet network.
- 2) Be sure that IP Camera has connected to your local networking via the LAN port (RJ45) on the cable. For this PoE model, user can use PoE Switch as power supply.
- 3) Use CAM FINDER software utility in CD to set up the camera (see [2.3 Configuring Camera via CAM FINDER](#)), or directly set up the camera via the Microsoft IE browser using the following default IP information:

IP: 192.168.255.2 (Default Username/Password: admin/admin)
Submask: 255.255.0.0
Gateway address: 192.168.0.1
DNS Server address: 8.8.8.8

2.3 Configuring Camera via CAM FINDER

The user can configure iCAM by default IP address or via the software utility.

The default IP Address configuring: see [2.2 Connecting Camera to Network](#)

The software utility **CAM FINDER** is in the attached Software Package CD.

The **CAM FINDER** is used to find and configure network cameras on the LAN. This utility is useful for conveniently configuring the network settings of the device, or for finding a device once the network settings have been modified.

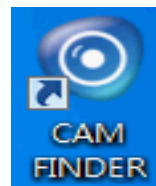

The **CAM FINDER** programs are located in the Software **iCAM CD** provided together with the device. Please insert the CD into the PC CD-ROM Drive, open the folder “**Software_Utility**” and then “**CAM FINDER**”. Launch the **CAM FINDER** setup file “**setup.exe**” and complete the installation step by step.

iCAM CD Path: \Software_Utility\Cam Finder\  setup.exe

The latest version of the **CAM FINDER** software program is available on the **iCAM** product website:

http://www.icpdas.com/en/product/guide+IIoT+IO_Sensor+IP_Camera

Or directly download from the following FTP path:

<http://www.icpdas.com/en/download/index.php?nation=US&kind1=&model=&kw=iCAM>

NOTE

1. In order to ensure **CAM FINDER** utility has the best compatibility with Camera, kindly please ask for distributor/dealer’s help to get the latest version downloading.
2. In order to ensure Camera will be assigned IP Address properly, please confirm the following things.
 - Always consult your network administrator in order to avoid using a previously assigned IP address.
 - Check if the Camera is powered on and correctly connected to the network.
 - In order to connect to the Web-based user interface of the camera, the host PC must be in the same subnet. For more information about subnets, please consult your network administrator.

Once CAM FINDER has been successfully installed on the PC/notebook, double click the CAM FINDER icon on the Desktop of PC or choose “**Start > All Programs > CAM FINDER**” path to run the software.



The **CAM FINDER** window is showing as the following picture.

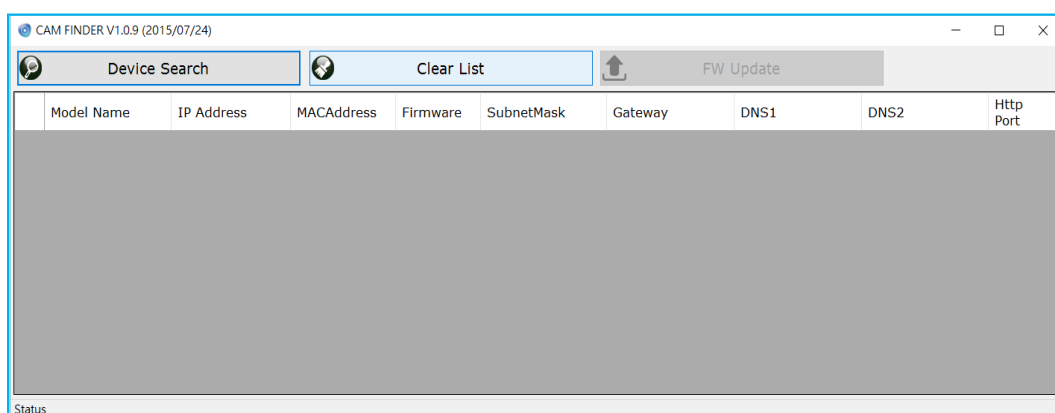

If want to change the **software language**, please click the right key of mouse on the gray area and select the [Language] to choose one language from the [Traditional Chinese], [English], [Spanish] and [Simplified Chinese].

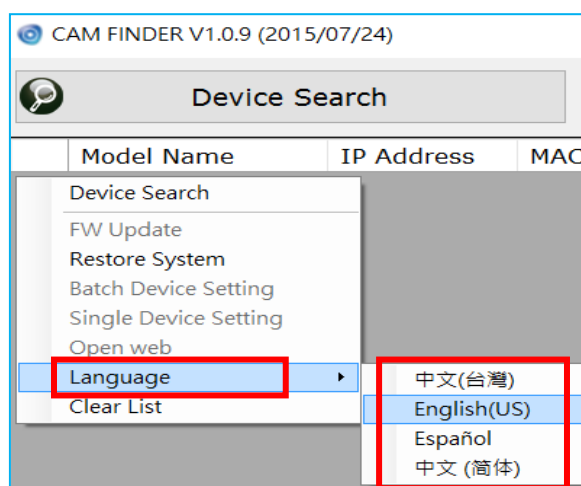

2.3.1 Use CAM FINDER to Assign IP Address

1. Click the [Device Search] to search the camera on the network.

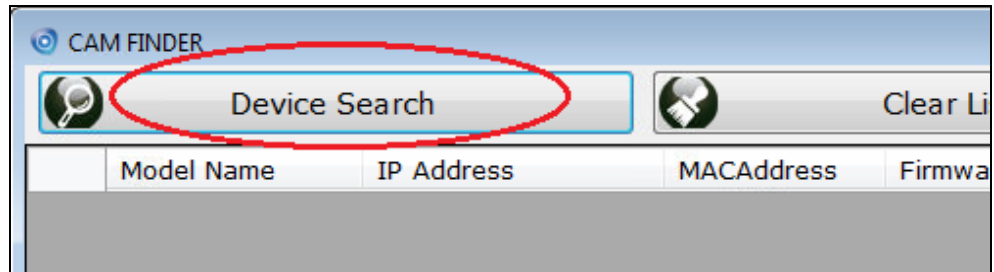

2. Under your selected item, double-click the left Mouse button or Right-click the Mouse button to open the Property Page of the [Single Device Setting].

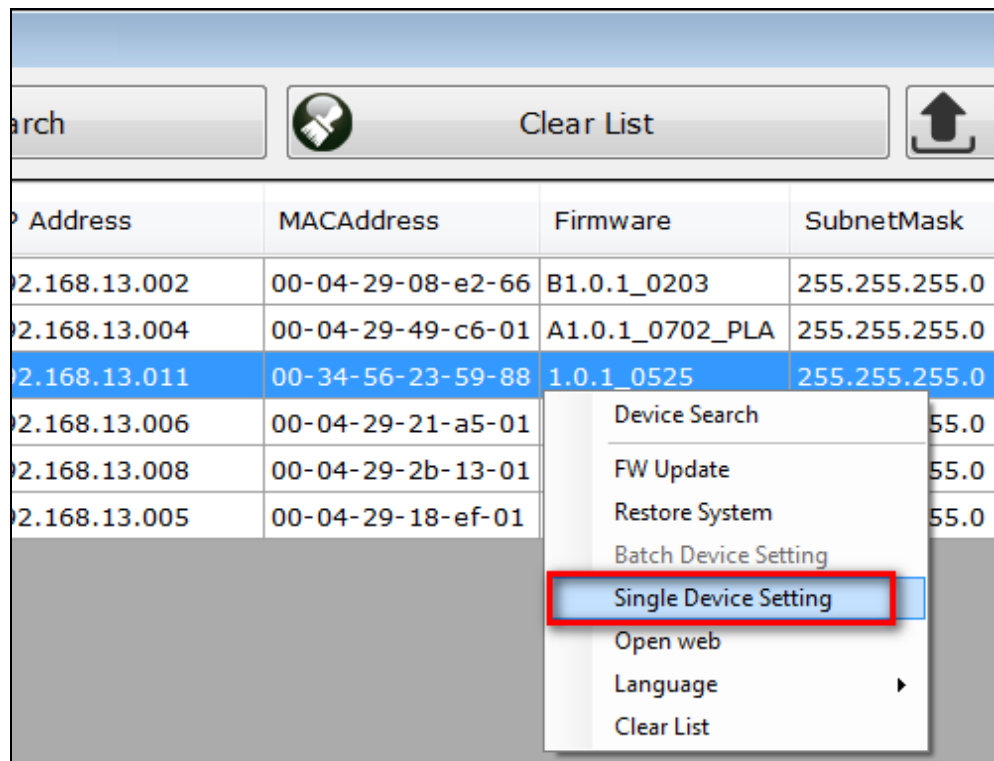

3. Check [**Static IP address**] item to select the network connection method of the camera.

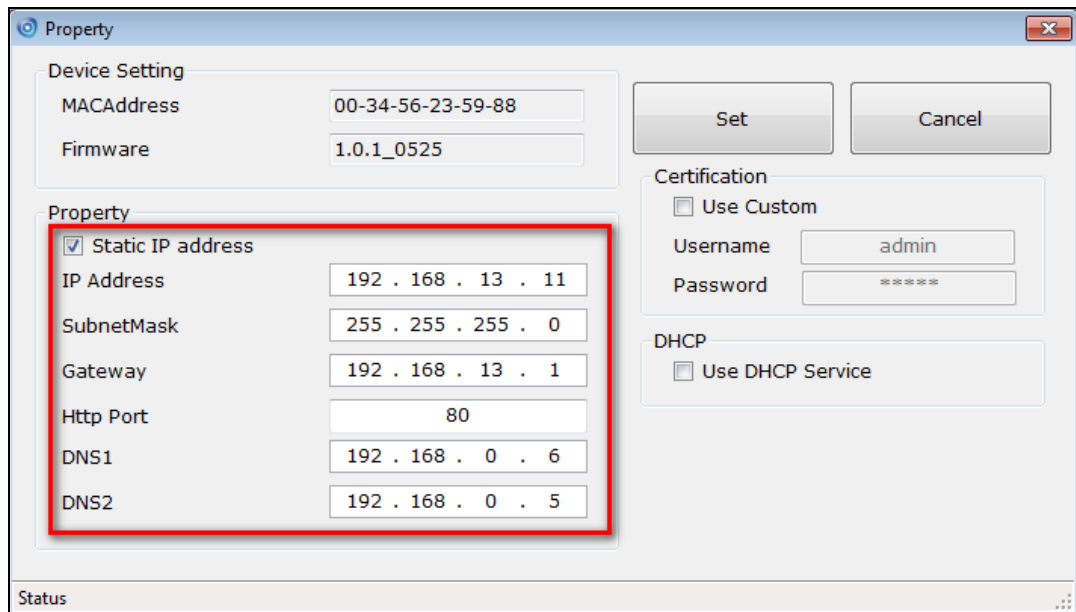

The screenshot shows a 'Property' dialog box with the following sections:

- Device Setting**:
 - MACAddress: 00-34-56-23-59-88
 - Firmware: 1.0.1_0525
- Property**:
 - Static IP address
 - IP Address: 192 . 168 . 13 . 11
 - SubnetMask: 255 . 255 . 255 . 0
 - Gateway: 192 . 168 . 13 . 1
 - Http Port: 80
 - DNS1: 192 . 168 . 0 . 6
 - DNS2: 192 . 168 . 0 . 5
- Certification**:
 - Use Custom
 - Username: admin
 - Password: *****
- DHCP**:
 - Use DHCP Service

Buttons: Set, Cancel

Status: [...]

4. After modifying the camera properties, click [**Set**] button to save and enable the configuration modifications.

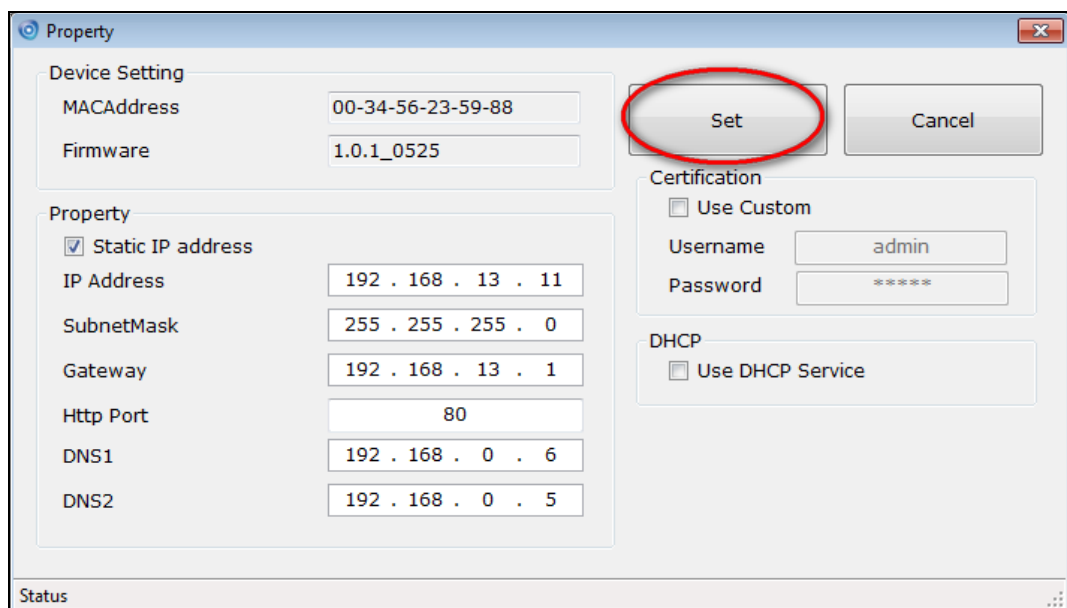

The screenshot shows the same 'Property' dialog box as above, but with the 'Set' button circled in red to indicate it should be clicked to save the changes.

5. This Utility can batch modify IP address automatically. Use “Ctrl” or “Shift” key on the keyboard to choose several Camera Devices. Then click the **[Batch Device Setting]** to configure them together.

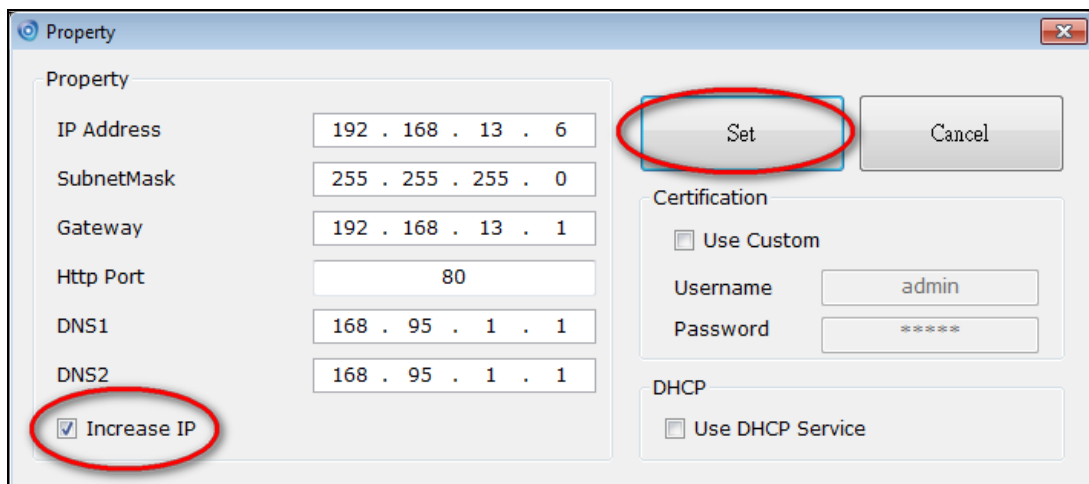
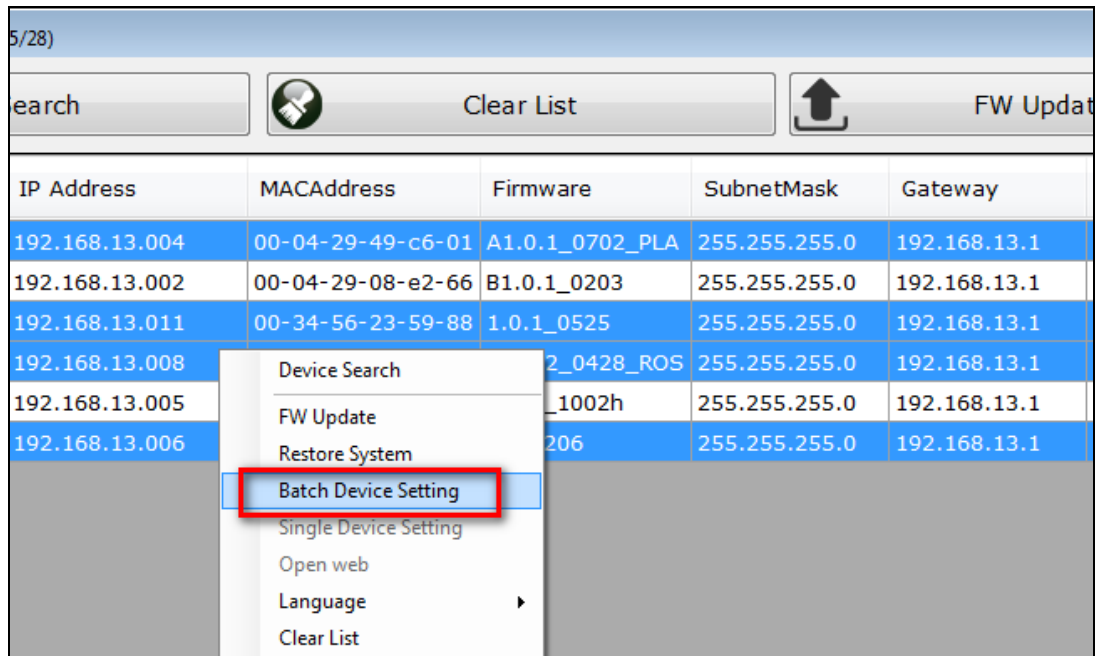

2.3.2 Open the Web-based UI of the Camera

- To access the Web-based UI of the selected unit, run the [Open Web] on the select item from the CAM Finder software window.

del Name	IP Address	MACAddress	Firmware	Subn
760D	192.168.13.004	00-04-29-49-c6-01	A1.0.1_0702_PLA	255.2
760D	192.168.13.002	00-04-29-08-e2-66	B1.0.1_0203	255.2
760D	192.168.13.011	00-34-56-23-59-88	1.0.1_0525	255.2
760D	192.168.13.008		2_0428_ROS	255.2
760D	192.168.13.005		2_1002h	255.2
760D	192.168.13.006		1206	255.2

Device Search
FW Update
Restore System
Batch Device Setting
Single Device Setting
Open web
Language
Clear List

- Manual input the username and password for the login authentication of camera webpage. For the first time login of setting or using, please use the default username admin, password admin.

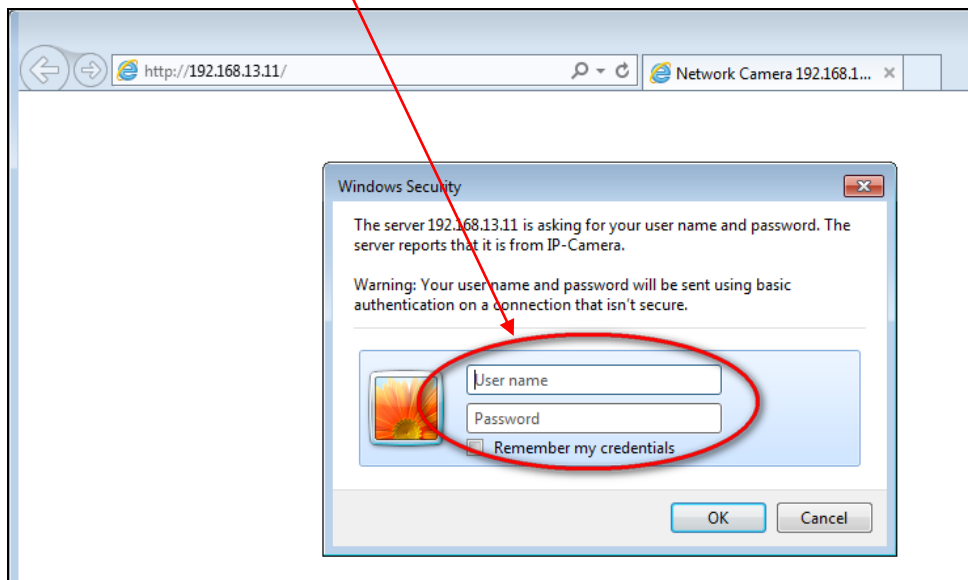

NOTE:
Use of Microsoft IE browser is recommended as it offers a better compatibility.

3. For first time user, there will be a prompt to install the **NetcamViewer** and allow the **ActiveX** control. Comply with the ActiveX installation as they are needed to view the video stream and some other operations.

Besides, use of Microsoft IE browser is recommended as it offers a better compatibility.

Please click the **NetcamViewer** hyper-link to download and install it.

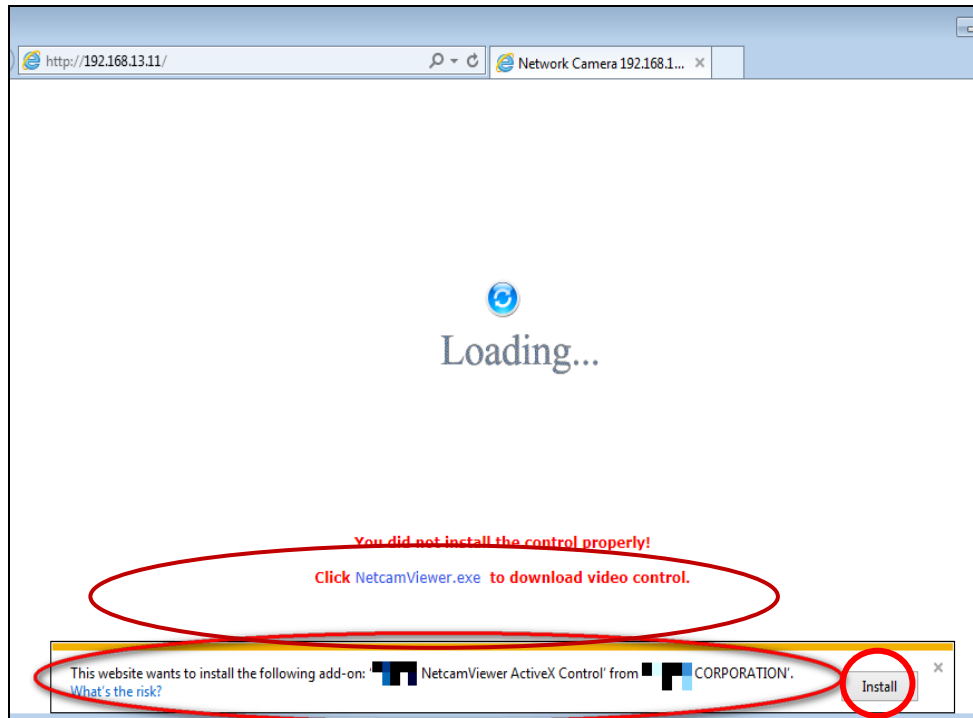

NOTE:

Please also note to close all browser applications before NetcamViewer web component installation.

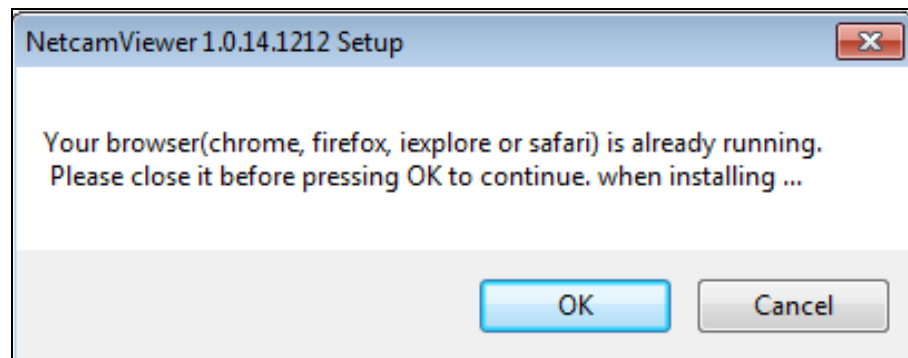

4. If the camera and browser components have been configured correctly, the default Web browser will open to the Live View page of the selected camera.

*** Username and password is required. (Default is admin / admin)**

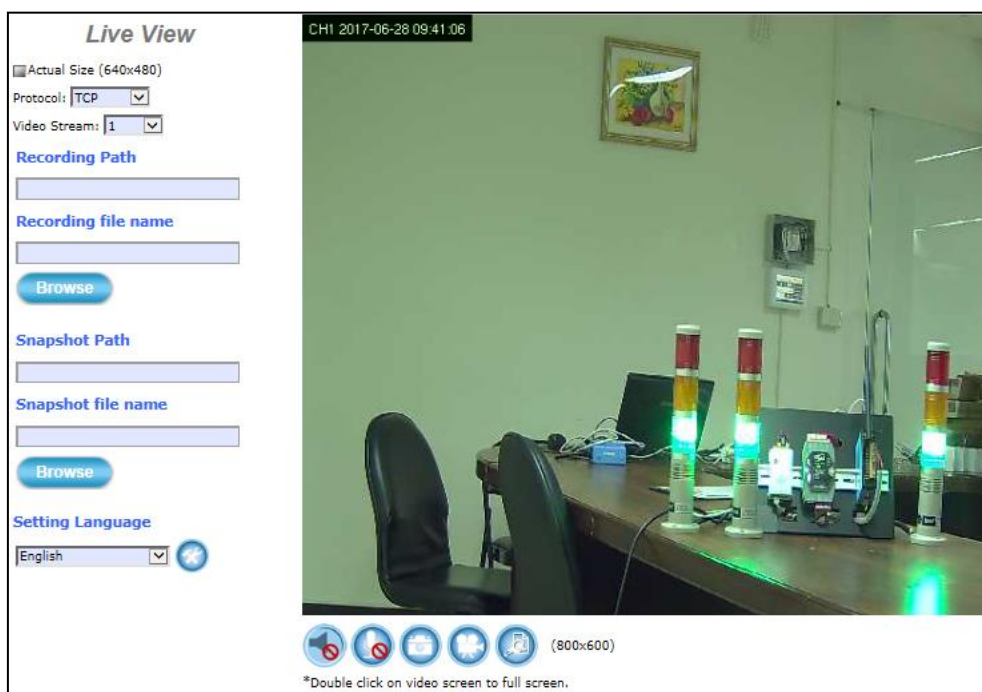

Verify and Complete the Installation from Your Browser

If your IE Browser can't get the ActiveX download properly, you may have to temporarily lower your security settings to perform a one-time-only installation of the ActiveX component onto your workstation, as described below:

1. From the IE Browser menu, select **[Internet Options] -> [Security] -> [Custom Level]**
2. Set the security level to Low and click **[OK]**.
3. Don't forget to restore the security level after the ActiveX installation.

3 Live View UI Settings

In this chapter, you may change and reconfigure the Camera Live View UI (User Interface) to suit your need via PC/notebook.

First, open the Camera Web UI by the below steps, or refer to [Chapter 2.3.2 Camera Live View UI Setting Tools](#) for detail descriptions.

- 1) Execute your Web Browser and then manually enter the Camera Device's IP address gotten via **CAM FINDER** utility.



NOTE

- For the first time user, there will be a prompt to install the ActiveX control. Comply with the ActiveX installation as it is needed to view the video stream and some other operations.
- Use of Microsoft IE browser is recommended as it offers a better compatibility.

- 2) Then the “Windows Security” dialog displays. Enter a username and password. You may enter “**admin**” for both. Click **OK** button when completed.



(**Note that same Browser with different version or different vendor Browser will behave different dialog window. Below picture is belonging to IE Browser's diagram.**)





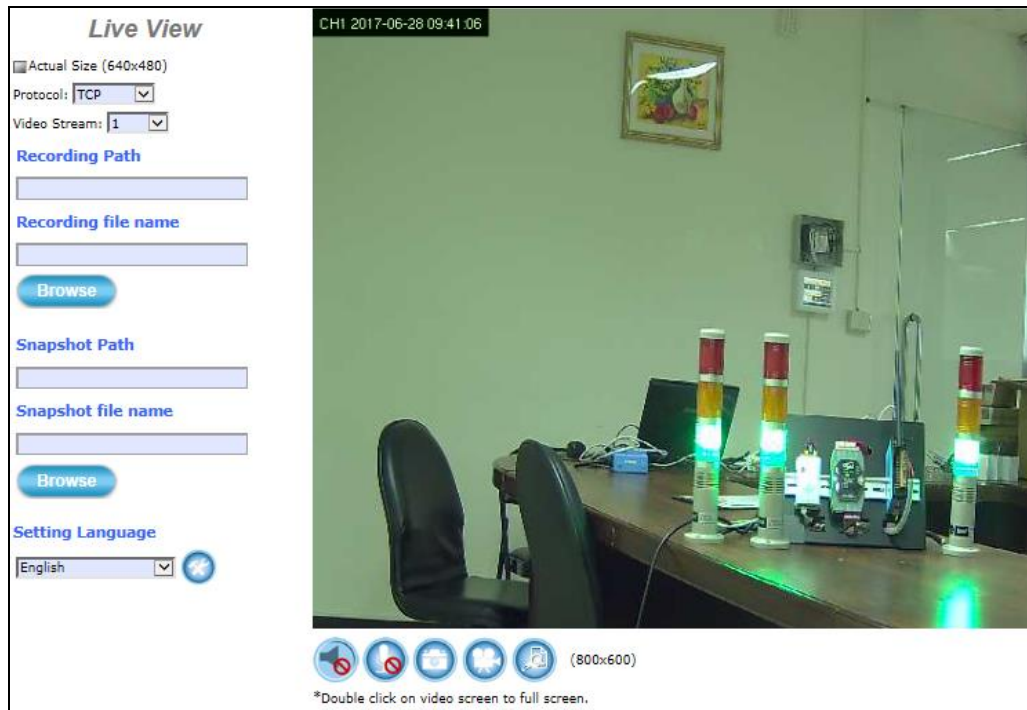



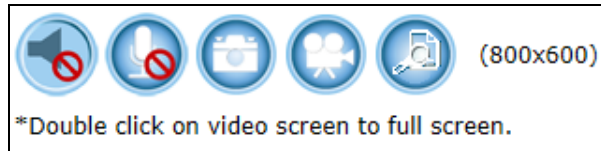

- 3) The “Live View” setting window will then display offering all the necessary set up tools for changing the live view reconfigurations. The functions of each of these tools are explained in the following sections.



3.1 Quick Access Buttons

The following buttons provide the basic interactive functions between the Camera and the host computer as described below.

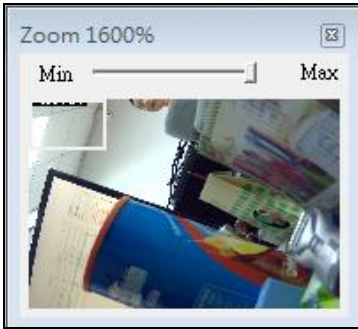

 	<p>Mute: Click this button to turn on/off the Windows speaker of the host computer/NB. If turn it to the “Mute” status, the ActiveX will not let the IP CAM voice stream output to the Speaker of the PC/NB.</p>
 	<p>Chatting: Click this button to enable/disable Chatting function to someone facing the network Camera from the computer. For ideal voice reception, the distance of the person on view, should be kept within 2 meters from the Camera.</p>
	<p>Snapshot: Click this button to capture still images taken from the Camera and save them in the host computer/NB.</p>
	<p>Record: Click this button to record live video clips from the Camera into your computer/NB.</p>
	<p>Digital Zoom: Digital “zoom in” & “zoom out” to the particular area of the live view; and the particular area also could be moved wherever you want to see. To display the whole live view into full screen mode, double click the mouse left button on the video; and press “ESC” key on the keyboard could exit full screen view.</p> 

3.2 Camera Live View UI Setting Tools

The **Live View** UI setting tools (the below figure) offer a variety of methods in changing the live view configurations of the Camera.

Overview of Live View UI

Live View

Actual Size (2048x1536)

Protocol: TCP ▼

Video Stream: 1 ▼

Recording Path

Recording file name

Browse

Snapshot Path

Snapshot file name

Browse

Setting Language

English ▼

Actual Size / Protocol / Video Stream:
Choice the size, protocol and video stream.

Recording Path / Recording file name:
Specify a storage destination path for the video and define a base filename for the video you are going to record.

Snapshot Path / Snapshot file name:
Specify a storage destination path for the snapshot images and define a base filename for the snapshots you are going to capture.

Setting Language:
Select the default language of the user-interface.

Setup button:
Click **Setup** button can change or update more Camera settings, including Video & Audio, System, Network, Event, Local Storage and Remote Storage.

Figure 3-4 Camera Live View Reconfiguration Tools

iCAM-721F User's Manual ICP DAS

26

■ **Actual Size / Protocol / Video Stream:**

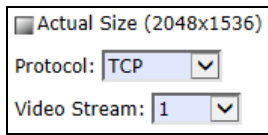

Actual Size: Check to show the live view display resolution in actual size (2048 x 1536). The default is in “uncheck” status (800 x 600).

Protocol: Option for TCP, UDP or HTTP transmission protocol with H.264/MPEG4 streaming is available.

Video Stream: Two simultaneous streaming is supported for live viewing.

■ **Recording / Snapshot:**

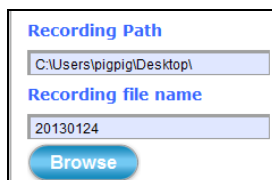

Browse: Click **Browse** button to define Recording Path and Recording Filename for the video you are preparing to record.

Recording Path: Specify a storage destination path for the video you are going to record.

Recording file name: Define a base filename for the video recordings you are going to take. EX: set as “office123”. It will auto-expand date & time for each saved video filename as “office123 _20170510_102808.avi”.



: To start recording, click the **Recording** button in the Quick Access Button area.

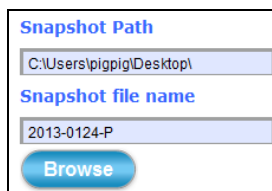

Browse: Click **Browse** button to define Snapshot Path and Snapshot Filename for the snapshots you are preparing to capture.

Snapshot Path: Specify a storage destination path for the snapshot images you are preparing to capture.

Snapshot file name: Define base filename for the snapshots you going to capture. EX: set as “night456”. It will auto-expand date & time for each saved snapshot file as “night456 _20170510_102808.jpg”.



: To start capturing snapshots, click the **Snapshot** button in the Quick Access Button area.

■ Setting Language:

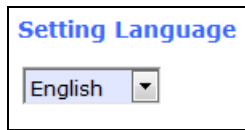

Setting Language: Select the default language of the user-interface.

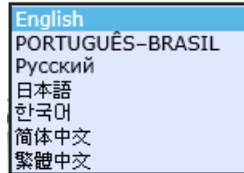

■ Setup:



Setup: Click **Setup** button can change or update more Camera settings, including Video & Audio, System, Network, Event, Local Storage and Remote Storage.

As you get familiar with features and functions of your Camera, you may want to change or update a number of its settings to further upgrade its performance. This can be accomplished by clicking the **Setup** button (indicated in the above figure). The **Setup** dialog (see following figure) will then display to provide the range of setup categories you will be able to change.

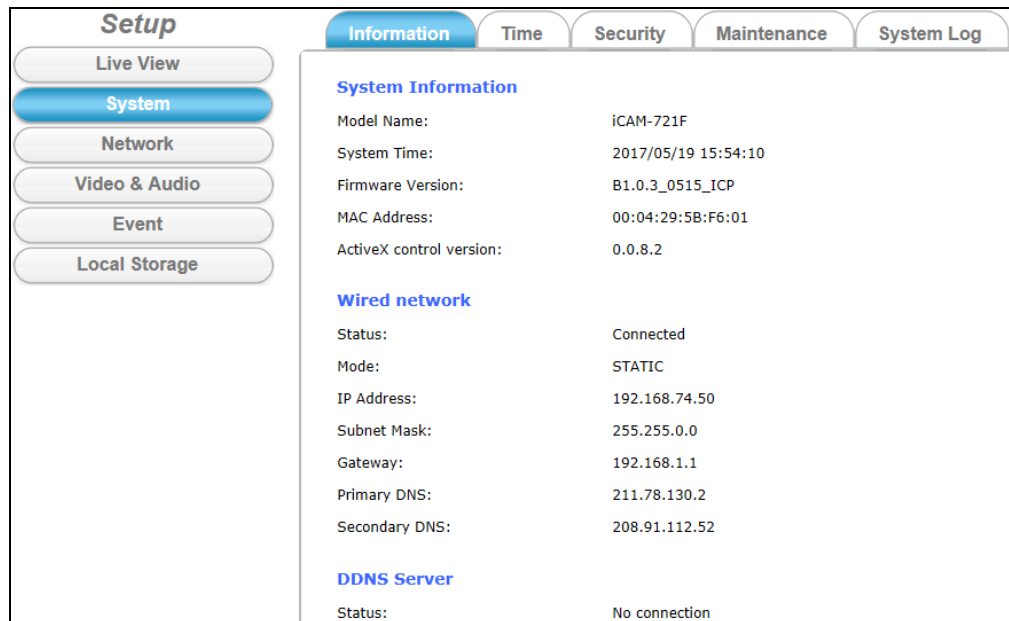
A screenshot of the "Setup" dialog box. The "Setup" title is at the top left. Below it are several buttons: "Live View", "System" (highlighted in blue), "Network", "Video & Audio", "Event", and "Local Storage". To the right, there are tabs for "Information", "Time", "Security", "Maintenance", and "System Log". The "Information" tab is active, showing "System Information" and "Wired network" sections. The "System Information" section includes fields for Model Name (iCAM-721F), System Time (2017/05/19 15:54:10), Firmware Version (B1.0.3_0515_ICP), MAC Address (00:04:29:5B:F6:01), and ActiveX control version (0.0.8.2). The "Wired network" section shows Status (Connected), Mode (STATIC), IP Address (192.168.74.50), Subnet Mask (255.255.0.0), Gateway (192.168.1.1), Primary DNS (211.78.130.2), and Secondary DNS (208.91.112.52). Below that is the "DDNS Server" section with Status (No connection).

4 Setup

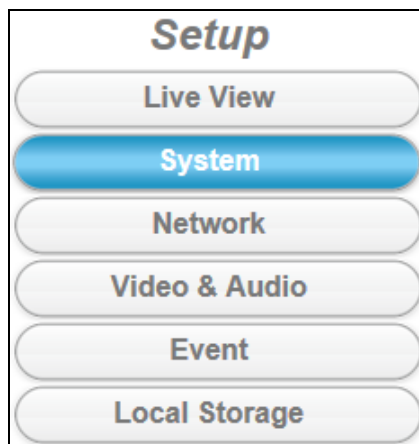

NOTE

For “Live View” setup execution, please refer to the previous chapter “Live View UI Settings”

4.1 System Setup

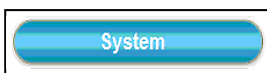

Clicking the **System** button will display the following tabbed panes relative to system configurations.

Setup

- Live View
- System**
- Network
- Video & Audio
- Event
- Local Storage

Information | Time | Security | Maintenance | System Log

System Information

Model Name:	iCAM-721F
System Time:	2017/05/19 15:54:10
Firmware Version:	B1.0.3_0515_ICP
MAC Address:	00:04:29:5B:F6:01
ActiveX control version:	0.0.8.2

Wired network

Status:	Connected
Mode:	STATIC
IP Address:	192.168.74.50
Subnet Mask:	255.255.0.0
Gateway:	192.168.1.1
Primary DNS:	211.78.130.2
Secondary DNS:	208.91.112.52

DDNS Server

Status:	No connection
---------	---------------

4.1.1 Information Tab

Information	Time	Security	Maintenance	System Log
System Information				
Model Name:	iCAM-721F			
System Time:	2017/05/19 15:54:10			
Firmware Version:	B1.0.3_0515_ICP			
MAC Address:	00:04:29:5B:F6:01			
ActiveX control version:	0.0.8.2			
Wired network				
Status:	Connected			
Mode:	STATIC			
IP Address:	192.168.74.50			
Subnet Mask:	255.255.0.0			
Gateway:	192.168.1.1			
Primary DNS:	211.78.130.2			
Secondary DNS:	208.91.112.52			
DDNS Server				
Status:	No connection			

The **Information** tabbed pane provides the existing system status of the Camera which includes Model Name, System Time, Firmware Version, MAC Address, ActiveX Control Version, Wired Network, Wireless Network and DDNS Server Status.

4.1.2 Time Tab

System Time
2017/05/19 16:44:11

System Time settings

Time Zone:
GMT+08:00 Beijing, Chongqing, Hong Kong, Kuala Lumpur, Singapore, Taipei, Krasnoyarsk

Automatic

NTP server: pool.ntp.org

Keep current date and time

Set Manually

Synchronize with computer time

Date: 2017/05/19 Time: 16:42:14

Assign value

Enable Daylight Saving

Offset: +1 hrs

	Month	Week	Day of week	Hour	Minute
Start time	8	1	sunday	0	0
End time	10	1	sunday	0	0

Save

The **Time** tabbed pane is where you set up the clock of your Camera to synchronize with your local time. Where:

System Time: The Network Camera current date and time is applied and displayed here based on the setup status of the System Time Settings as detailed below.

Time Zone: Select the applicable Time Zone of your city in reference to Greenwich Mean Time.

Automatic: Select this item if you want to automatically synchronize the Camera clock with your manually entered Network Time Protocol (NTP) Server.

Keep current date and time setting: Select this option in lieu of automatic synchronization if the Camera is not connected to NTP Server and uses its own embedded clock.

Set Manually:

Ⓒ **Synchronize with the computer Time:** Select this option to manually synchronize the Network Camera clock (date and time) with that of the local host computer.

Ⓒ **Assign value:** Select this option to enter the date and time manually.

Enable Daylight Saving: Select this option only when applicable at your location. Two setup settings; the **Start time** and **End time** are needed to implement the feature.



After setups are completed, click **Save** button to apply the settings.

4.1.3 Security Tab

The screenshot shows a web interface with five tabs: Information, Time, Security (selected), Maintenance, and System Log. Below the tabs is a section titled "Security" containing a "User List" table. The table has two columns: "User Name" and "User Group". It lists two users: "admin" with the group "Administrator" and "ipcam" with the group "Operator". Below the table are two buttons: "Add" and "Remove".

User Name	User Group
admin	Administrator
ipcam	Operator

The **Security** tabbed pane allows you to add new Camera User Name and change Password and the surveillance status or User Group.

Where:



User List: The **admin/Administrator** user list is a permanent default setting and cannot be removed nor changed. Hence, new User Name/Group settings are only added below the default setting.

Add: Click **Add** button can expand the security setup items to access and change the security setting status.

Remove: Click **Remove** button can remove the added security setting.

Click the **Add** button to access the security setup dialog (shown below).

User Setup

User Name:

Password: Show Password

Confirm Password:

User Group:

Administrator

Operator

Viewer

Note:

1. A user name and password must contain at least one character.
2. Max 14 characters are allowed in user names.
3. The first character in user name must be A-Z or a-z.
4. Only A-Z, a-z and 0-9 are allowed in the user name and password.
5. Max eight characters are allowed in the password.
6. The maximum number of users is 20.
7. The 'admin' user is default user and cannot be deleted.

User Name: Enter the new user name to be added into the list (see Note 4 of dialog for proper entry).

Password: Enter the new password (see Note 4 of dialog for proper entry).

Confirm password: Enter the password again for authentication (encoded display).

Show Password: Displays the decoded password when check box is enabled.

User Group: Three group options are available, namely:

- Ⓒ **Administrator:** User is allowed to change Camera settings and perform all Camera functions.
- Ⓒ **Operator:** User is allowed to login “Live View” Webpage and perform all functions within this page. Except changing Video and Audio settings of Camera live stream, other adjustments of Camera parameter are prohibited.
- Ⓒ **Viewer:** User is only allowed to login “Live View” Webpage and perform all functions within this page. Changing Camera settings is prohibited.



After setups are completed, click **Save** button to apply the settings.

4.1.4 Maintenance Tab

Information Time Security **Maintenance** System Log

Model Name: iCAM-721F
Firmware Version: B1.0.3_0515_ICP

Remote Upgrade Firmware

Server URL:

Auto Upgrade

New Version: No

Local Upgrade Firmware

Select firmware file:

Upload Own Logo File

Right click the mouse button on 'Logo Image' (nlogo.png 165x50) and then select Save As to save image in the PC.

Select image file to upload:

Backup

Save all parameters and user-defined scripts to a backup file.

Upload Setting

Use a saved backup file to return the unit to a previous configuration.

Specify the backup file to use:

Reboot System

Restore System

The **Maintenance** tabbed pane allows you to upgrade the firmware with the latest version and to restore the Network Camera settings to factory default.



※ Please specify the correct firmware version mapped with your camera to upgrade, or there will be danger to damage camera system.

Local Upgrade Firmware: Download the latest firmware file from the website by executing the following steps:

Upgrade

- 1) Click the **Browse** button to access and select the **appropriate** firmware file from its folder.
- 2) Click the **Upgrade** button. The Network Camera will then start to upgrade the existing firmware.

When upgrade is completed, the Camera will reboot automatically.

※ **In Appendix 5.1 chapter, there will be more detailed steps to guide you how to update camera firmware step by step and trouble shooting.**

Backup: Clicking the **Backup** button allows you to manually save Camera's parameters and user settings into a **config_backup.tar.gz** file.

Upload Setting: This function allows user to restore Camera's backup setting by executing the below steps:

Restore

- 1) Click the **Browse** button to access and select saved **config_backup.tar.gz** file from the PC.
- 2) Click the **Restore** button to process Camera configuration restore.

Reboot

Reboot System: Clicking the **Reboot** button allows you to manually reboot the Network Camera.

Factory Default

Restore System: Clicking the **Factory Default** button will restore the Network Camera to its factory default settings status. Before Camera system proceed to restore step, there'll be a dialog window popped and then ask if you would like to keep "**Network setting**" parameters. Besides, all configured data in the "**System Time**", "**Security**" and "**Maintenance**" tab will be remained current.

4.1.5 System Log Tab

The screenshot shows a web interface with five tabs: Information, Time, Security, Maintenance, and System Log. The System Log tab is active. It contains a 'System Log' title, a 'Logs' link, and a 'Remote Log Settings' section. The settings include a checkbox for 'Enable remote log', a text input for 'Log server IP address', a text input for 'Server Port' with '(0..65535)' next to it, and a 'Status' field showing 'disconnected'. A blue 'Save' button is at the bottom left.

The **System Log** tabbed pane allows you to see Camera’s basic log on another browser page or Remote Log Server.

Where:

Logs: Click “**Logs**” and then there will be another browser page opening and then displaying Camera’s basic log lists.

Remote Log Settings: Check “Enable remote log” selection first; and then manual entering IP address & port setting of Remote Log Server.

Status: The connected or disconnected of **Status** tell you if the IP Address of Remote Log Server is existence or not.

Save

After setups are completed, click **Save** button to apply the settings.

Then **Status** would shows “connected” or “disconnected”.

4.2 Network Setup

 Clicking the **Network** button will display the following tabbed panes on configuring Camera connection with the network.

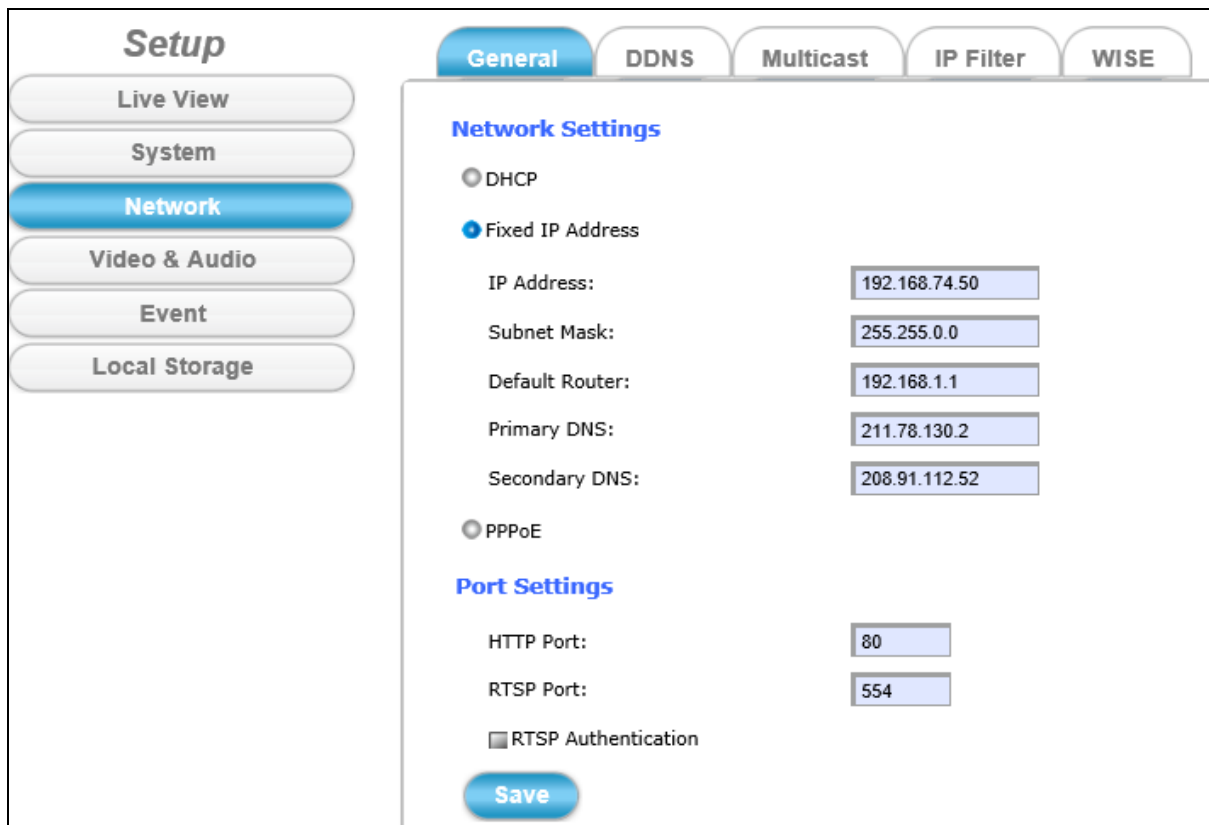

The screenshot shows a web-based configuration interface for a camera. On the left is a 'Setup' sidebar with buttons for 'Live View', 'System', 'Network' (highlighted in blue), 'Video & Audio', 'Event', and 'Local Storage'. The main area has a 'General' tab selected, with other tabs for 'DDNS', 'Multicast', 'IP Filter', and 'WISE'. Under 'Network Settings', 'Fixed IP Address' is selected, and fields are filled with: IP Address: 192.168.74.50, Subnet Mask: 255.255.0.0, Default Router: 192.168.1.1, Primary DNS: 211.78.130.2, and Secondary DNS: 208.91.112.52. Under 'Port Settings', HTTP Port is 80 and RTSP Port is 554. There is an unchecked checkbox for 'RTSP Authentication' and a 'Save' button at the bottom.

Field	Value
IP Address	192.168.74.50
Subnet Mask	255.255.0.0
Default Router	192.168.1.1
Primary DNS	211.78.130.2
Secondary DNS	208.91.112.52
HTTP Port	80
RTSP Port	554

4.2.1 General Tab

The screenshot shows the 'General' tab selected in a settings menu. The tabs are 'General', 'DDNS', 'Multicast', 'IP Filter', and 'WISE'. Under 'Network Settings', 'Fixed IP Address' is selected. The fields are: IP Address (192.168.74.50), Subnet Mask (255.255.0.0), Default Router (192.168.1.1), Primary DNS (211.78.130.2), and Secondary DNS (208.91.112.52). Under 'Port Settings', HTTP Port is 80, RTSP Port is 554, and RTSP Authentication is unchecked. A 'Save' button is at the bottom.

The **General** tabbed pane (shown above) allows you to redefine the network and port protocol settings of the Network Camera.

Where:

Network Settings:

- Ⓒ **DHCP:** This option obtains the available dynamic IP address assigned by the DHCP server each time the Camera is connected to the network.
- Ⓒ **Fixed IP Address:** This option manually assigns a static IP address to the Network Camera.

Ⓒ **PPPoE:** Select this option to set PPPoE account & password.

PPPoE

PPPoE User Name:

PPPoE Password:

Recipient E-mail Address: (ex: rcpt@mail.com)

SMTP E-mail Server: (ex: mail.examples.com or 192.168.1.1)

SMTP Port: (0..65535)

SMTP user name:

SMTP Password:

Sender E-mail Address: (ex: from@mail.com)

Use SSL-TLS: ▾

Port Settings

HTTP Port:

RTSP Port:

RTSP Authentication

While PPPoE protocol is selected, you may have to enter some more information such as the above picture.

While Camera IP is changed dynamically because of PPPoE Network Connection, its new IP Address will be sent to “Sender E-mail Address” through SMTP service. So you won’t worry about the difficulty in Camera’s Webpage access.



※ As for the settings of SMTP Service, kindly please contact with your E-mail service provider ◦ After you confirm all parameters are correct and working properly, you may enter them into the text area manually.

Port Settings:

- Ⓒ **HTTP Port:** Re-define the existing HTTP Port number in the text box.
- Ⓒ **RTSP Port:** Re-define the existing RTSP Port number in the text box.



After setups are completed, click **Save** button to apply the settings.

4.2.2 DDNS Tab

一般 DDNS 群播 IP 過濾 WISE

動態DNS設定

DDNS啟用

提供者: dyndns.com

鏈接 <http://www.dyndns.com>

主機名稱: hostname
(例: ddns.test.com)

使用者名稱: username

密碼: ●●●●●●
 顯示密碼

更新時間: 1000 (600~86400 秒)

狀態: 無連線

儲存

The **DDNS** tabbed pane allows you to configure the Dynamic Domain Name System of your network device with a host name instead of the IP Address.

Where:

DDNS Enable: Enable the check box to support DDNS function.

Host Name: Enter the Host name which you registered and got through DNS Service Provider. The assigned host name is used to access the network device instead of IP Address.

User Name/Password: Account authentication for logging into the website of DNS Service Provider.

Show Password: Enabled check box to display password in decoded format.

Update Time: Define a time interval for the device to periodically update and check its access status with website of DNS Service Provider.

Save

After setups are completed, click **Save** button to apply the settings.

4.2.3 Multicast Tab

Multicast Settings (Based on the RTSP Server)

Multicast Group Address: (224.3.1.0 ~ 239.255.255.255)

Multicast Port: (1 ~ 65535)

Multicast TTL: (1 ~ 255)

Stream 1 ←

Enable

Multicast Video Port: 5560

Multicast Audio Port: 5562

Multicast Metadata Port: 5564

Stream 2 ←

Enable

Multicast Video Port: 5566

Multicast Audio Port: 5568

Multicast Metadata Port: 5570

Stream 3 ←

Enable

Multicast Video Port: 5572

Multicast Audio Port: 5574

Multicast Metadata Port: 5576

Check the "Enable" box to open **UDP Multicast Streaming** function of stream1, 2 or 3.

The **Multicast** tabbed pane allows you to open Camera's UDP Multicast Streaming function.

By default, Camera's live stream belongs to RTSP Protocol. It means camera has to send an individual streaming for each client wish to see the videos. So the more the client number is, the larger the network bandwidth required and the bigger loading of the camera.

In other words, the camera can send just one streaming and each client can receive the streaming with Multicast Protocol.

Even with the client number increasing, the network bandwidth is still the same loading with one camera.

Enable: Check the “Enable” box to open **UDP Multicast Streaming** function of stream.



After checking the “Enable” box to open this function, click **Save** button to apply the settings.

4.2.4 IP Filter Tab

The **IP Filter** tabbed pane could let you configure device IP list which is denied access to this camera.



Where:

Start IP address: Fill in the first address of IP range which you would like to deny its access to camera.

End IP address: Fill in the last address of IP range which you would like to deny its access to camera.



※ please note that total device numbers listed in the Deny list would be limited to 20.



Filling the IP range, then click **Save** button to implement the settings.



If you would like to re-open the access right of those listed device, select it from the list and then click **Remove** button to apply the settings.

4.2.5 WISE Tab

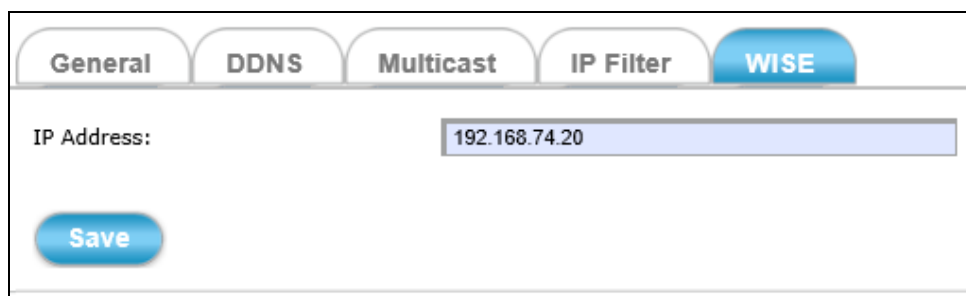

The screenshot shows a web interface with five tabs: General, DDNS, Multicast, IP Filter, and WISE. The WISE tab is selected and highlighted in blue. Below the tabs, there is a label "IP Address:" followed by a text input field containing the IP address "192.168.74.20". A blue "Save" button is located below the input field.

The **WISE** tabbed pane allows you to communicate the iCAM camera with WISE controller to perform a WISE surveillance system.

ICP DAS WISE surveillance solution integrates logic control, I/O, camera and data log in one single WISE controller. WISE allows two-way interactions between the I/O and the camera; it enables to record a piece of video or to take images when there is an event triggered by either I/O condition or ROI (Region of Interest) by camera. In this way, the storage size can be reduced significantly and the connection between I/O event and Video/Image can be built for easy query. Refer to http://www.icpdas.com/en/product/guide+IIoT+IO_Sensor+WISE_I_O_Module#564.

Where:

IP Address: Fill in the IP address of WISE-5231.
When the IP address is set, the CGI command is automatically sent to the WISE-5231 when an event occurs in this camera.



After setups are completed, click **Save** button to apply the settings.

4.3 Video & Audio Setup

Video & Audio

Clicking the **Video & Audio** button will display the following tabbed panes for defining Camera streaming, video, and audio functions.

The screenshot displays the 'Video & Audio' setup interface. On the left is a 'Setup' sidebar with buttons for 'Live View', 'System', 'Network', 'Video & Audio' (highlighted), 'Event', and 'Local Storage'. The main area has tabs for 'Stream', 'Video', 'Audio', 'Privacy Mask', and 'ROI'. The 'Stream' tab is active, showing three configuration sections for 'stream 1', 'stream 2', and 'stream 3'. Each section includes settings for connection template, mode, frame size, maximum frame rate, streaming mode, bitrate, intra frame period, text overlay, text field, time stamp, and RTSP port access name. A 'Save' button is located at the bottom.

Stream	Connection template	Mode	Frame Size	Maximum Frame Rate	Streaming Mode	Bitrate	Intra frame period	Text Overlay	Text Field	Time Stamp	RTSP Port Access Name
stream 1	Customized	H264	2048x1536	15 FPS	CBR(CVBR)	8 Mbps	15	<input checked="" type="checkbox"/>	CH1	<input checked="" type="checkbox"/>	live1.sdp
stream 2	Customized	H264	1280x960	15 FPS	CBR(CVBR)	2 Mbps	15	<input checked="" type="checkbox"/>	CH2	<input checked="" type="checkbox"/>	live2.sdp
stream 3	Customized	H264	640x480	15 FPS	CBR(CVBR)	768 Kbps	15	<input checked="" type="checkbox"/>	CH3	<input checked="" type="checkbox"/>	live3.sdp

4.3.1 Stream Tab

The screenshot displays the 'Stream' tab of a configuration interface. It features five sub-tabs: 'Stream' (selected), 'Video', 'Audio', 'Privacy Mask', and 'ROI'. The main content area is divided into three sections, each titled 'Video quality settings for stream X' (where X is 1, 2, or 3). Each section contains a list of settings with corresponding input fields or dropdown menus. The 'Stream 1' section includes settings for Connection template (Customized), Mode (H264), Frame Size (2048x1536), Maximum Frame Rate (15 FPS), Streaming Mode (CBR(CVBR)), Bitrate (8 Mbps), Intra frame period (15), Text Overlay (checked), Text Field (CH1), Time Stamp (checked), and RTSP Port Access Name (live1.sdp). The 'Stream 2' section includes settings for Connection template (Customized), Mode (H264), Frame Size (1280x960), Maximum Frame Rate (15 FPS), Streaming Mode (CBR(CVBR)), Bitrate (2 Mbps), Intra frame period (15), Text Overlay (checked), Text Field (CH2), Time Stamp (checked), and RTSP Port Access Name (live2.sdp). The 'Stream 3' section only shows the Connection template (Customized) setting.

The **Stream** tabbed pane (see above figure) provides the adjustments for the video quality of the Camera streaming function.

The pane offers the following three modes of video quality setting:

Video quality settings for stream 1: This is the primary quality setting for live view streaming.

Video quality settings for stream 2: This is the secondary quality setting for live view streaming.

Video quality settings for stream 3 : This is the third quality setting for live view streaming.



NOTE

*If the “Video Event Alarm Setting by Video” in the Section 4.4.2 is enabled, an alert message will display requiring you to disable the feature first before proceeding to change the Streaming settings. Otherwise, adjustments to video quality streaming settings **cannot** be accomplished.*

The screenshot shows a configuration interface for video quality settings. At the top, there are five tabs: 'Stream', 'Video', 'Audio', 'Privacy Mask', and 'ROI'. The 'Video' tab is selected. Below the tabs, the title is 'Video quality settings for stream 1'. The settings are as follows:

- Connection template: Customized
- Mode: H264
- Frame Size: 2048x1536
- Maximum Frame Rate: 15 FPS
- Streaming Mode: CBR(CVBR)
- Bitrate: 8 Mbps
- Intra frame period: 15
- Text Overlay
 - Text Field: CH1
- Time Stamp
- RTSP Port Access Name: live1.sdp

The quality setting items on this pane are as follows:

Connection template: Four option modes are available; “Fast,” “General,” “Low,” and “Customized” modes.

Mode: Three modes of encoding options are offered; “H264,” “MJPEG,” and “MPEG4.”

Frame Size: Many sizes of streamed frame resolutions are available for selection: from “2048x1536”, “1920x1080”, “1600x1200”... to “320x180”.

Maximum Frame Rate: Available rate options are: 1, 2, 3, 5, 8 ... 30 frames per second (FPS), 1080P Full HD available for 30 FPS

Steaming Mode: Three choices of streaming modes are offered; “CBR (CVBR)”, “CBR (VQCB)” and “VBR (variable bit rate)”.

CVBR - If the provided bit rate is not exceeded, the video is encoded with provided quality factor. If it exceeds, the video quality will be varied to meet the provided bit rate while the frame rate is kept constant.

VQCB - The video quality and the frame rate will be variable to meet the provided bit rate.

The options for streaming mode quality are expressed differently between choosing VBR and CBR:

- © **Quality:** Function displayed if chooses “VBR”. Three options: Standard, Good, & Detailed.
- © **Bitrate:** Function displayed if chooses “CBR”. 64K bps, 128K bps, 184K bps, 200K bps, 256K bps, 384K bps, 512K bps, 768K bps, 1M bps, 1.5M bps, 2M bps, 3M bps, 4M bps, 5M bps, 6M bps, 8M bps and 10M bps.

Intra frame period: Available choices are; 5, 8, 10, 15, 20, 25, 30, 40, 50 & 60 frames per period. This function will let you choose how long distance between two I-Frames.

Lager value means longer distance between two I-Frames and this selection is suitable for the stable Network Bandwidth Environment; so we suggest the smaller value selection is proper to the worse Network Bandwidth Environment.

The screenshot shows a configuration panel with the following elements:

- Intra frame period:** A dropdown menu with the value '15' selected.
- Text Overlay:** A checked checkbox.
- Text Field:** A text input field containing 'CH1'.
- Time Stamp:** A checked checkbox.
- RTSP Port Access Name:** A text input field containing 'live1.sdp'.

Text Overlay: When enabled, each streamed frame will be overlaid with the Camera ID (text field) and stamped with date/time (if enabled) as illustrated below.

RTSP Port Access Name: When RTSP or VLC media-player is used, the port can be renamed with easy to remember pathname. For example: the default RTSP Port Access Name is live1.sdp ; it means your stream name would be “RTSP://camera’s IP address/live1.sdp”



After setups are completed, click **Save** button to implement the settings.

4.3.2 Video Tab

Stream
Video
Audio
Privacy Mask
ROI



Video Settings

Day / Night Mode: Day ▾

Template: General ▾

Brightness: 100 (0~200)

Saturation: 100 (0~200)

Contrast: 100 (0~200)

Sharpness: 100 (50~200)

Exposure Lock: Auto Lock

Shutter Speed: 1/ 30 ▾ second(s)

Gain: 512 (1~512) [Slow~Fast]

Power Frequency: 50 Hz 60 Hz

EV Compensation: 100 (50~200)

2D Noise Reduction

Normal Strength: 100 (0~200)

Wide Dynamic Range: Enable Disable

White Balance: Auto ▾

Video Orientation: Flip Mirror

Target Luminance: 60 (0~255)

Advanced Settings

Color/Mono Mode: Auto Color Mono

Day / Night Threshold: 10 (5~100)

ICR: Auto On Off

IR LED: Auto On Off

Schedule

The **Video** tabbed pane lets you to perform live adjustments and improvement of the Camera captured video effect relative to the target environment.

Where:

Template: That means you can select what environment to use for base on your scenario. There are four kinds of template to choose.
General/Outdoor/WDR/Night Speed Mode

Brightness: The luminance of the captured image apart from its hue or saturation. Try to assign the fit value according to the environment

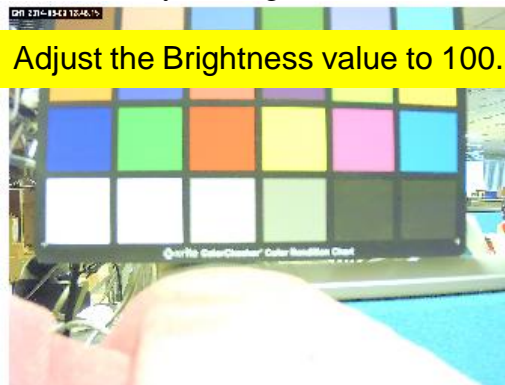

Saturation: The degree of intensity and purity of a specific color. Try to assign the fit value according to the environment.



Contrast: The brightness ratio of the lightest to the darkest part of the video image. Try to assign the fit value according to the environment.

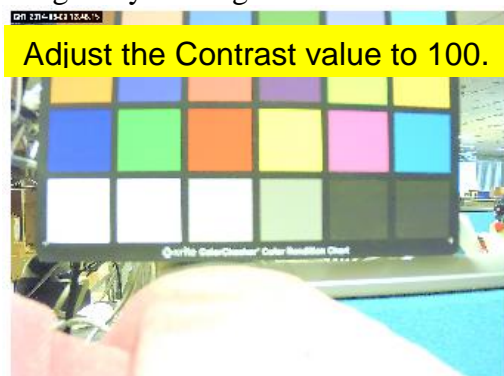

Sharpness: Sharpness can be defined as edge contrast. So when we increase sharpness, we increase the contrast only along/near edges. Try to assign the fit value according to the environment.



EV Compensation: Exposure Compensation is a feature of a camera that allows you to adjust the exposure value manually. You may increase or decrease the amount of brightness or darkness of your picture through sliding the bar. Try to assign the fit value according to the environment.

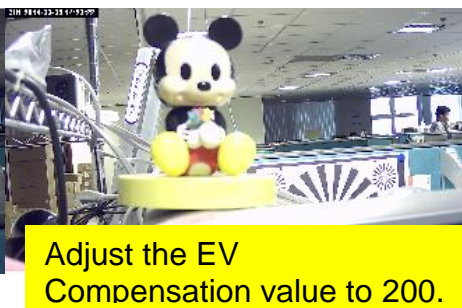

2D Noise Reduction/Pre-Noise Reduction: Both of them are one kind of technology to provide clearer video with less noise under poor lighting conditions, making it easier to identify people or objects. Try to set them according to the stream quality.

Wide Dynamic Range: Enable this function could let camera provide clear images even under backlighting.



White Balance: Because camera doesn't have ability to automatically adjust different color (temperature) to the environment, six templates are provided to let you choose for different light.

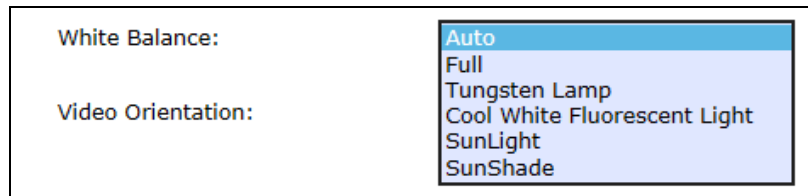

Video Orientation: rotate the image, so it looks up-side down. This can be applied when camera unit must be ceiling mounted and the image is therefore reversed

Day/Night Threshold: Set the illumination lux value (5 ~ 100) to auto-trigger the Camera into "day" or "night" mode relative to luminance of the area under surveillance. When the environment luminance becomes higher than the set lux value, the Camera will auto switch to "day" or "color" mode. Otherwise, it will remain at "night" or "mono" mode with IR.

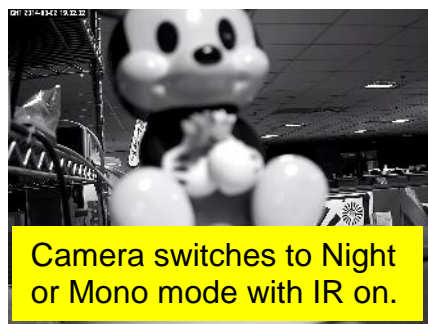

4.3.3 Audio Tab

The screenshot shows a web interface with five tabs: Stream, Video, Audio (selected), Privacy Mask, and ROI. Below the tabs is the 'Audio Settings' section. It contains a 'Type' dropdown menu set to 'G.711 u-Law', a 'Mute' checkbox which is unchecked, and a 'Volume' slider set to 30, with a range of 0 to 80 indicated. A 'Save' button is located at the bottom left of the settings area.

The **Audio** tabbed pane provides the following audio adjustments to your Camera Audio-In port:

- Type:** “G.711 u-Law” or “AAC4”.
- Mute:** Enable or disable mute function of the Camera’s Audio-In signal.
- Volume:** Plug an audio source device into the Audio-In port of camera. And its playback volume could be adjusted by moving the slider to the left to decrease; and to the right to increase the volume.



After setups are completed, click **Save** button to implement the settings.

4.3.4 Privacy Mask Tab

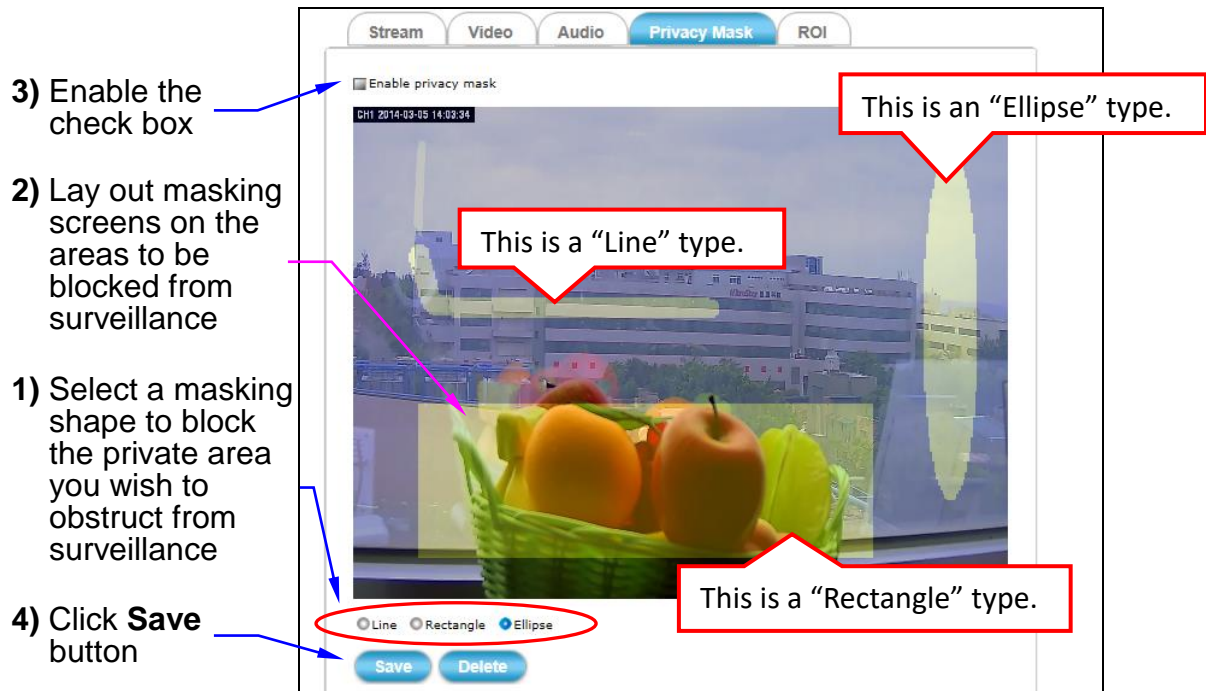

The **Privacy Mask** tabbed pane allows you to mask or block private areas from surveillance for privacy reason.

■ The steps to block a private area from surveillance:

- 1) Select the masking shape, e.g., "Line," "Rectangle," or "Ellipse" (see figure above) you wish to use as screen to block the area from surveillance.
- 2) Click and drag the mouse cursor to lay out a masking screen on the area you wish to block, and then release the mouse right button. Notice that the laid out screen turns into phantom block.
- 3) Once the masking screen is acceptable, click the **Enable Privacy Mask** check box.
- 4) Click the **Save** button. This will turn the laid out screen into solid block. If the laid out screen needs correction, click **Delete** button and redo the masking screen lay out process.



■ **The steps to disable masking and remove the screen:**

- 1) Click **Delete** button.
- 2) Click **Save** button and wait a while. Then the screen is permanently removed.



- 3) To permanently disable the **Privacy Mask** function, disable the **Enable Privacy Mask** check box

4.3.5 ROI Tab

When network capacity is constrained, or there is simply a desire to improve network usage efficiency and storage, clicking the ROI button will display the tabbed panes (see figure below) for defining enhance video quality area of the camera.

■ Set up a single ROI detection area:

- 1) Enable the **Enable** check box.
- 2) Click **Add** button and a default frame will pop-up on the screen.
- 3) Click and hold inside the frame to drag it to the location where you want to focus detection. Resize the frame by dragging its corners or borders.
- 4) Click the **Save** button to apply.

※Only support H.264

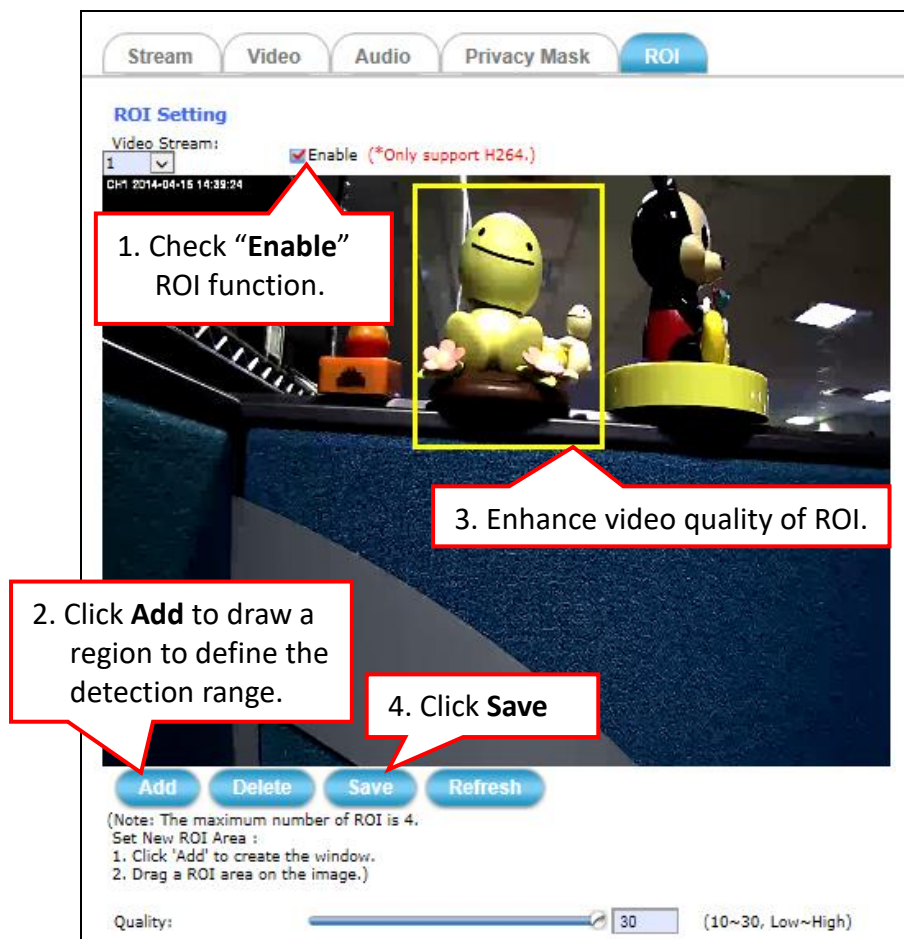

■ Set up multiple ROI detection areas:

- 1) After satisfactory positioning of the first detection area as described above, click the **Add** button again. A second default frame will pop-up on the screen. Drag & resize the frame at the desired location.
- 2) Repeat the above step to add more detection area frames. (Max. 4 frames)

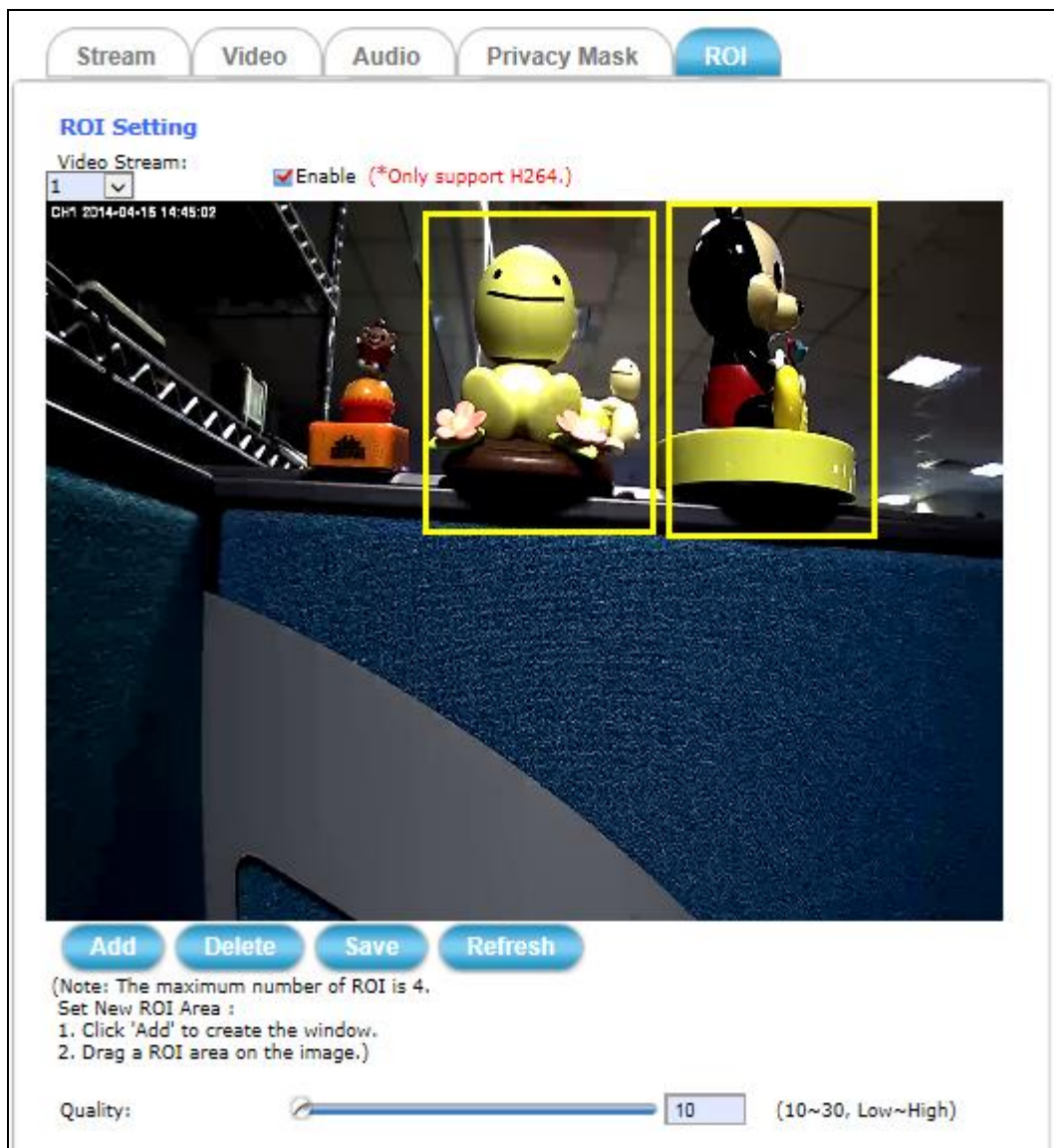

4.4 Event Setup



Clicking the **Event** button will display the tabbed panes (see figure below) for defining event recording of the Camera.

The iCAM-721F is equipped with a card slot for microSD / microSDHC / microSDXC 64 GB memory card.

This storage card is utilized to store recording of local video and still JPEG images taken in response to set events. The recording operation of events is triggered according to the defined schedules.

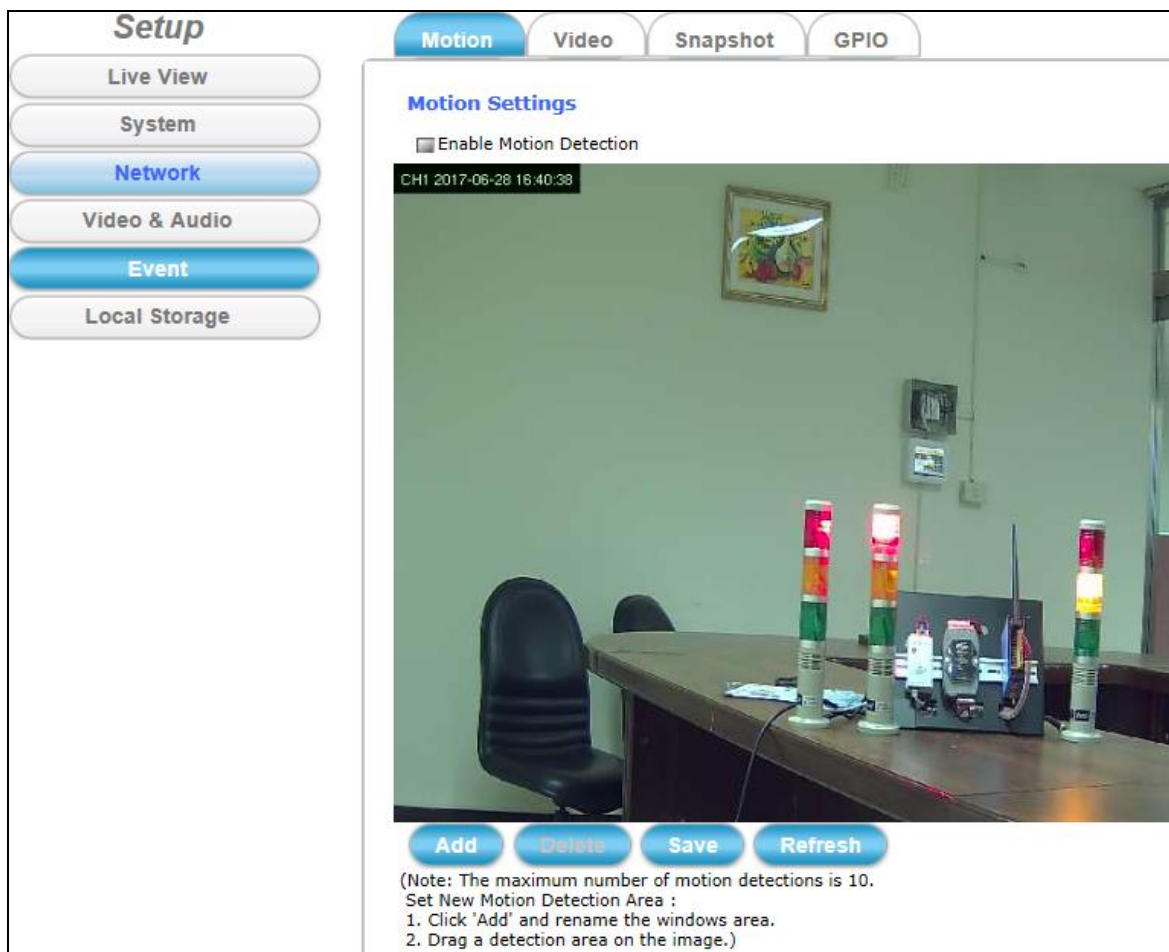

4.4.1 Motion Tab

From the **Motion** tabbed pane, you can define specific target areas within the scope of surveillance to focus the motion detection function.

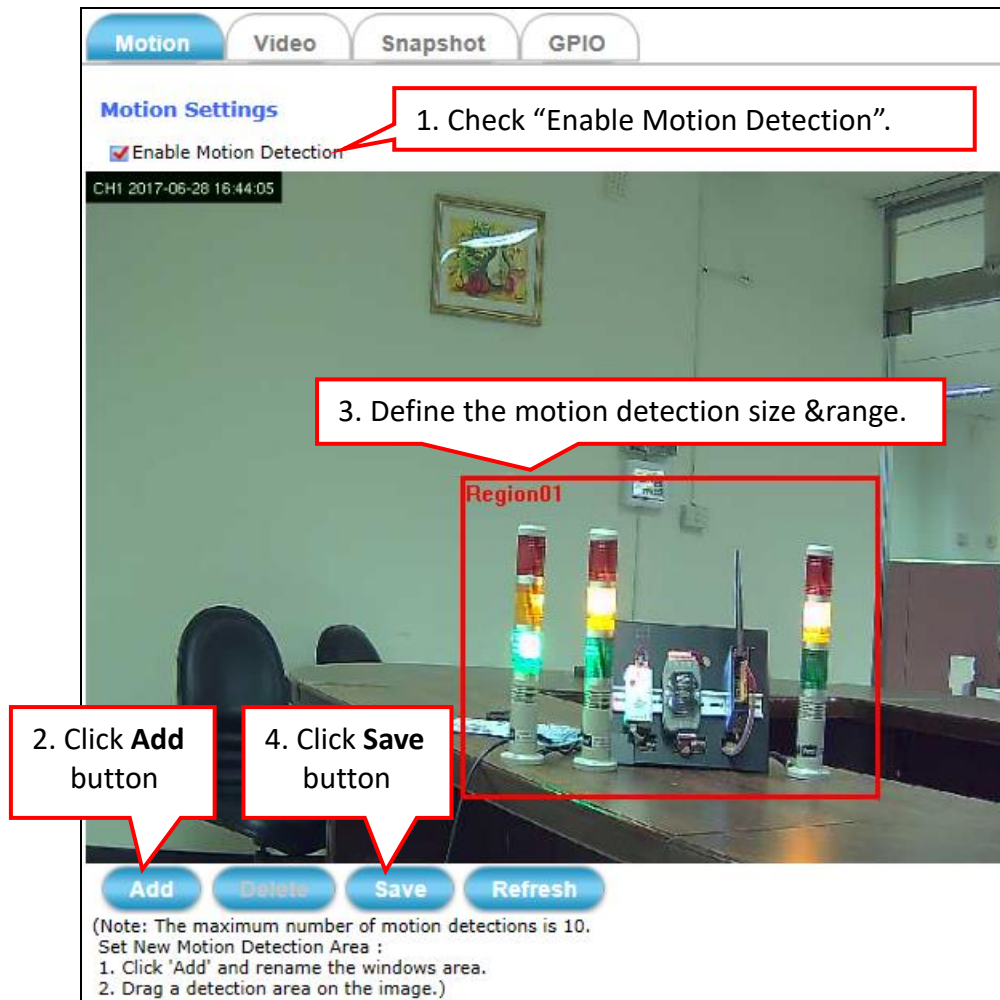

■ Set up the motion detection area:

- 1) Enable the **Enable Motion Detection** check box.
- 2) Click **Add** button and a default **Region01** frame will pop-up on the screen.
- 3) Click and hold the mouse inside the frame to drag it to the location where you want to focus detection. Resize the frame by dragging its corners or borders.
- 4) Click the **Save** button to apply.
- 5) Repeat above steps to add more motion detections. The maximum number of motion detections is 10.



NOTE

Total defined motion detection areas cannot exceed 10 regions.

-
- 6) To assign unique names to each framed location for easy identification, click on the frame and a **Window Name** text box with the default name of the selected frame, will appear at the bottom of the pane (see figure below). Enter a new name and click the **Save** button. Wait for a while for the change to take effect.



The screenshot shows a control panel with three rows. The first row is labeled 'Window Name:' and has a text input field containing 'Region01'. The second row is labeled 'Trigger Level:' and has a slider control with a value of 85 and a range of '(0~100, Low~High)'. The third row is labeled 'Sensitivity:' and has a slider control with a value of 85 and a range of '(0~100, Low~High)'.



- 7) To delete a frame that is no longer needed but was previously saved, click on the unwanted frame and click **Delete** button. The frame will disappear after a while.



- 8) To delete multiple frames that are not yet saved, directly click the **Refresh** button instead of deleting them individually. The **Refresh** button will automatically clear all unsaved frames.

4.4.2 Video Tab

The **Video** tabbed pane sets the video recording trigger method to use when motion event is detected by the Camera.

The methods available for selection:

1. Schedule
2. Period
3. Motion
4. GPIO Input

The settings after event trigger:

1. Recording Length (in seconds)
2. Time Lapse: the duration (in seconds) to detect the motion again.
3. Target: the methods and destination to store the video files.

- **Schedule:** This method activates the Camera video surveillance/recording operation when the defined days of the week and set time of the set days are met. Motion is ignored with this method.

Target: Each recording time is in accordance with the setting value of **Recording Length** (in seconds) and the video record is stored in the **Target** of SD card.

The screenshot shows the 'Video' tab selected in a web interface. The title is 'Event Alarm Settings by Video'. A red warning message states: '(*Please note that there is no SD Card plugged in camera or the SD Card is not writable.)'. Below this, there is a checked checkbox for 'Schedule / Period Recording'. Underneath, 'Schedule' is selected with a radio button. The 'Day:' section has checkboxes for Sun, MON, Tue, WED, Thu, FRI, and Sat, all of which are checked. The 'Time:' section shows a start time of 18:00 (hh:mm) and an end time of 18:01 (hh:mm). The 'Recording Length:' is set to 60 Seconds. The 'Target:' is set to 'SD card'.

-
- **Period:** This method will trigger the Camera video surveillance/recording operation for a defined **Time Lapse** (in seconds) whenever motion is detected.

Target: The video record may be stored in the SD card, provided to host by E-mail / FTP as selected or through all of them.

Motion Video Snapshot GPIO

Event Alarm Settings by Video

(*Please note that there is no SD Card plugged in camera or the SD Card is not writable.)

Schedule / Period Recording

Schedule

Period

Recording Length: Seconds

Time Lapse: Seconds

Target:

SD card

E-mail / FTP

-
- **Motion:** This method will trigger the Camera video surveillance/recording operation whenever motion is detected within the defined days of the week and at the time of the set days.

Each recording time-span is in accordance with the total value of Pre-event recording and Post event recording (in seconds).

Target: The video record may be stored in the SD card, provided to host by E-mail/FTP, activated GPIO Output Port as selected or through all of them.

Event Alarm Settings by Video

(*Please note that there is no SD Card plugged in camera or the SD Card is not writable.)*

Schedule / Period Recording

Motion (Link to [Motion Settings](#))

Trigger Pattern:

Only during

Sun MON Tue WED Thu FRI Sat

Time:

Start 00 : 00 (hh:mm) End 23 : 59 (hh:mm)

Pre-event recording: 10 Seconds

Post event recording: 10 Seconds

Target:

SD card

E-mail / FTP

GPIO Output

-
- **GPIO Input:** On the defined days of the week and at certain time of the set days, the Camera will be triggered by its GPIO Input Signal when its state changes. (As for the more GPIO Signal setting, you may refer to [4.4.4 GPIO Tab](#)).

Each recording time-span is in accordance with the total value of Pre-event recording and Post event recording (in seconds).

Target: The video record may be stored in the SD card, provided to host by E-mail/FTP, activated GPIO Output Port as selected, or through all of them.

Event Alarm Settings by Video

(*Please note that there is no SD Card plugged in camera or the SD Card is not writable.)

Schedule / Period Recording

Motion (Link to [Motion Settings](#))

GPIO Input

Day:

Sun MON Tue WED Thu FRI Sat

Time:

Start : (hh:mm) End : (hh:mm)

Pre-event recording: Seconds

Post event recording: Seconds

Target:

SD card

E-mail / FTP

GPIO Output

If selects the E-mail/FTP as the target, the user has to set up and test the E-mail Settings or the FTP Settings in the following figure.

E-mail Settings

Recipient E-mail Address: (ex: rcpt@mail.com)

SMTP E-mail Server: (ex: mail.examples.com or 192.168.1.1)

Port: (0..65535)

User Name:

Password:

Sender E-mail Address: (ex: from@mail.com)

Use SSL-TLS: ▾

FTP Settings

FTP Server: (ex: ftp.domain.com or 192.168.1.1)

FTP Server Port: (0..65535)

User Name:

Password:

Path: (ex: \ftp\upload)

Upload to the root directory

Filename Prefix: (ex: event)

E-mail Settings: As for the settings of **SMTP Service**, kindly please contact with your E-mail service provider ◦ After you confirm all parameters are correct and working properly, you may enter them into the text area manually.

FTP Settings: As for the settings of **FTP Service**, kindly please contact with your FTP service provider ◦ While all parameters filled in Windows FTP Transferring Utility are correct and working properly under your Laptop or other PC, you may enter them into the text area manually.



© **Filename Prefix:** The filename will show as “prefix” “date” “time”.
EX: If set the prefix as “721Favi”, the filename will show as “721Favi_20170615151326.jpg”. The files will be stored in folders named by date and sub-folders named by time under the assigned Path.

4.4.3 Snapshot Tab

The **Snapshot** tabbed pane sets the Camera to take snapshot images when event is triggered.

The methods available for selection:

1. Always
2. Schedule
3. Motion
4. GPIO Input

The settings after event trigger:

1. Time Lapse: the duration (in seconds) to detect the motion again.
2. Single snapshot or 6 snapshots
3. Target: the methods and destination to store the snapshot files.

- **Always:** Under this method, the Camera automatically continuous to capture snapshots of the area under surveillance at every 1, 2 or 3 seconds interval (Time Lapse).

Target: The stream of accumulated snapshots may be stored in the SD Card, sent to host by E-mail or FTP, or through all of them.

The screenshot shows the 'Snapshot' tab selected in a settings menu. The title is 'Event Alarm Settings by Snapshot'. A red warning message states: '(*Please note that there is no SD Card plugged in camera or the SD Card is not writable.)'. Below this, there are two checked radio buttons: 'Always / Schedule' and 'Always'. Under 'Always / Schedule', there is a 'Time Lapse' setting with a dropdown menu set to '1' and the unit 'Seconds'. Under 'Always', there are three target options: 'SD card' (checked), 'E-mail' (unchecked), and 'FTP' (unchecked).

- **Schedule:** This method activates the Camera snapshot operation continuously when the defined days of the week and set time of the set days are met.

Time Lapse: The Camera will continuously capture snapshots of the area under surveillance at every 1, 2 or 3 seconds intervals.

Target: The stream of accumulated snapshots may be stored in the SD Card, sent to host by E-mail or FTP as preferred, or through all of them.

Motion Video **Snapshot** GPIO

Event Alarm Settings by Snapshot

(*Please note that there is no SD Card plugged in camera or the SD Card is not writable.)

Always / Schedule

Always

Schedule

Day:

Sun MON Tue WED Thu FRI Sat

Time:

Start : (hh:mm) End : (hh:mm)

Time Lapse: Seconds

Target:

SD card

E-mail

FTP

- Motion:** This method will trigger the Camera snapshot operation according to the set time interval (in seconds) whenever motion is detected within the defined days of the week and at the time of the set days.

The user can select “Single snapshot” or “6 snapshot” with 1 or 2 seconds interval (3 frames before and 3 frames after motion frame).

Target: The stream of accumulated snapshots may be stored in the SD Card, sent to host by E-mail or FTP, activated GPIO Output Port as preferred, or through all of them.

Motion
Video
Snapshot
GPIO

Event Alarm Settings by Snapshot

(*Please note that there is no SD Card plugged in camera or the SD Card is not writable.)

Always / Schedule

Motion (Link to [Motion Settings](#))

Trigger Pattern:

Only during

Sun
 MON
 Tue
 WED
 Thu
 FRI
 Sat

Time:

Start : (hh:mm)
 End : (hh:mm)

Interval: (minimum is 3 seconds)

Single snapshot
 6 snapshot with second interval (3 frames before and 3 frames after motion frame)

Target:

SD card
 E-mail
 FTP
 GPIO Output

- **GPIO Input:** On the defined days of the week and at certain time of the set days, the Camera will trigger its GPIO Input Signal according to the set time interval (in seconds) when its state changes.

The user can select “Single snapshot” or “6 snapshot” with 1 or 2 seconds interval (3 frames before and 3 frames after motion frame).

Target: The stream of accumulated snapshots may be stored in the SD Card, sent to host by E-mail or FTP, activated GPIO Output Port as preferred, or through all of them.

Event Alarm Settings by Snapshot

(*Please note that there is no SD Card plugged in camera or the SD Card is not writable.)

Always / Schedule

Motion (Link to [Motion Settings](#))

GPIO Input

Day:

Sun MON Tue WED Thu FRI Sat

Time:

Start : (hh:mm) End : (hh:mm)

Interval: (minimum is 3 seconds)

Single snapshot

6 snapshot with second interval (3 frames before and 3 frames after motion frame)

Target:

SD card

E-mail

FTP

GPIO Output

The stream of accumulated snapshots may be sent to host through E-mail, FTP, stored in the SD card, Remote Disk, activated GPIO Output Port; per selection or through all of them. When selected, the setup dialog for these methods will display is illustrated in the following figure.

If selects the E-mail/FTP as the target, the user has to set up and test the E-mail Settings or the FTP Settings in the following figure.

E-mail Settings

Recipient E-mail Address: (ex: rcpt@mail.com)

SMTP E-mail Server: (ex: mail.examples.com or 192.168.1.1)

Port: (0..65535)

User Name:

Password:

Sender E-mail Address: (ex: from@mail.com)

Use SSL-TLS: ▾

FTP Settings

FTP Server: (ex: ftp.domain.com or 192.168.1.1)

FTP Server Port: (0..65535)

User Name:

Password:

Path: (ex: \ftp\upload)

Upload to the root directory

Filename Prefix: (ex: event)

E-mail Settings: As for the settings of **SMTP Service**, kindly please contact with your E-mail service provider ◦ After you confirm all parameters are correct and working properly, you may enter them into the text area manually.

FTP Settings: As for the settings of **FTP Service**, kindly please contact with your FTP service provider ◦ While all parameters filled in Windows FTP Transferring Utility are correct and working properly under your Laptop or other PC, you may enter them into the text area manually.



© **Filename Prefix:** The filename will show as “prefix” “date” “time”.
EX: If set the prefix as “721Favi”, the filename will show as “721Favi_20170615151326.jpg”. The files will be stored in folders named by date and sub-folders named by time under the assigned Path.

4.4.4 GPIO Tab

The **GPIO** tabbed pane allows you to set GPIO Input Signal condition

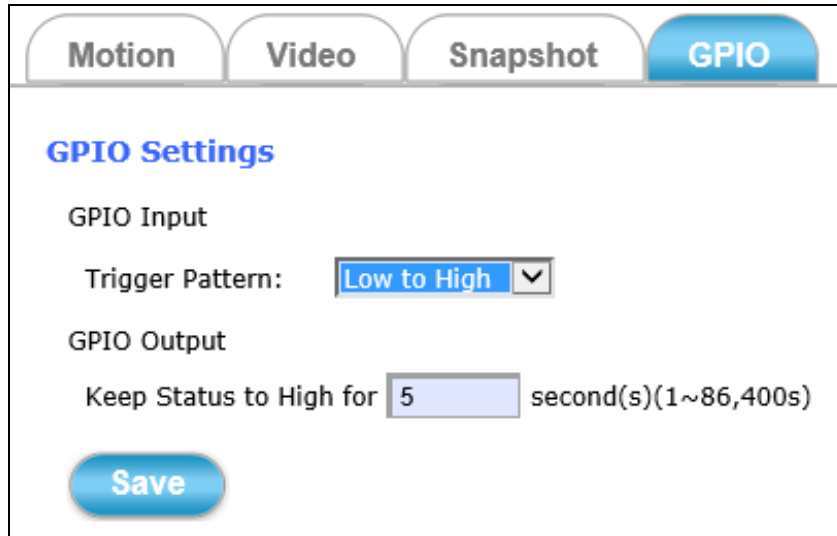

The screenshot shows a software interface with four tabs: Motion, Video, Snapshot, and GPIO. The GPIO tab is selected and highlighted in blue. Below the tabs, the text "GPIO Settings" is displayed in blue. Under "GPIO Input", there is a "Trigger Pattern:" label followed by a dropdown menu showing "Low to High" with a downward arrow. Under "GPIO Output", there is a "Keep Status to High for" label followed by a text input field containing the number "5" and the text "second(s)(1~86,400s)". At the bottom of the settings area is a blue "Save" button.

GPIO Input: To decide which kind of pattern would trigger event successfully.
Options: Low to High, High to Low, or State Change.

GPIO Output: To set how long the GPIO Output device would be kept active high status.



Save

Then click the **Save** button to take effect the change.

4.5 Local Storage Setup

Local Storage

Clicking the **Local Storage** button will display the following tabbed panes to provide information on existing local storage, such as disk size info, type, and status.

Setup

Live View

System

Network

Video & Audio

Event

Local Storage

Local Storage Playback

SD card management

SD card status: SD_DETACHED

Total size: 0 KBytes Free size: 0 KBytes

Used size: 0 KBytes Use(%): 0 %

Recording status:

SD card control:

Enable cyclic storage

Keep Free Space: 500 MB (30~500 MB)

(*Please note that there is no SD Card plugged in camera or the SD Card is not writable.)

Save Format Refresh

If recording is in progress when clicking the **Local Storage** button, a warning message will occur.



NOTE

Do **NOT** remove the micro SD card while Camera is in recording process.

4.5.1 Local Storage Tab

The **Local Storage** tabbed pane displays the SD card status. It shows the SD card total capacity (Total size), available memory (Free size), used memory (Used size) and used memory ratio (Use(%)).

It also displays the current Camera operation condition (Recording status) and provides “SD card control” option where user can select to allow the Camera to auto-overwrite earlier files in order to maintain the defined “Keep Free Space” memory size.

The screenshot shows the 'Local Storage' tab with the following details:

- SD card management**
- SD card status: SD_DETACHED
- Total size: 0 KBytes
- Free size: 0 KBytes
- Used size: 0 KBytes
- Use(%): 0 %
- Recording status:
- SD card control:
 - Enable cyclic storage
 - Keep Free Space: 500 MB (30~500 MB)
- (*Please note that there is no SD Card plugged in camera or the SD Card is not writable.)***
- Buttons: Save, Format, Refresh

Where:

Enable cyclic storage: Enable check box to allow auto-overwrite of earlier files in order to maintain the defined “Keep Free Space” memory size.

Save

: Click this button to save changes to the SD card control setting.

Format

: Click this button to format the SD memory card (take note of the message in red).

Refresh

: Click this button to refresh the SD card information.

4.5.2 Playback Tab

The **Playback** tabbed pane allows user to playback video and snapshot files stored in the SD memory card. These files were saved using the Event setup for video (see [Section 4.4.2](#)) and snapshots ([Section 4.4.3](#)) with the **SD card** check box enabled.

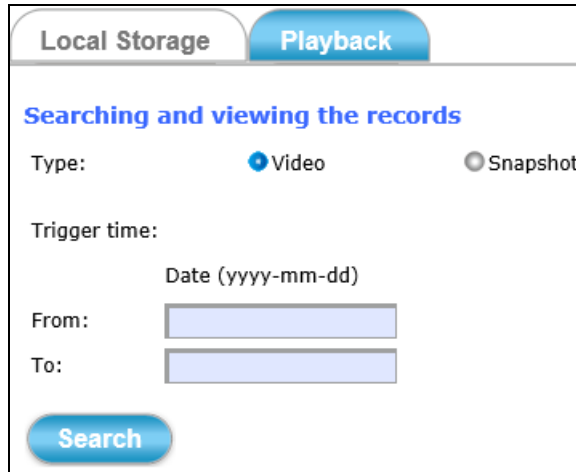

The screenshot shows the 'Playback' tab in a software interface. At the top, there are two tabs: 'Local Storage' and 'Playback', with 'Playback' being the active tab. Below the tabs, the text 'Searching and viewing the records' is displayed. Underneath, there are two radio buttons for 'Type': 'Video' (selected) and 'Snapshot'. Below that, there is a 'Trigger time:' section with a label 'Date (yyyy-mm-dd)'. This section contains two input fields: 'From:' and 'To:'. At the bottom of the form is a blue 'Search' button.

Playback of the stored videos or snapshots is performed from files recorded on particular date range as explained in the following figure.

- 1) Select **Type**: Click “**Video**” or “**Snapshot**”.
- 2) Give **Trigger time**: Enter a range date of begin and end.
- 3) Click **Search** button and the files recorded within the date range will display.

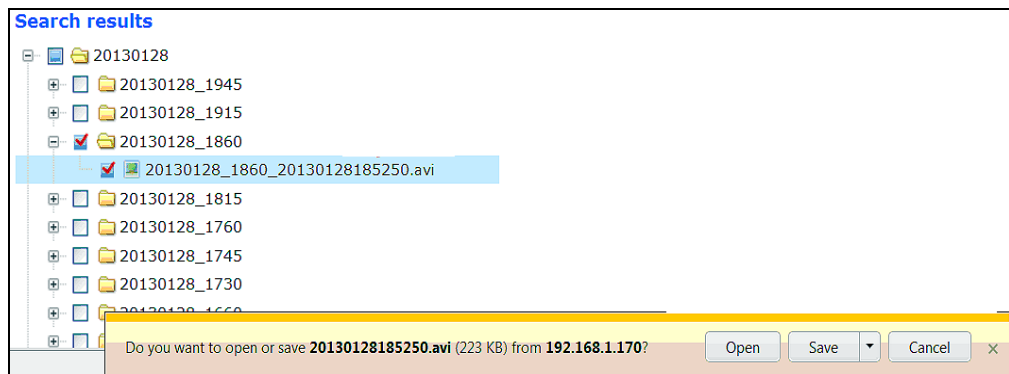

- 4) Select the file to playback and enable the corresponding check box. The dialog strip below will then pops up.
- 5) Click **Open** button will playback the file.
Click **Save** button will save file to a designated folder.

5 Appendix

5.1 Firmware Upgrade and Trouble Shooting

This section mainly will instruct you how to update camera firmware step by step and trouble shooting ().

1. Find the camera and open its Web-based UI via CAM FINDER utility.

(Don't know the CAM FINDER? Refer to [Chapter 2.3](#))

del Name	IP Address	MACAddress	Firmware	Subr
760D	192.168.13.004	00-04-29-49-c6-01	A1.0.1_0702_PLA	255.2
760D	192.168.13.002	00-04-29-08-e2-66	B1.0.1_0203	255.2
760D	192.168.13.011	00-34-56-23-59-88	1.0.1_0525	255.2
760D	192.168.13.008		2_0428_ROS	255.2
760D	192.168.13.005		2_1002h	255.2
760D	192.168.13.006		1206	255.2

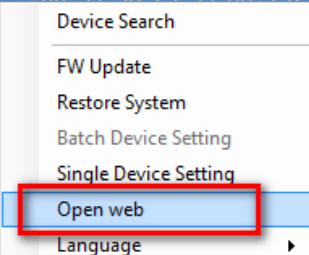

In this step, you may have following troubles:

- If below picture is always popped even NetcamViewer is downloaded and installed successfully in your PC.

Please help to **check if your IE Browser version is 11 first.**

If it is yes, please kindly refer to the below steps to enable Compatible View settings of IE 11 Browser.

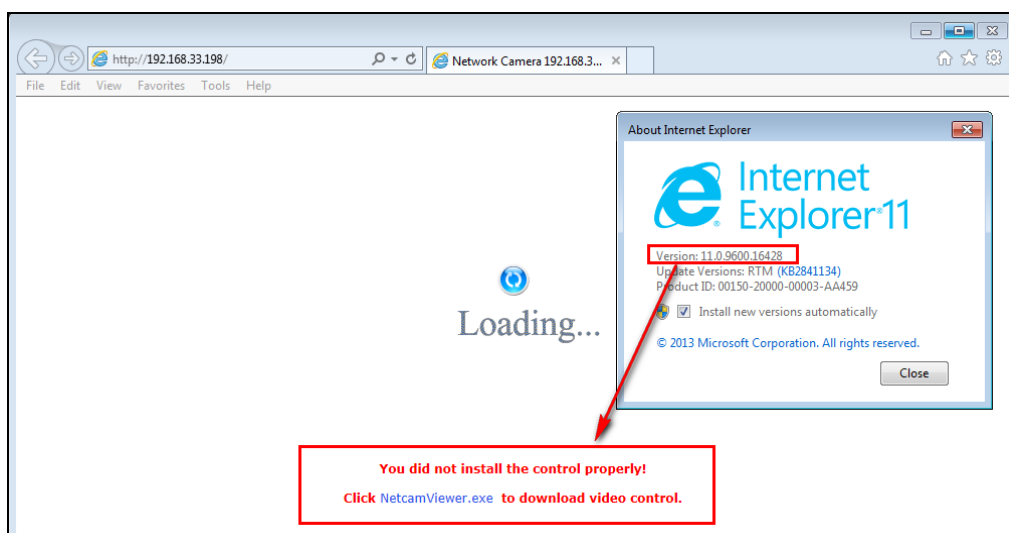

Find Tools icon and then select **Compatibility View settings**.

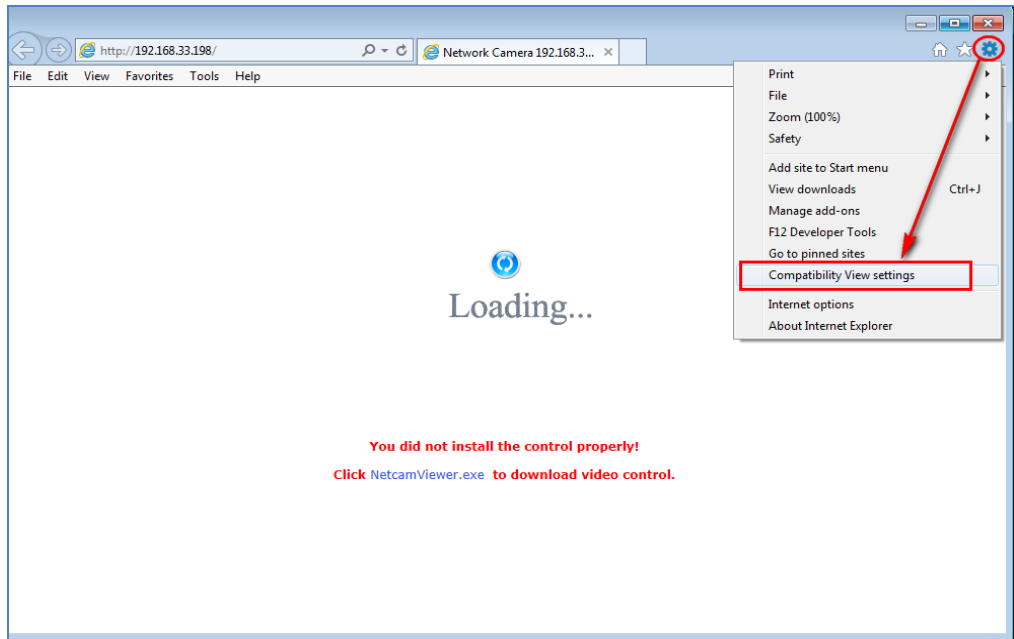

Or

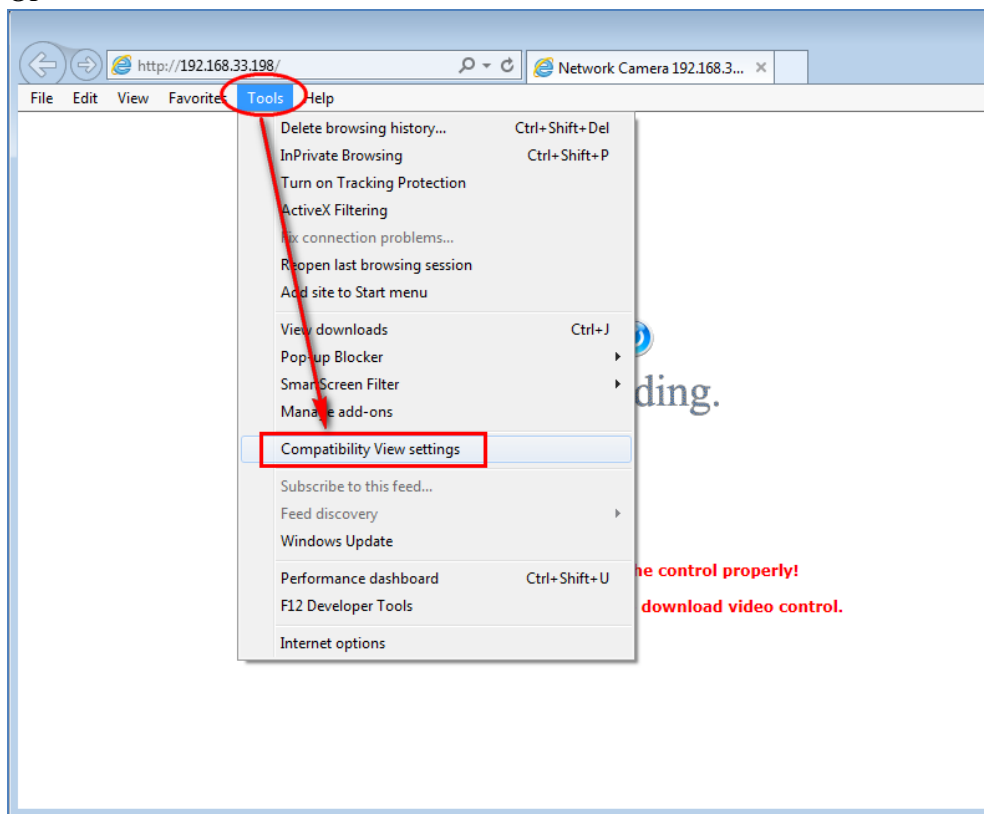

Click **Add** button to add camera webpage as a compatible website.

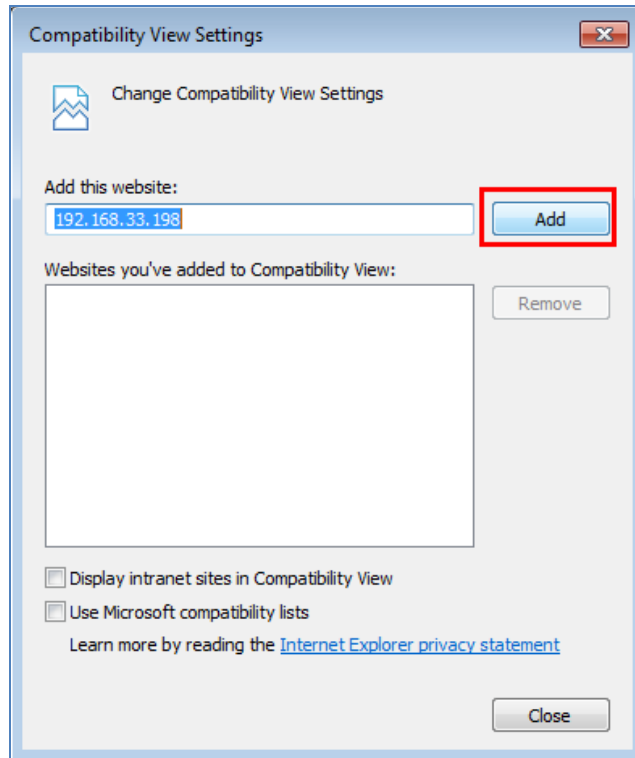

After successful adding, camera webpage should be set as compatible view website.

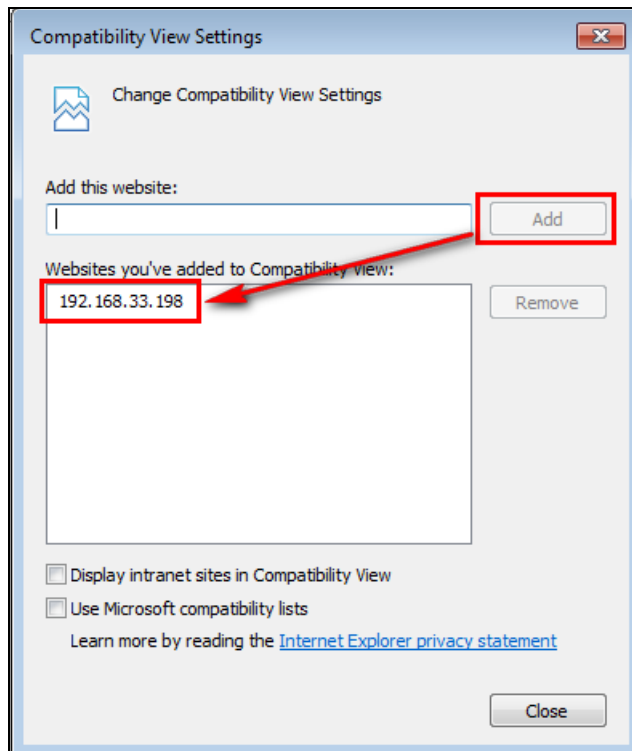

Then camera webpage would be refreshing real-time and starting to load camera webpage.

Click **Allow** button to enable NetcamViewer component running...

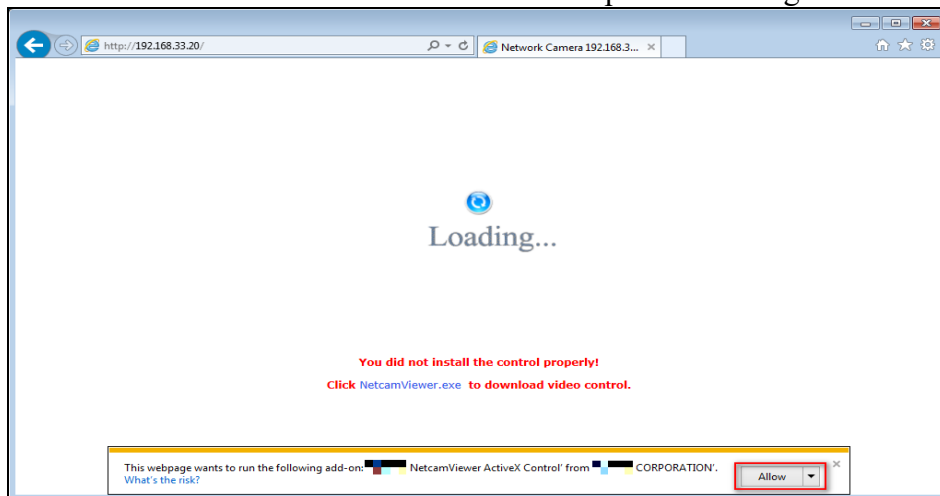

Manual enter camera's username/password to pass authentication.

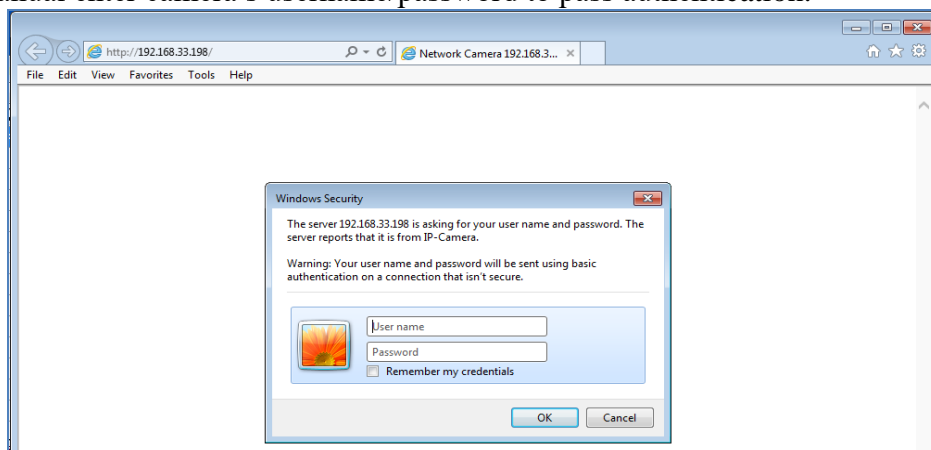

Camera live stream is successful playing in IE11 Browser

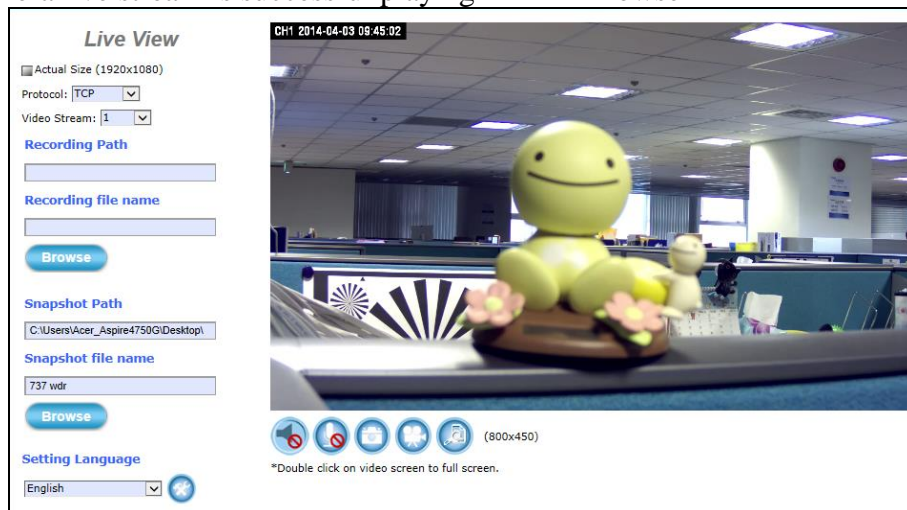



- If during the NetcamViewer installation, the error message **“opening file for writing C:\Windows\system32\LibPMD.dll”** is always popped, kindly please turn off all browser windows, include CDWizard application, and then try NetcamViewer installation again.

So before NetcamViewer installation, please make sure there's no “iexplore” process running in Windows Task Manager Window.

If there is “iexplore” process existing, select **“End Process”** to force its stop.

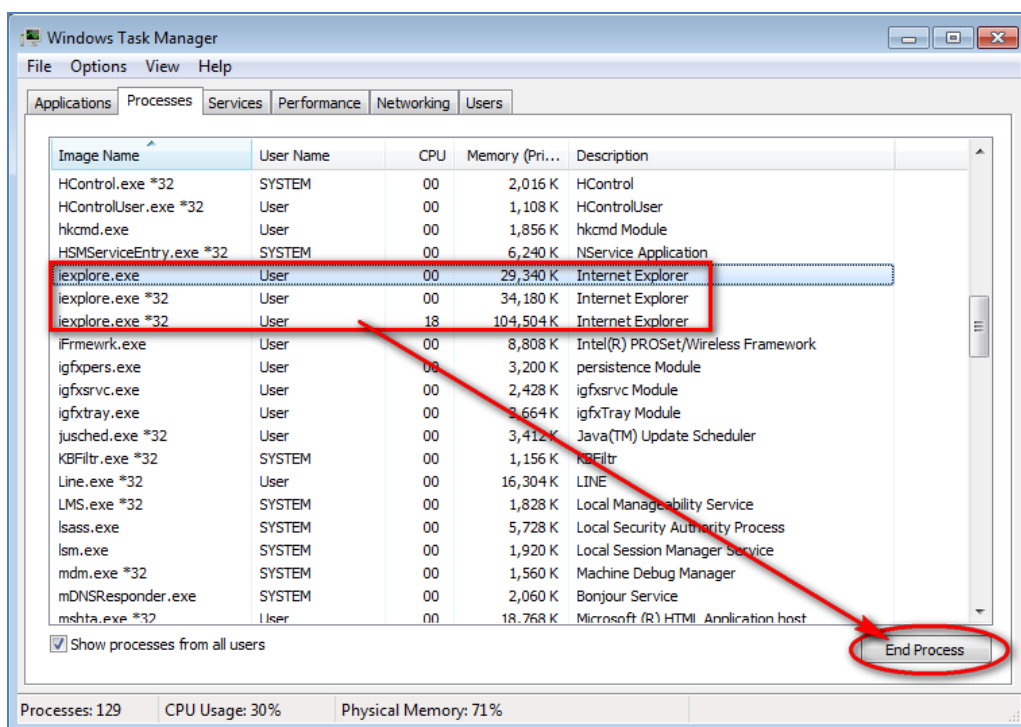



During NetcamViewer installation, you may see below prompt windows are always popped.

This will mainly remind you to **close all running browser applications** and then press **“OK”** button to continue NetcamViewer installation.

Or these two windows will pop continuously until all browsers are closed.

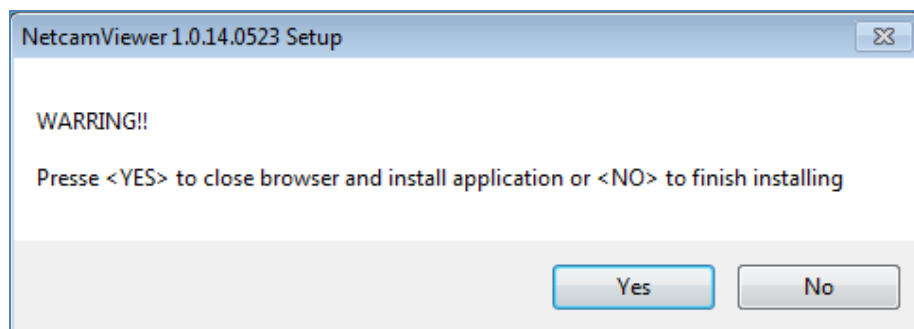
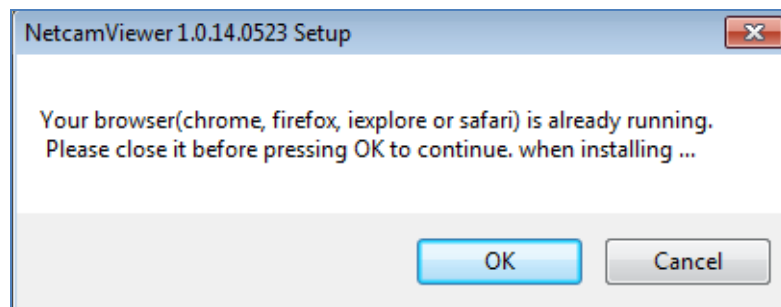

-
2. Manual input username and password of the camera to pass login authentication of camera webpage. (Default username and password are admin and admin.)
 3. After Live View page is entering successfully, find the **“SETUP”** button. Clicking it could change or update more Camera settings.

The screenshot displays the 'Live View' configuration interface. At the top, the title 'Live View' is centered. Below it, there is a checkbox for 'Actual Size (2048x1536)'. The 'Protocol' is set to 'TCP' and 'Video Stream' is set to '1', both shown as dropdown menus. The 'Recording Path' section includes a text input field and a 'Browse' button. The 'Recording file name' section includes a text input field and a 'Browse' button. The 'Snapshot Path' section includes a text input field. The 'Snapshot file name' section includes a text input field and a 'Browse' button. The 'Setting Language' section shows 'English' as the selected language. A blue gear icon, representing the 'Setup' button, is located at the bottom right of the form and is highlighted with a red square.

4. Find **Maintenance** Tab of Camera Setup **System** Webpage. – [Chapter 4.1.4](#).

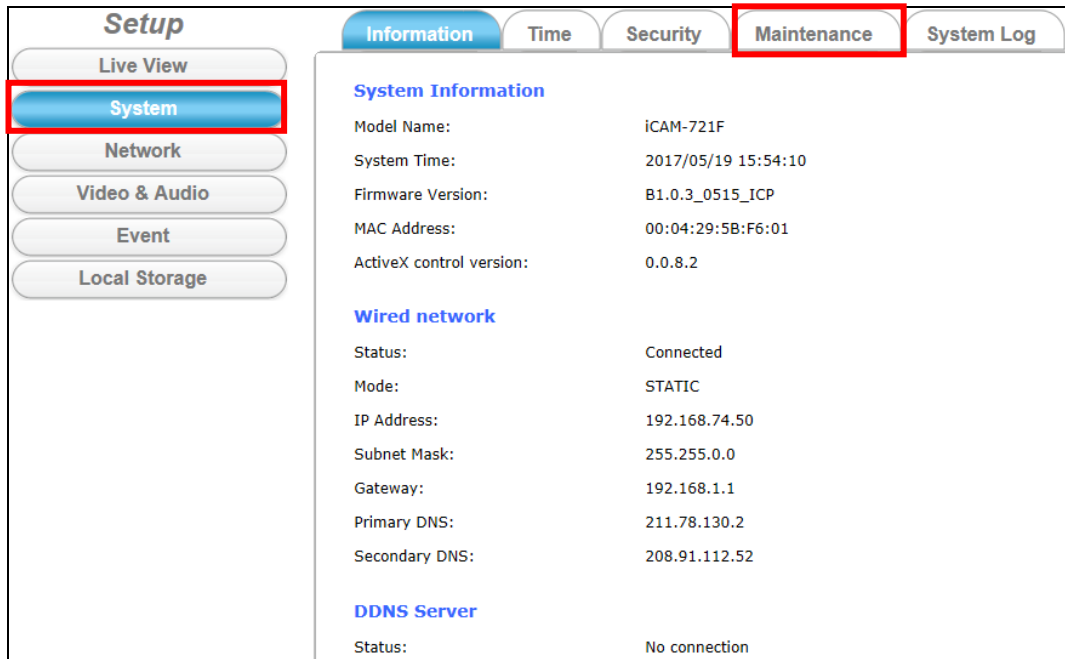

5. In order to have the best performance with Camera, kindly please ask for distributor/dealer's help to get the latest firmware version downloading.
6. After downloading it, click the **Browse** button to open the file open dialog for firmware choosing.

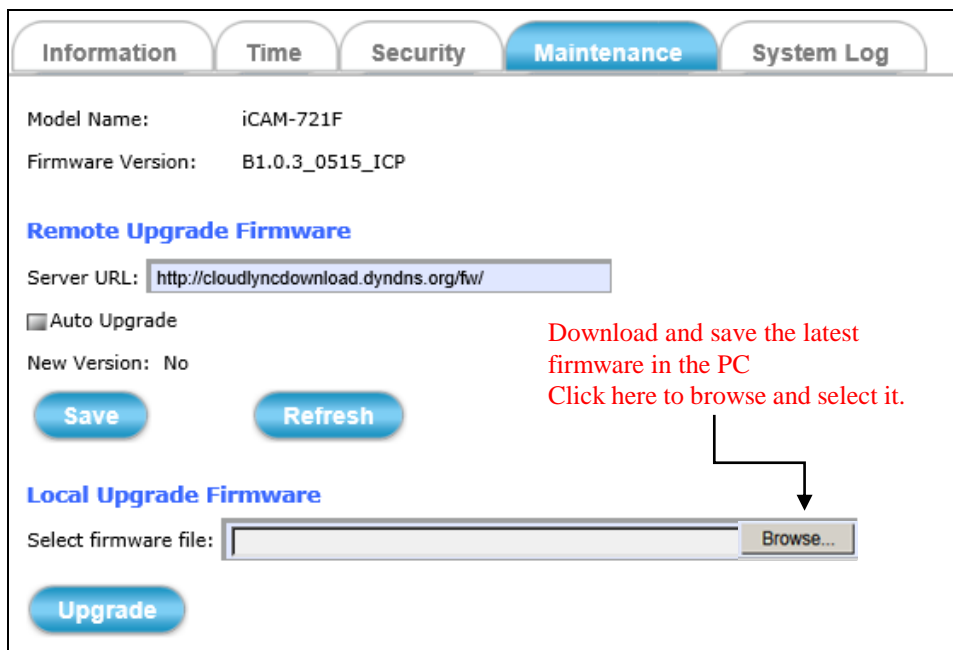

Select the **appropriate** firmware file from its folder in PC and then click **Open** button to choose it.

※ **Please specify the correct firmware version mapped with your camera to upgrade, or there will be danger to damage camera system.**

7. Click the **Upgrade** button and then one prompt window will pop to tell you “wait about 30 seconds to stop all processes!”

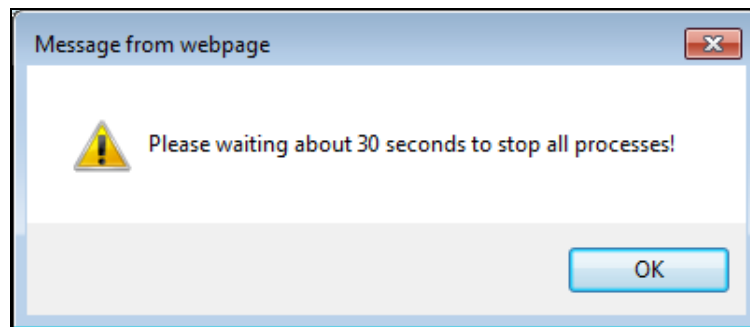

8. Click the **OK** button to exit the window. Then you will see Camera Webpage is reloading, it means all processes of camera are stopping at the same time.



9. After all processes are stopped, the camera will start to upgrade the firmware you chose.

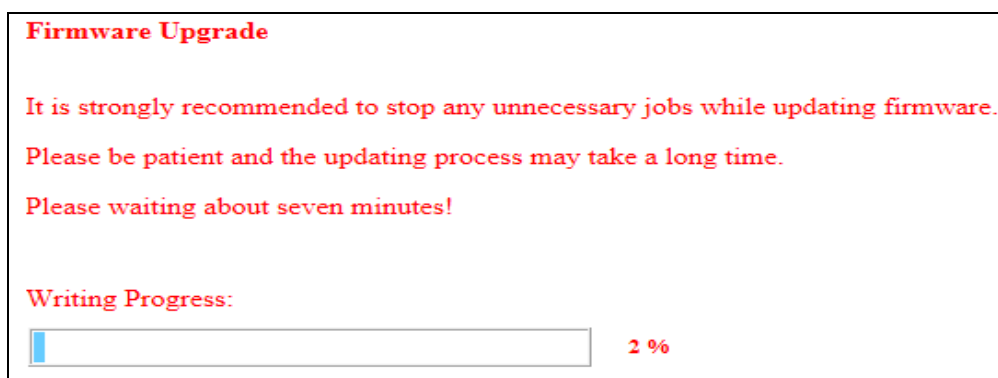

10. Please don't power off camera or do any unnecessary jobs during firmware upgrade.

Until the process goes to 100%, there will be messages popped to suggest you restart the Web Browser.

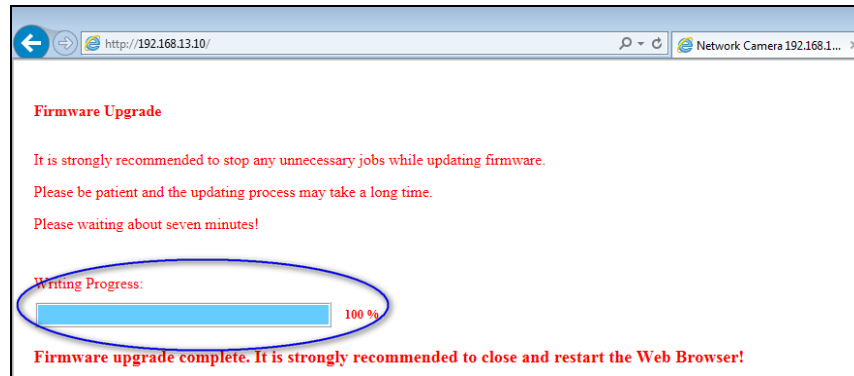

11. While the OK button is clicked, the camera webpage connection will be closed. And then you have to re-login again.

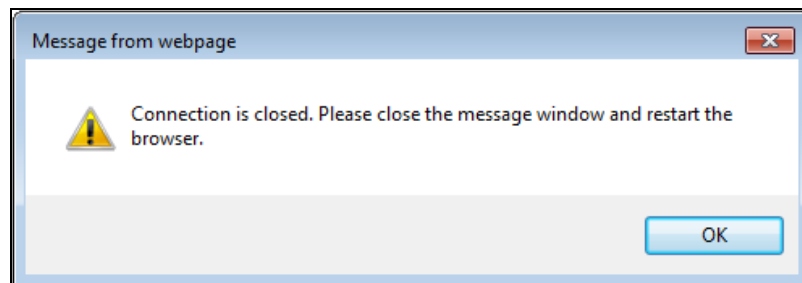

12. After camera Web-based UI is re-login successfully, go to Information Tab of Camera Setup Webpage to check if the firmware version is different with before; or check if the firmware version is the same with distributor/dealer provided.

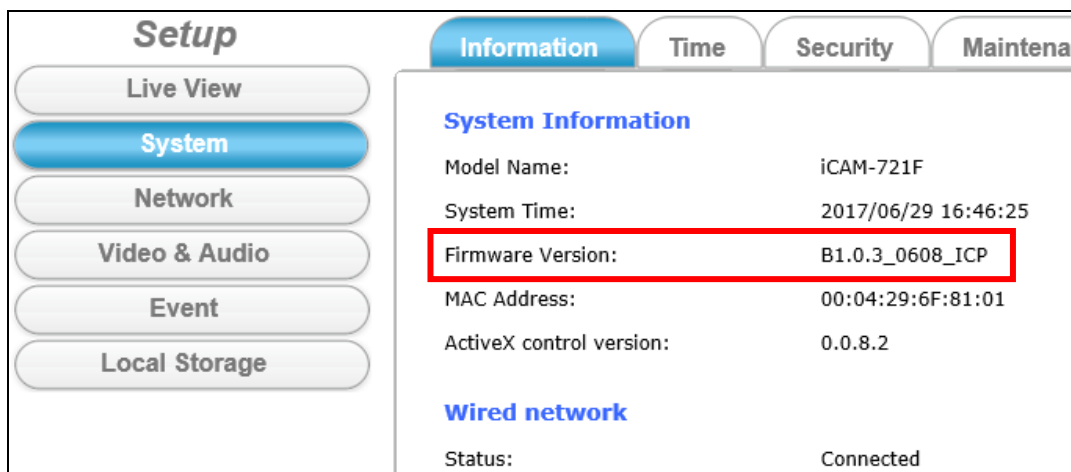

5.2 How to let camera to do Hardware Reset

In some cases, such as user forget login username & password they've changed before; or modify some settings to cause camera displayed image improperly; or camera system is no response & hang to the user's operation... etc., you may need to let camera to do Hardware Reset. After that, camera could reboot, operate and re-configure. The default iCAM setting after reset:

IP: 192.168.255.2 (Default Username/Password: admin/admin)

Submask: 255.255.0.0

Gateway address: 192.168.0.1

DNS Server address: 8.8.8.8

The hardware reset steps are as the following:

- 1) Please make sure camera is power on first.
- 2) Refer the below **GPIO Port** pin definition table of the cable; connect **Default Setting(5)** and **GND(4)** pins to short, remove the connection 10 seconds later.

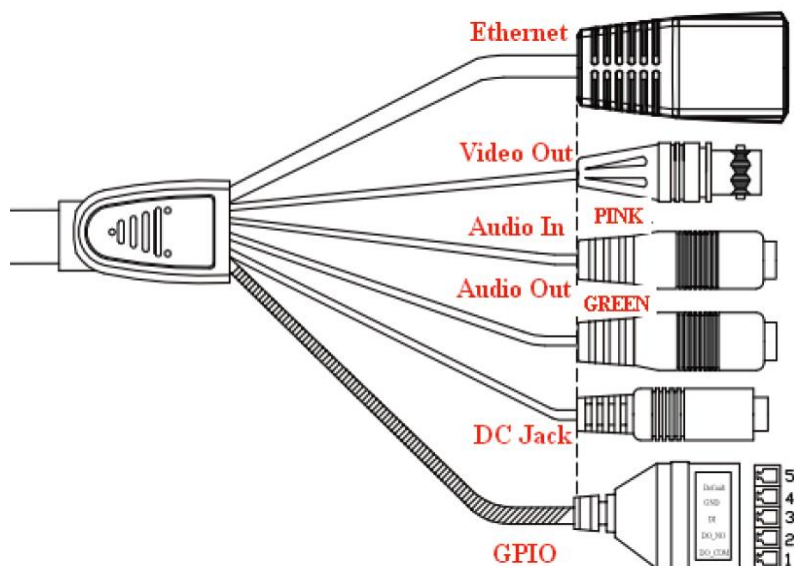

Pin Number	Pin Definition
1	DO_COM
2	DO_NO
3	DI
4	GND
5	Default Setting

Pin	Function	Pin Description
1	DO_COM	<p>DO: Digital Output; each digital output pin to COM (Pin1) is a photo-coupled relay on Normal Open status. External device can directly connect to the terminals. However the current that will go through the 2 nodes must not exceed 130mA. An external “Relay” can also be connected to the terminals as an implementation. In this case, current (or/and voltage) limitation is specified by the external Relay.</p>
2	DO_NO	
3	DI	<p>DI: Digital Input; Only one set is designed in this Camera Model. The internal device is also photo-coupled electrical relay; and the external device can be simply an On/Off switch. Each set of On/Off switch can be connected as one trigger source.</p>
4	GND	<p>Default Setting: Short Pin4 and Pin5 with a wire PIN with a short wire to revert to factory default settings. Break the short when the LED starts quick flashing, and then camera will reboot automatically a few minutes later.</p>
5	Default Setting	